

# PRICING CATALOGUE

# 2023



HVAC  
Products



Hardware  
Products



Plumbing  
Products



Building Service  
Products



Air Conditioning  
Products



Electrical  
Products

# **TRADE** **STORE**

**Arrow Sales Pty Ltd**

**Tradestore** is an online supplier of a range of trade and DIY supplies. Tradestore.com.au is the online store for Arrow Sales Pty Ltd. It is a family-owned and operated company. It has been supplying goods and products throughout Australia since 2000.

We pride ourselves on our expertise and service regarding products for the building industry. Our motto is “Offering Trade Solutions” and “Connecting the Trade”.

We stock, wholesale, manufacture and import a wide range of products. We can offer quality products and very competitive prices.

We aim to be the connection between products required and short time constraints. We try to save you time getting your goods to you, sending them to your address, site and most importantly, on time.

Combine this with our high service standards, a vast range of brands and the company’s price guarantee. Consumers can buy with confidence from Arrow Sales/ tradestore.com.au.

**Kind Regards,**

**Dale Richardson**  
**Managing Director**



Ph: 02 9525 0970

Fax: 02 9540 2899

Email: [orders@arrowsales.com.au](mailto:orders@arrowsales.com.au)

Please Note All Prices Are GST Exclusive

## Product Listing

## Details

## Products

### SECTION A

Air Filtration Products



### SECTION B

Copper Pipe and Fittings



### SECTION C

Air Conditioning Drainage



### SECTION D

Electrical Products



### SECTION E

Pressure Pipe Fittings



### SECTION F

Fire Solutions

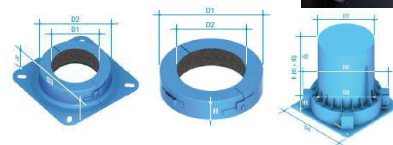

### SECTION G

Pipe Supports and Brackets



### SECTION H

Ventilation



### SECTION I

Fasteners and Screws







[www.airfiltersupplies.com.au](http://www.airfiltersupplies.com.au)

Ph: 02 9525 0970



Fax: 02 9540 2899

Email: [orders@arrowsales.com.au](mailto:orders@arrowsales.com.au)

Please Note All Prices Are GST Exclusive

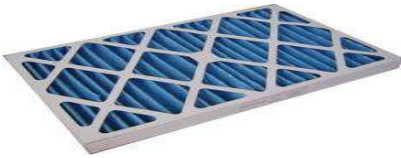
## G4/F4 CARDBOARD FILTERS

25mm (1") Cardboard Filters	Width mm	Height mm	Width mm	Height mm	Thick mm	Code	Pick-Up \$/each	Qty Pkt
	12	24	295	595	25	G4122425	\$15.36	12
	14	20	349	495	25	G4142025	\$18.00	12
	14	25	349	629	25	G4142525	\$18.00	12
	16	20	395	495	25	G4162025	\$18.00	12
	16	25	395	629	25	G4162525	\$21.60	12
	18	24	451	595	25	G4182425	\$24.00	12
	18	25	457	635	25	G4182525	\$22.14	12
	20	20	495	495	25	G4202025	\$23.04	12
	20	24	495	595	25	G4202425	\$20.50	12
	20	25	495	629	25	G4202525	\$25.44	12
	24	24	595	595	25	G4242425	\$24.24	12

50mm (2") Cardboard Filters	Width mm	Height mm	Width mm	Height mm	Thick mm	Code	Pick-Up \$/each	Qty Pkt
	10	20	254	495	50	G42544955	\$15.36	12
	12	12	295	295	50	G42952955	\$17.82	12
	12	14	295	349	50	G42953555	\$17.52	12
	12	16	295	395	50	G42953955	\$17.00	12
	12	20	295	495	50	G42954955	\$17.82	12
	12	24	295	595	50	G42955955	\$14.16	12
	13	14	320	349	50	G43203495	\$20.87	12
	14	15	349	375	50	G43493805	\$17.52	12
	14	17	349	430	50	G43494305	\$17.52	12
	14	20	349	495	50	G43494955	\$17.85	12
	14	24	349	595	50	G43495955	\$17.85	12
	14	25	349	629	50	G43496295	\$18.90	12
	15	20	375	495	50	G43754955	\$21.60	12
	16	16	395	395	50	G43953955	\$19.78	12
	16	18	395	460	50	G43954605	\$15.80	12
	16	20	395	495	50	G43954955	\$15.36	12
	16	24	395	595	50	G43955955	\$21.12	12
	16	25	395	629	50	G43956295	\$18.90	12
	18	20	451	495	50	G44514955	\$19.92	12
	18	24	451	595	50	G44515955	\$20.40	12
	18	25	451	629	50	G44516295	\$24.57	12
	20	20	495	495	50	G44954955	\$19.68	12
	20	24	495	595	50	G45954955	\$23.76	12
	20	25	495	629	50	G44956295	\$29.97	12
	20	30	495	762	50	G44957625	\$30.24	12
	24	24	595	595	50	G45955955	\$20.88	12
25	25	629	629	50	G46296295	\$35.76	12	
25	30	629	762	50	G46297625	\$44.64	12	

Ph: 02 9525 0970

Fax: 02 9540 2899

Email: [orders@arrowsales.com.au](mailto:orders@arrowsales.com.au)

## G4/F4 CARDBOARD FILTERS

100mm (4") Cardboard Filters	Width mm	Height mm	Width mm	Height mm	Thick mm	Code	Pick-Up \$/each	Qty Pkt
	12	24	295	595	100	G4122495	\$22.26	6
	16	16	395	395	100	G4161695	\$30.24	6
	16	20	395	495	100	G4162095	\$24.95	6
	16	24	395	595	100	G4162495	\$34.00	6
	16	25	395	629	100	G4162595	\$36.33	6
	18	24	451	595	100	G4182495	\$39.06	6
	20	20	495	495	100	G4202095	\$32.76	6
	20	24	495	595	100	G4202495	\$34.86	6
	20	25	495	629	100	G4202595	\$43.47	6
	24	24	595	595	100	G4242495	\$37.80	6
	25	29	629	735	100	G4252995	\$54.75	6
	28	30	711	762	100	G4283095	\$69.50	6

## G4/ HIGH EFFICIENCY CARDBOARD FILTERS

High Efficiency Cardboard Filter	Width mm	Height mm	Width mm	Height mm	Efficiency En779	Code	Pick-Up \$/each	Qty Pkt
	24	24	594	594	F5	G5595595	POA	12
	12	24	290	594	F5	G5295595	POA	12
	24	24	594	594	F6	G6595595	POA	12
	12	24	290	594	F6	G6295595	POA	12
	24	24	594	594	F8	G8595595	POA	12
	12	24	290	594	F8	G8295595	POA	12
	24	24	594	594	F9	G9595595	\$35.00	12

CARBON FILTER	Width mm	Height mm	Width mm	Height mm	Thick mm	Code	Pick-Up \$/each	Qty Pkt
	24	24	595	595	50	G4C595595	\$32.75	12



## G4/ HIGH EFFICIENCY CARDBOARD FILTERS



G4 Cardboard Filters	Perimeter Size		Thick mm	Code	Pick-Up \$/each	Qty Pkt
	0	800				
	0	800	10	FILTER800	\$24.30	1
	800	1800	10	FILTER1800	\$43.20	1
	1800	2400	10	FILTER2400	\$56.70	1
	2400	3440	10	FILTER3440	\$70.20	1

N75 HIGH EFFICIENCY PANEL FILTER	Width mm	Height mm	Thick mm	Code	Pick-Up \$/each	Qty Pkt
	0	800	10	FILTER75N800	POA	1
	800	1800	10	FILTER75N1800	POA	1
	1800	2400	10	FILTER75N2400	POA	1
	2400	3440	10	FILTER75N3440	POA	1

N95 HIGH EFFICIENCY PANEL FILTER	Width mm	Height mm	Thick mm	Code	Pick-Up \$/each	Qty Pkt
	0	800	10	FILTER95N800	POA	1
	800	1800	10	FILTER95N1800	POA	1
	1800	2400	10	FILTER95N2400	POA	1
	2400	3440	10	FILTER95N3440	POA	1

## G4/F4 DISPOSABLE SERVICE PLEATS

50mm (2") Disposable Pleats	Width	Height	Width	Height	Thick	Code	Pick-Up \$/each	Qty Pkt
	mm	mm	mm	mm	mm			
 	12	20	295	495	50	DSP295495	\$18.80	30
	12	24	295	595	50	DSP295595	\$19.75	30
	16	16	395	395	50	DSP395395	\$17.00	30
	16	20	395	495	50	DSP395495	\$18.25	30
	16	24	395	595	50	DSP395595	\$19.75	30
	16	25	395	629	50	DSP395629	\$20.00	30
	16	30	395	750	50	DSP395750	\$22.25	30
	20	12	495	295	50	DSP495295	\$12.75	30
	20	14.5	495	368	50	DSP495368	\$14.00	30
	20	16	495	395	50	DSP495395	\$14.50	30
	20	20	495	495	50	DSP495495	\$15.50	30
	20	24	495	595	50	DSP495595	\$18.00	30
	20	25	495	629	50	DSP495629	\$21.50	30
	20	30	495	750	50	DSP495750	\$24.75	30
	24	12	595	295	50	DSP595295	\$15.50	30
	24	16	595	395	50	DSP595395	\$16.25	30
	24	18	595	444	50	DSP595444	\$16.50	30
	24	20	595	495	50	DSP595495	\$17.00	30
	24	24	595	595	50	DSP595595	\$17.75	30
	24	30	595	750	50	DSP595750	\$41.10	30
25	12	629	295	50	DSP629295	\$15.00	30	
25	16	629	395	50	DPS629395	POA	30	
25	20	629	495	50	DSP629495	\$17.50	30	
25	24	629	595	50	DSP629595	\$18.50	30	
25	30	629	762	50	DSP629762	\$21.25	30	

100mm (4") Disposable Pleats	Width	Height	Width	Height	Thick	Code	Pick-Up \$/each	Qty Pkt
	mm	mm	mm	mm	mm			
 	16	20	395	495	100	DSP16204	\$23.75	20
	16	24	395	595	100	DSP16244	\$25.75	20
	16	25	395	629	100	DSP16254	\$26.75	20
	20	12	495	295	100	DSP20124	\$19.50	20
	20	20	495	495	100	DSP20204	\$22.00	20
	20	24	495	595	100	DSP20244	\$23.50	20
	20	25	495	629	100	DSP20254	\$25.25	10
	24	12	595	295	100	DSP24124	\$22.75	10
	24	16	595	395	100	DSP24164	\$23.50	10
	24	24	595	595	100	DSP24244	\$29.75	10
	25	12	629	295	100	DSP25124	\$24.50	10
	25	20	629	495	100	DSP25204	\$27.25	10
	25	24	629	595	100	DSP25244	\$29.75	10
	25	30	629	595	100	DSP25304	\$32.50	10

Ph: 02 9525 0970

Fax: 02 9540 2899

Email: orders@arrowsales.com.au

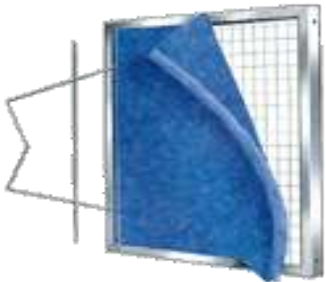

## F4/G4 PRIMARY FILTERS

G4 Pad Filters	Width mm	Height mm	Depth mm	Code	\$/each	Qty Pkt
	300	500	25	P500300	\$6.75	1
	410	455	25	P455410	\$6.75	1
	510	455	25	P510455	\$6.75	1
	510	510	25	P510510	\$6.75	1
	510	590	25	P590510	\$6.75	1
	510	610	25	P610510	\$6.75	1
	595	595	25	P610510	\$6.75	1
	610	610	25	P610610	\$6.75	1

Bulk Media Rolls	Width mm	Height mm	Depth mm	Code	\$/each	Qty Pkt	Color
	2.1	18	65	MEDIAEC1	\$60.00	1	White
	21	18	20	MEDIAF4A	\$486.00	1	White
	1	10	20	MEDIAH12	\$280.00	1	White
	2.1	10	20	MEDIAH12	\$280.00	1	White
	2.1	10	20	MEDIAH12	\$280.00	1	Grey
	655	8		MEDIAF7	\$20.00	1	
	655	8		MEDIAF9	\$30.00	1	
	2.1	10	20	MEDIAH22	\$487.59	1	
	2.1	10	40	MEDIAH24	\$520.96	1	
	1	1		MEDIAMIS	\$16.00	1	

### Grade: F4 Semi-Washable White

F4 Deep Bed Filters - Incl. Frame	Width mm	Height mm	Depth mm	Code	\$/each	Qty Pkt	
	595	595	570	DBF666	\$35.20	1	
	595	295	570	DBF636	\$42.23	1	
	595	595	350	DBF663	\$52.33	1	
	595	295	350	DBF633	\$40.12	1	
	Specifications						
	Width	Height	Depth	Pockets		L/S	
	595	595	945	570	3	945	
	595	295	470	570	2	470	
	595	595	945	350	3	945	
	595	295	470	350	2	470	

### All F4 Filters Have A Sturdy Aluminium Frame

Galvanised Mounting Frames - Incl Gasket	Width mm	Height mm	Depth mm	Code	\$/each	Qty Pkt
	300	600	50	F600300	\$42.00	1
	305	610	50	F305610	\$39.00	1
	610	610	50	F610610	\$36.00	1
	600	600	50	F600600	\$36.00	1
	405	635	50	F405635	POA	1
	508	508	50	F508508	POA	1
	508	610	50	F508610	POA	1
	508	635	50	F508635	POA	1

Ph: 02 9525 0970

Fax: 02 9540 2899

Email: orders@arrowsales.com.au

## MEDIUM EFFICIENCY FILTERS

F5 Medium Efficiency Pocket Filter	Width mm	Height mm	Depth mm	Code	Pockets	\$/each	Qty Pkt
	595	295	560	MF5636	3	\$34.32	
	595	595	380	MF5663	6	\$45.26	
	287	595	380	MF5363	3	POA	
	595	295	380	MF5633	3	\$33.22	
	595	595	560	MF56661	6	POA	
	595	595	560	MF5666	8	\$76.00	

F6 Medium Efficiency Pocket Filter	Width mm	Height mm	Depth mm	Code	Pockets	\$/each	Qty Pkt
	595	595	380	MF6663	6	\$58.05	
	287	595	380	MF6363	3	POA	
	595	295	380	MF6633		\$40.35	
	595	595	560	MF66661	10	POA	
	595	595	560	MF6666	8	\$36.92	
	595	595	570	MF6636		\$23.12	
	595	595	560	MF6666	8	\$36.92	

F7 Medium Efficiency Pocket Filter	Width mm	Height mm	Depth mm	Code	Pockets	\$/each	Qty Pkt
	595	295	380	MF7633	3	\$39.56	
	595	295	595	MF7636	6	\$49.00	
	595	595	380	MF7663	6	\$48.45	
	287	595	380	MF7363	3	POA	
	595	595	560	MF76661	8	POA	
	595	595	595	MF7666	8	\$68.48	

## MEDIUM EFFICIENCY FILTERS

F8 Medium Efficiency Pocket Filter	Width mm	Height mm	Depth mm	Code	Pockets	\$/each	Qty Pkt
	595	595	380	MF8663	6	POA	
	287	595	380	MF8363	3	POA	
	595	595	560	MF86661	10	POA	
	595	595	560	MF8666	8	POA	

F9 Medium Efficiency Pocket Filter	Width mm	Height mm	Depth mm	Code	Pockets	\$/each	Qty Pkt
	295	595	560	MF9366	6	\$155.00	

## HEPA FILTERS

Mini-Pleat HEPA Filter								
Width mm	Height mm	Width mm	Height mm	Depth mm	Efficiency En779	Code	\$/each	Qty Pkt
12	24	305	610	70	H11	MFHEPAH11-30561070	POA	
24	24	610	610	70		MFHEPAH11-61061070	POA	
36	24	915	610	70		MFHEPAH11-91561070	POA	
	24	1220	610	70		MFHEPAH11-122061070	POA	
12	24	305	610	70	H13	MFHEPAH13-30561070	POA	
24	24	610	610	70		MFHEPAH13-61061070	POA	
36	24	915	610	70		MFHEPAH13-91561070	POA	
48	24	1220	610	70		MFHEPAH13-122061070	POA	
12	24	305	610	70	U15	MFHEPAU15-30561070	POA	
24	24	610	610	70		MFHEPAU15-61061070	POA	
36	24	915	610	70		MFHEPAU15-91561070	POA	
48	24	1220	610	70		MFHEPAU15-122061070	POA	



High Volume HEPA Filter								
Width mm	Height mm	Width mm	Height mm	Depth mm	Efficiency En779	Code	\$/each	Qty Pkt
24	24	610	610	292	MFHEPA4V	MFHEPAH11-610610292	POA	
24	24	610	610	292	MFHEPA6V	MFHEPAH11-610610292	POA	
12	24	305	610	292	MFHEPA3V	MFHEPAH11-305610292	POA	
24	24	610	610	292	MFHEPA4V	MFHEPAH13-610610292	POA	
24	24	610	610	292	MFHEPA6V	MFHEPAH13-610610292	POA	
12	24	305	610	292	MFHEPA3V	MFHEPAH13-305610292	POA	
24	24	610	610	292	MFHEPA4V	MFHEPAH14-610610292	POA	
24	24	610	610	292	MFHEPA6V	MFHEPAH14-610610292	POA	
12	24	305	610	292	MFHEPA3V	MFHEPAH14-305310292	POA	





## HVAC Filters

V-Type ASHRAE Filter								
Width mm	Height mm	Width mm	Height mm	Depth mm	Efficiency En779	Code	\$/each	Qty Pkt
12	24	305	610	292	F6	MFHVACF63V	POA	
24	24	610	610	292		MFHVACF64V	POA	
24	24	610	610	292		MFHVACF65V	POA	
	24	610	610	292		MFHVACF66V	POA	
12	24	305	610	292	F7	MFHVACF73V	POA	
24	24	610	610	292		MFHVACF74V	POA	
24	24	610	610	292		MFHVACF75V	POA	
24	24	610	610	292		MFHVACF76V	POA	
12	24	305	610	292	F8	MFHVACF83V	POA	
24	24	610	610	292		MFHVACF84V	POA	
24	24	610	610	292		MFHVACF85V	POA	
12	24	305	610	292		MFHVACF86V	POA	



## V FORM FILTERS

50mm V-Form Washable F4	Area m2	Code	\$/each	Qty Pkt
	up to 0.09m <sup>2</sup>	VF150xHxW	\$ 81.00	5
	up to 0.16m <sup>2</sup>	VF250xHxW	\$ 73.36	5
	up to 0.25m <sup>2</sup>	VF350xHxW	\$ 97.20	5
	up to 0.36m <sup>2</sup>	VF450xHxW	\$ 87.32	5
	up to 0.49m <sup>3</sup>	VF550xHxW	\$ 135.73	5
	up to 0.64m <sup>2</sup>	VF650xHxW	\$ 144.05	5
	up to 0.81m <sup>2</sup>	VF750xHxW	\$ 175.53	5
	up to 1.00m <sup>2</sup>	VF850xHxW	\$ 183.25	5
	up to 1.21m <sup>2</sup>	VF950xHxW	\$ 540.00	5
	up to 1.44m <sup>2</sup>	VF1050xHxW	\$ 199.29	5

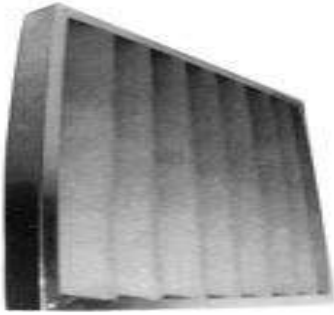
100mm V-Form Washable F4	Area m2	Code	\$/each	Qty Pkt
	up to 0.09m <sup>2</sup>	VF1100xHxW	\$ 106.62	5
	up to 0.16m <sup>2</sup>	VF2100xHxW	\$ 106.62	5
	up to 0.25m <sup>2</sup>	VF3100xHxW	\$ 112.86	5
	up to 0.36m <sup>2</sup>	VF4100xHxW	\$ 118.80	5
	up to 0.49m <sup>2</sup>	VF5100xHxW	\$ 139.59	5
	up to 0.64m <sup>2</sup>	VF6100xHxW	\$ 177.61	5
	up to 0.81m <sup>2</sup>	VF7100xHxW	\$ 192.46	5
	up to 1.00m <sup>2</sup>	VF8100xHxW	\$ 218.30	5
	up to 1.21m <sup>2</sup>	VF9100xHxW	\$ 247.10	5
	up to 1.44m <sup>2</sup>	VF10100xHxW	\$ 276.80	5

50mm Flat Panel Filters F4	Area m2	Code	\$/each	Qty Pkt
	up to 0.09m <sup>2</sup>	FP150xHxW	\$ 96.00	5
	up to 0.16m <sup>2</sup>	FP250xHxW	\$ 156.00	5
	up to 0.25m <sup>2</sup>	FP350xHxW	\$ 70.74	5
	up to 0.36m <sup>2</sup>	FP450xHxW	\$ 75.06	5
	up to 0.49m <sup>2</sup>	FP550xHxW	\$ 105.30	5
	up to 0.64m <sup>2</sup>	FP650xHxW	\$ 110.43	5
	up to 0.81m <sup>2</sup>	FP750xHxW	\$ 116.10	5
	up to 1.00m <sup>2</sup>	FP850xHxW	\$ 123.39	5
	up to 1.21m <sup>2</sup>	FP950xHxW	\$ 129.06	5
	up to 1.44m <sup>2</sup>	FP1050xHxW	\$ 136.35	5

25mm Flat Panel Filters F4	Area m2	Code	\$/each	Qty Pkt
	up to 0.09m <sup>2</sup>	FP125xHxW	\$ 52.11	5
	up to 0.16m <sup>2</sup>	FP225xHxW	\$ 59.67	5
	up to 0.25m <sup>2</sup>	FP325xHxW	\$ 59.75	5
	up to 0.36m <sup>2</sup>	FP425xHxW	\$ 66.00	5
	up to 0.49m <sup>2</sup>	FP525xHxW	\$ 88.29	5
	up to 0.64m <sup>2</sup>	FP625xHxW	\$ 92.88	5
	up to 0.81m <sup>2</sup>	FP725xHxW	\$ 98.01	5
	up to 1.00m <sup>2</sup>	FP825xHxW	\$ 116.37	5
	up to 1.21m <sup>2</sup>	FP925xHxW	\$ 122.58	5
	up to 1.44m <sup>2</sup>	FP1025xHxW	\$ 129.33	5

Ph: 02 9525 0970

Fax: 02 9540 2899

Email: orders@arrowsales.com.au



# Copper Pipe & Fittings

## COPPER PIPE FOR A/C AND REFRIGERATION

Pre-Insulated Paired Coil		Size						Wt Per Piece (kg)	Pick Up \$/each
Code	Dimensions	OD (mm)	WT (mm)	L (M)	OD (mm)	WT (mm)	L (M)		
CUC1438PC	Cu Pair Coil(6.35x0.81+9.52x0.81)x20M	6.35	0.81	20	9.52	0.81	20	6.41	\$ 266.01
CUC1412PC	Cu Pair Coil(6.35x0.81+12.7x0.81)x20M	6.35	0.81	20	12.70	0.81	20	7.84	\$ 316.69
CUC1458PC	Cu Pair Coil(6.36x0.81+15.88x1.02)x20M	6.35	0.81	20	15.88	1.02	20	10.85	\$ 439.83
CUC3858PC	Cu Pair Coil(9.52x0.81+15.88x1.02)x20M	9.52	0.81	20	15.88	1.02	20	12.27	\$ 487.33
CUC3834PC	Cu Pair Coil(9.52x0.81+19.05x1.14)x20M	9.52	0.81	20	19.05	1.14	20	15.38	\$ 596.29
CUC1234PC	Cu Pair Coil(12.7x0.81+19.05x1.14)x20M	12.70	0.81	20	19.05	1.14	20	16.81	\$ 535.60
R410A Rated	Yes - all items								
Type	AN - all items								



Pancake Copper Coils		R410A Rated	Type	Size			Wt Per Piece (kg)	Pick Up \$/each
Code	Dimensions			OD (mm)	WT (mm)	L (M)		
CUC1421P30	Cu Pancake (6.35x0.81)x30M	Yes	AN	6.35	0.81	30	5.36	\$ 151.78
CUC3821P	Cu Pancake (9.52x0.81)x18M	Yes	AN	9.52	0.81	18	3.57	\$ 153.14
CUC1221P	Cu Pancake (12.7x0.81)x18M	Yes	AN	12.70	0.81	18	4.87	\$ 219.72
CUC5819P	Cu Pancake (15.88x1.02)x18M	Yes	AN	15.88	1.02	18	7.66	\$ 307.61
CUC3420P	Cu Pancake (19.05x0.91)x18M		AN	19.05	0.91	18	8.34	\$ 265.35
CUC3419P	Cu Pancake (19.05x1.14)x18M	Yes	AN	19.05	1.14	18	10.30	\$ 423.53
CUC7820P	Cu Pancake (22.23x0.91)x18M		AN	22.23	0.91	18	9.81	\$ 328.38
CUC7817P	Cu Pancake (22.23x1.40)x18m	Yes	AN	22.23	1.40	18	17.00	\$ 666.96





## FIRE RATE

### COPPER PIPE FOR A/C AND REFRIGERATION

Pre-Insulated Paired Coil		Size						Wt Per Piece (kg)	Pick Up \$/each
Code	Dimensions	OD (mm)	WT (mm)	L (M)	OD (mm)	WT (mm)	L (M)		
CUCFR1438K	1/4 x 3/8 13mm Fire Rated Pair Coil 20m	6.35	0.81	20	9.52	0.81	20	9.10	\$ 335.96
CUCFR1412K	1/4 x 1/2 13mm Fire Rated Pair Coil 20m	6.35	0.81	20	12.70	0.81	20	11.50	\$ 397.34
CUCFR1458K	1/4 x 5/8 13mm Fire Rated Pair Coil 20m	6.35	0.81	20	15.88	1.02	20	13.95	\$ 488.38
CUCFR3858K	3/8 x 5/8 13mm Fire Rated Pair Coil 20m	9.52	0.81	20	15.88	1.02	20	15.60	\$ 587.17
CUCFR3834K	3/8 x 3/4 13mm Fire Rated Pair Coil 20m	9.52	0.81	20	19.05	1.14	20	19.30	\$ 720.46
R410A Rated	Yes - all items								
Type	AN - all items								

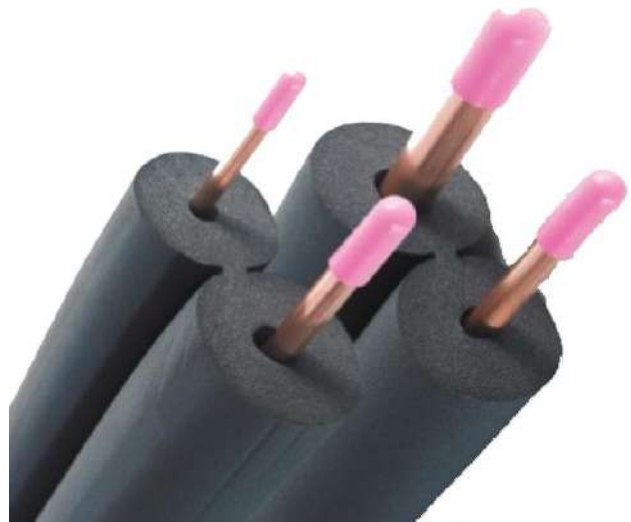

Pre-Insulated Paired Coil		Size						Wt Per Piece (kg)	Pick Up \$/each
Code	Dimensions	OD (mm)	WT (mm)	L (M)	OD (mm)	WT (mm)	L (M)		
CUCFR19K1438	1/4 x 3/8 FR 19mm Wall Pair Coil 18m	6.35	0.81	18	9.52	0.81	18	10.30	\$ 429.89
CUCFR19K1412	1/4 x 1/2 FR 19mm Wall Pair Coil 18m	6.35	0.81	18	12.70	0.81	18	11.75	\$ 479.02
CUCFR19K1458	1/4 x 5/8 FR 19mm Wall Pair Coil 18m	6.35	0.81	18	15.88	1.02	18	14.50	\$ 580.92
CUCFR19K3858	3/8 x 5/8 FR 19mm Wall Pair Coil 18m	9.52	0.81	18	15.88	1.02	18	15.88	\$ 658.99
CUCFR25W1458	1/4 x 5/8 FR 25mm Wall Pair Coil 12m	6.35	0.81	18	15.88	1.02	18		\$ 625.06
CUCFR25W3858	3/8 x 5/8 FR 25mm Wall Pair Coil 15m	9.52	0.81	18	15.88	1.02	18.00		\$ 601.46
CUCFR25W3834	3/8 x 3/4 FR 25mm Wall Pair Coil 12m	9.52	0.81	20	19.05	1.14	18.00		\$ 625.06
R410A Rated	Yes - all items								
Type	AN - all items								

Ph: 02 9525 0970

Fax: 02 9540 2899

Email: orders@arrowsales.com.au

Please Note All Prices Are GST Exclusive

## COPPER PIPE FOR A/C AND REFRIGERATION

Drawn Lengths		R410A Rated	Type	Size			Wt Per Piece (kg)	Pick Up \$/each
Code	Dimensions			OD (mm)	WT (mm)	L (M)		
CUSAC0621	Cu AC Length (6.35x0.81)x6M	Yes	HD	6.35	0.81	6	0.76	\$29.71
CUSAC1021	Cu AC Length (9.52x0.81)x6M	Yes	HD	9.52	0.91	6	1.19	\$46.73
CUSAC1221H	Cu AC Length (12.7x0.81)x6M	Yes	HH	12.70	0.91	6	1.62	\$63.29
CUSAC1621H	Cu AC Length (15.88x0.81)x6M		HH	15.88	0.91	6	2.06	\$78.84
CUSAC1619H	Cu AC Length (15.88x1.02)x6M	Yes	HH	15.88	1.02	6	2.55	\$99.58
CUSAC2020H	Cu AC Length (19.05x0.91)x6M		HH	19.05	0.91	6	2.78	\$117.88
CUSAC2019H	Cu AC Length (19.05x1.14)x6M	Yes	HH	19.05	1.14	6	3.44	\$134.16
CUSAC2220	Cu AC Length (22.23x0.91)x6M		HD	22.23	0.91	6	3.27	\$138.45
CUSAC2217	Cu AC Length (22.23x1.40)x6M	Yes	HD	22.23	1.63	6	4.91	\$190.70
CUSAC2520	Cu AC Length (25.4x0.91)x6M		HD	25.40	0.91	6	3.75	\$184.70
CUSAC2516	Cu AC Length (25.4x1.63)x6M	Yes	HD	25.40	1.63	6	6.53	\$252.24
CUSAC2820	Cu AC Length (28.58x0.91)x6M		HD	28.58	0.91	6	4.24	\$179.58
CUSAC2814	Cu AC Length (28.58x1.83)x6M	Yes	HD	28.58	1.83	6	8.25	\$318.65
CUSAC3220	Cu AC Length (31.75x0.91)x6M		HD	31.75	0.91	6	4.73	\$157.20
CUSAC3212	Cu AC Length (31.75x2.03)x6M	Yes	HD	31.75	2.03	6	10.16	\$428.06
CUSAC3520	Cu AC Length (34.9x0.91)x6M		HD	34.90	0.91	6	5.21	\$166.74
CUSAC3512	Cu AC Length (34.9x2.03)x6M	Yes	HD	34.90	2.03	6	11.24	\$436.78
CUSAC3820	Cu AC Length (38.1x0.91)x6M		HD	38.10	0.91	6	5.70	\$192.06
CUSAC3814	Cu AC Length (38.1x2.29)x6M	Yes	HD	38.10	2.29	6	13.82	\$626.16
CUSAC4220	Cu AC Length (41.28x0.91)x6M		HD	41.28	0.91	6	6.19	\$211.25
CUSAC4213	Cu AC Length (41.28x2.41)x6M	Yes	HD	41.28	2.41	6	15.78	\$612.65
CUSAC5018	Cu AC Length (50.8x1.22)x6M		HD	50.80	1.22	6	10.19	POA
CUSAC5420	Cu AC Length (54.0x0.91)x6M		HD	54.00	0.91	6	8.14	\$417.23
CUSAC5418	Cu AC Length (54.0x1.22)x6M		HD	54.00	1.22	6	10.85	\$525.90
CUSAC5818	Cu AC Length (66.7x1.22)x6M		HD	66.70	1.22	6	13.46	\$629.45

Code	9mm Continous Coil Insulation	\$ Box
TSSC9INS14	6 mm Continous Coil 9mm - 70m	\$142.22
TSSC9INS38	10 mm Continous Coil 9mm - 50m	\$117.33
TSSC9INS12	12 mm Continous Coil 9mm - 45m	\$122.05
TSSC9INS58	15 mm Continous Coil 9mm - 40m	\$119.90
TSSC9INS1	25 mm Continous Coil 9mm - 26m	\$103.76



Code	13mm Continous Coil Insulation	\$ Box
TSSC13INS14	6 mm Continous Coil 13mm - 45m	\$106.59
TSSC13INS38	10 mm Continous Coil 13mm - 35m	\$93.14
TSSC13INS12	12 mm Continous Coil 13mm - 32m	\$97.92
TSSC13INS58	15 mm Continous Coil 13mm - 32m	\$107.08
TSSC13INS1	25 mm Continous Coil 13mm - 20m	\$94.14

Ph: 02 9525 0970

Fax: 02 9540 2899

Email: orders@arrowsales.com.au

## HVAC COPPER

Code	Description	\$/each
CUFE14D90	1/4 90 Degree Elbow R410A	\$ 2.43
CUFE38D90	3/8 90 Degree Elbow R410A	\$ 2.13
CUFE12D90	1/2 90 Degree Elbow R410A	\$ 1.71
CUFE58D90	5/8 90 Degree Elbow R410A	\$ 2.40
CUFE34D90	3/4 90 Degree Elbow R410A	\$ 4.80
CUFE78D90	7/8 90 Degree Elbow R410A	\$ 5.88
CUFE10D90	1 90 Degree Elbow R410A	\$ 8.40
CUFE114D90	1 1/4 90 Degree Elbow R410	\$ 23.82
CUFE118D90	1 1/8 90 Degree Elbow R410A	\$ 14.40
CUFE138D90	1 3/8 90 Degree Elbow R410A	\$ 25.20
CUFE158D90	1 5/8 90 Degree Elbow R410A	\$ 44.76



Code	Description	\$/each
CUFE38D45	3/8 45 Degree Elbow R410A	\$ 3.54
CUFE12D45	1/2 45 Degree Elbow R410A	\$ 5.16
CUFE58D45	5/8 45 Degree Elbow R410A	\$ 2.43
CUFE34D45	3/4 45 Degree Elbow R410A	\$ 9.27
CUFE78D45	7/8 45 Degree Elbow R410A	\$ 4.80
CUFE10D45	1 45 Degree Elbow R410A	\$ 13.08
CUFE118D45	1 1/8 45 Degree Elbow R410A	\$ 21.06
CUFE138D45	1 3/8 45 Degree Elbow R410A	\$ 25.71
CUFE158D45	1 5/8 45 Degree Elbow R410A	\$ 44.64



Code	Description	\$/each
CUFC14	1/4 Coupling R410A	\$ 0.86
CUFC38	3/8 Coupling R410A	\$ 1.04
CUFC12	1/2 Coupling R410A	\$ 1.75
CUFC58	5/8 Coupling R410A	\$ 1.56
CUFC34	3/4 Coupling R410A	\$ 2.98
CUFC78	7/8 Coupling R410A	\$ 3.20
CUFC10	1 Coupling R410A	\$ 4.50
CUFC118	1 1/8 Coupling R410A	\$ 8.61
CUFC138	1 3/8 Coupling R410A	\$ 17.22
CUFC158	1 5/8 Coupling R410A	\$ 20.49



## FIRE RATED INSULATION

The Building Code of Australia (2005) provides a fire specification for fire testing of materials: Specification A2.4 (Fire Hazard Properties). This requires that materials are tested under the standard AS/NZS 1530.3, and meet stringent requirements for indices of both Spread-of-Flame and Smoke-Developed.



### Pipe Insulation 9mm Wall

Code	Description	mm	\$/Length	Box Qty
TINS14	6mm FR Pipe Insulation 9mm - 2m	6	\$ 2.50	105
TINS38	10mm FR Pipe Insulation 9mm - 2m	10	\$ 2.94	84
TINS12	12mm FR Pipe Insulation 9mm - 2m	12	\$ 3.82	60
TINS58	15mm FR Pipe Insulation 9mm - 2m	15	\$ 4.19	50
TINS34	20mm FR Pipe Insulation 9mm - 2m	20	\$ 4.58	44
TINS78	22mm FR Pipe Insulation 9mm - 2m	22	\$ 5.43	40
TINS1	25mm FR Pipe Insulation 9mm - 2m	25	POA	35
TINS118	28mm FR Pipe Insulation 9mm - 2m	28	\$ 7.64	28
TINS114	32mm FR Pipe Insulation 9mm - 2m	32	\$ 7.90	25
TINS138	35mm FR Pipe Insulation 9mm - 2m	35	\$ 8.32	45
TINS112	40mm FR Pipe Insulation 9mm - 2m	40	\$ 10.37	40
TINS158	42mm FR Pipe Insulation 9mm - 2m	42	\$ 11.00	36
TINS2	50mm FR Pipe Insulation 9mm - 2m	50	POA	25
TINS218	54mm FR Pipe Insulation 9mm - 2m	54	\$ 14.01	25
TINS238	60mm FR Pipe Insulation 9mm - 2m	60	\$ 16.43	20
TINS258	67mm FR Pipe Insulation 9mm - 2m	67	POA	20
TINS3	76mm FR Pipe Insulation 9mm - 2m	76	\$ 7.54	16
TINS318	80mm FR Pipe Insulation 9mm - 2m	80	POA	18



### Pipe Insulation 13mm Wall

Code	Description	mm	\$/Length	Box Qty
TFR13INS14	6mm FR Pipe Insulation 13mm - 2m	6	\$ 5.76	50
TFR13INS38	10mm FR Pipe Insulation 13mm - 2m	10	\$ 5.52	50
TFR13INS12	12mm FR Pipe Insulation 13mm - 2m	12	\$ 6.06	40
TFR13INS58	15mm FR Pipe Insulation 13mm - 2m	15	\$ 6.90	36
TFR13INS34	20mm FR Pipe Insulation 13mm - 2m	20	\$ 9.15	32
TFR13INS78	22mm FR Pipe Insulation 13mm - 2m	22	\$ 8.94	28
TFR13INS1	25mm FR Pipe Insulation 13mm - 2m	25	\$ 11.25	23
TFR13INS118	28mm FR Pipe Insulation 13mm - 2m	28	\$ 11.06	43
TFR13INS114	32mm FR Pipe Insulation 13mm - 2m	32	\$ 15.99	35
TFR13INS138	35mm FR Pipe Insulation 13mm - 2m	35	\$ 16.20	33
TFR13INS112	40mm FR Pipe Insulation 13mm - 2m	40	\$ 19.35	30
TFR13INS158	42mm FR Pipe Insulation 13mm - 2m	42	\$ 19.44	24
TFR13INS2	50mm FR Pipe Insulation 13mm - 2m	50	\$ 22.50	20
TFR13INS218	54mm FR Pipe Insulation 13mm - 2m	54	\$ 25.29	20
TFR13INS238	60mm FR Pipe Insulation 13mm - 2m	60	\$ 29.28	16
TFR13INS258	67mm FR Pipe Insulation 13mm - 2m	67	\$ 33.90	15
TFR13INS3	76mm FR Pipe Insulation 13mm - 2m	76	\$ 40.47	11
TFR13INS318	80mm FR Pipe Insulation 13mm - 2m	80	\$ 30.92	9
TFR13INS312	89mm FR Pipe Insulation 13mm - 2m	83	\$ 33.49	9
TFR13INS378	101mm FR Pipe Insulation 13mm - 2m	101	\$ 37.71	8
TFR13INS412	114mm FR Pipe Insulation 13mm - 2m	114	\$ 48.06	6





## FIRE RATED INSULATION

The Building Code of Australia (2005) provides a fire specification for fire testing of materials: Specification A2.4 (Fire Hazard Properties). This requires that materials are tested under the standard AS/NZS 1530.3, and meet stringent requirements for indices of both Spread-of-Flame and Smoke-Developed.



### Pipe Insulation 19mm Wall

Code	Description	mm	\$/Length	Box Qty
TFRINS38	10mm FR Pipe Insulation 19mm - 2m	10	\$ 10.50	50
TFRINS12	12mm FR Pipe Insulation 19mm - 2m	12	\$ 11.34	42
TFRINS58	15mm FR Pipe Insulation 19mm - 2m	15	\$ 15.21	36
TFRINS34	20mm FR Pipe Insulation 19mm - 2m	20	\$ 15.18	36
TFRINS78	22mm FR Pipe Insulation 19mm - 2m	22	\$ 18.09	36
TFRINS1	25mm FR Pipe Insulation 19mm - 2m	25	\$ 20.73	30
TFRINS118	28mm FR Pipe Insulation 19mm - 2m	28	\$ 22.71	25
TFRINS114	32mm FR Pipe Insulation 19mm - 2m	32	\$ 26.85	20
TFRINS138	35mm FR Pipe Insulation 19mm - 2m	35	\$ 27.27	20
TFRINS112	40mm FR Pipe Insulation 19mm - 2m	40	\$ 38.28	18
TFRINS158	42mm FR Pipe Insulation 19mm - 2m	42	\$ 33.15	16
TFRINS2	50mm FR Pipe Insulation 19mm - 2m	50	\$ 36.90	16
TFRINS218	54mm FR Pipe Insulation 19mm - 2m	54	\$ 40.05	12
TFRINS238	60mm FR Pipe Insulation 19mm - 2m	60	\$ 57.42	9
TFRINS258	67mm FR Pipe Insulation 19mm - 2m	67	\$ 53.04	9
TFRINS3	76mm FR Pipe Insulation 19mm - 2m	76	\$ 68.94	8
TFRINS318	80mm FR Pipe Insulation 19mm - 2m	80	\$ 70.14	7
TFRINS312	89mm FR Pipe Insulation 19mm - 2m	89	\$ 50.17	7
TFRINS378	101mm FR Pipe Insulation 19mm - 2m	101	\$ 51.50	6
TFRINS412	114mm FR Pipe Insulation 19mm - 2m	114	\$ 58.54	6



### Pipe Insulation 25mm Wall

Code	Description	mm	\$/Length	Box Qty
TFR25INS14	6mm FR Pipe Insulation 25mm - 2m	6	\$ 15.66	
TFR25INS38	10mm FR Pipe Insulation 25mm - 2m	10	\$ 15.51	40
TFR25INS12	12mm FR Pipe Insulation 25mm - 2m	12	\$ 20.49	30
TFR25INS58	15mm FR Pipe Insulation 25mm - 2m	15	\$ 20.88	30
TFR25INS34	20mm FR Pipe Insulation 25mm - 2m	20	\$ 24.09	26
TFR25INS78	22mm FR Pipe Insulation 25mm - 2m	22	\$ 26.37	20
TFR25INS1	25mm FR Pipe Insulation 25mm - 2m	25	\$ 30.21	20
TFR25INS118	28mm FR Pipe Insulation 25mm - 2m	28	\$ 27.69	16
TFR25INS114	32mm FR Pipe Insulation 25mm - 2m	32	\$ 38.13	16
TFR25INS138	35mm FR Pipe Insulation 25mm - 2m	35	\$ 38.22	16
TFR25INS112	40mm FR Pipe Insulation 25mm - 2m	40	\$ 59.31	15
TFR25INS158	42mm FR Pipe Insulation 25mm - 2m	42	\$ 43.44	12
TFR25INS2	50mm FR Pipe Insulation 25mm - 2m	50	\$ 57.12	9
TFR25INS218	54mm FR Pipe Insulation 25mm - 2m	54	\$ 54.81	9
TFR25INS238	60mm FR Pipe Insulation 25mm - 2m	60	\$ 74.10	9
TFR25INS258	67mm FR Pipe Insulation 25mm - 2m	67	\$ 71.31	8
TFR25INS3	76mm FR Pipe Insulation 25mm - 2m	76	\$ 100.74	5
TFR25INS318	80mm FR Pipe Insulation 25mm - 2m	25	\$ 72.66	5
TFR25INS312	89mm FR Pipe Insulation 25mm - 2m	8	\$ 104.61	4
TFR25INS378	101mm FR Pipe Insulation 25mm - 2m	27	\$ 88.58	4
TFR25INS412	114mm FR Pipe Insulation 25mm - 2m	29	\$ 98.02	4

Ph: 02 9525 0970

Fax: 02 9540 2899

Email: orders@arrowsales.com.au

## Armaflex® Solar UT

Armaflex® Solar UT is a highly flexible closed-cell pipe insulation for solar-water systems. Specifically designed and tested for the flow and return lines of solar hot water systems. Armaflex® Solar UT is ideal for high temperature applications (up to 150° C) and long-term outdoor exposure.



Armaflex® Solar UT 2m Tubes					
Product Code	Internal Diameter	Thickness	Tubes/ Carton	\$/Length	\$/m
TSOLH1512	12mm (1/2")	15 mm	32	\$ 18.90	\$ 9.45
TSOLH1520	20 mm (3/4")	15 mm	20	\$ 19.98	\$ 9.99

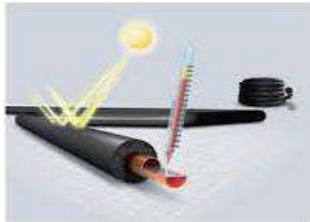

Armaflex® Solar UT Continuous Tubes					
Product Code	Internal Diameter	Thickness	Coil Length	\$/ Carton	\$/Length
TSOLCIS12	12mm (1/2")	15 mm	25 m	\$ 251.03	\$ 10.04
TSOLCIS20	20 mm (3/4")	15 mm	20 m	\$ 150.00	\$ 7.50



Armaflex® Solar UT Accessories					
Product Code	Description	\$/Roll	Length	Qty	
TSOLCTP	Armaflex® Solar UT Tape	\$4.01	\$ 12.00	1	

Self Seal

### Also Available:

Pipe Ferrules



Flat Insulation Sheets in 9,



## Plumbing Copper

Copper Pancake Coil		Pack	Type	Size			Weight/ Piece (kg)	Pick Up \$/each
Code	Dimensions	Qty		OD (mm)	Wt (mm)	L (mm)		
CUPP1220	Cu Pancake (12.7x0.91)x18M DN15B-AN	4	AN	12.70	0.91	18	5.42	\$ 238.01
CUPP1220L	Cu Pancake (12.7x0.91)x18M DN15B-AN	1	AN-LAG	12.70	0.91	18	5.42	\$ 267.41
CUPP2019	Cu Pancake (19.05x1.02)x18M DN20B-AN	2	AN	19.05	1.02	18	9.30	\$ 407.97
CUPP2019L	Cu Pancake (19.05x1.02)x18M DN20B-AN	1	AN-LAG	19.05	1.02	18	9.30	\$ 449.33

TYPE B PLUMBING COPPER		Pack	Type	Size			Weight/ Piece (kg)	Pick Up \$/each
Code	Dimensions	Qty		OD (mm)	Wt (mm)	L (mm)		
CUSP1220	Cu Length (12.7x0.91)x6M DN15B-BQ	150	BQ	12.70	0.91	6	1.81	\$ 78.65
CUSP1220L	Cu Length (12.7x0.91)x6M DN15B-BQ	10	BQ-LAG	12.70	0.91	6	1.81	\$ 88.07
CUSP2020	Cu Length (19.05x0.91)x6M DN20C-BQ	50	BQ	19.05	0.91	6	2.80	\$ 137.67
CUSP2019	Cu Length (19.05x1.02)x6M DN20B-BQ	100	BQ	19.05	1.02	6	3.10	\$ 136.30
CUSP2019L	Cu Length (19.05x1.02)x6M DN20B-BQ	10	BQ-LAG	19.05	1.02	6	3.10	\$ 148.10
CUSP2518	Cu Length (25.4x1.22)x6M DN25B-HD	60	HD	25.40	1.22	6	4.97	\$ 219.92
CUSP3218	Cu Length (31.75x1.22)x6M DN32B-HD	50	HD	31.75	1.22	6	6.28	\$ 277.64
CUSP3818	Cu Length (38.1x1.22)x6M DN40B-HD	40	HD	38.10	1.22	6	7.58	\$ 336.85
CUSP5018	Cu Length (50.8x1.22)x6M DN50B-HD	30	HD	50.80	1.22	6	10.19	\$ 449.20
CUSP6518	Cu Length (63.5x1.22)x6M DN65B-HD	25	HD	63.50	1.22	6	12.80	\$ 566.70
CUSP8016	Cu Length (76.2x1.63)x6M DN80B-HD	15	HD	76.20	1.63	6	20.48	\$ 918.70
CUSP10016	Cu Length (101.6x1.63)x6M DN100B-HD	10	HD	101.60	1.63	6	27.45	\$ 1,230.90
CUSP12516	Cu Length (127.0x1.63)x6M DN125B-HD	8	HD	127.00	1.63	6	34.43	\$ 1,546.91
CUSP15014	Cu Length (152.4x2.03)x6M DN150B-HD	3	HD	152.40	2.03	6	51.43	\$ 2,378.24
CUSP20014	Cu Length (203.20x2.03)x6M DN200B-HD		HD	203.20	2.03	6	68.80	\$ 3,323.75

## Plumbing Copper

Code	Description	\$/each
CUFE15D90	Cu Fitting DN15x90 S/R P/B	\$ 1.08
CUFE20D90	Cu Fitting DN20x90 S/R P/B	\$ 2.25
CUFE25D90	Cu Fitting DN25x90 S/R P/B	\$ 4.65
CUFE32D90	Cu Fitting DN32x90 S/R P/B	\$ 9.54
CUFE40D90	Cu Fitting DN40x90 S/R P/B	\$ 12.36
CUFE50D90	Cu Fitting DN50x90 S/R P/B	\$ 23.94
CUFE65D90	Cu Fitting DN65x90 S/R P/B	\$ 37.56
CUFE80D90	Cu Fitting DN80x90 S/R P/B	\$ 61.89
CUFE100D90	Cu Fitting DN100x90 S/R P/B	\$ 116.19
CUFE25D45	Cu Fitting DN25x45 S/R P/B	\$ 7.02
CUFE32D45	Cu Fitting DN32x45 S/R P/B	\$ 4.80
CUFE40D45	Cu Fitting DN40x45 S/R P/B	\$ 6.00
CUFE50D45	Cu Fitting DN50x45 S/R P/B	\$ 15.33
CUFE65D45	Cu Fitting DN65x45 S/R P/B	\$ 27.81
CUFE80D45	Cu Fitting DN80x45 S/R P/B	\$ 47.07
CUFE100D45	Cu Fitting DN100x45 S/R P/B	\$ 88.23

### Couplings

CUFC15	Cu Fitting DN15 Cu Coupling	\$ 0.93
CUFC20	Cu Fitting DN20 Cu Coupling	\$ 2.16
CUFC25	Cu Fitting DN25 Cu Coupling	\$ 3.00
CUFC32	Cu Fitting DN32 Cu Coupling	\$ 4.50
CUFC40	Cu Fitting DN40 Cu Coupling	\$ 6.00
CUFC50	Cu Fitting DN50 Cu Coupling	\$ 8.10
CUFC65	Cu Fitting DN65 Cu Coupling	\$ 15.90
CUFC80	Cu Fitting DN80 Cu Coupling	\$ 26.01
CUFC100	Cu Fitting DN100 Cu Coupling	\$ 33.00

### F+F (W1R) Reducers

CUFRC2015	Cu Fitting DN20xDN15 PR Reducer	\$ 1.50
CUFRC2520	Cu Fitting DN25xDN20 PR Reducer	\$ 3.15

### Silver Solder

CUSS2P	2% Yellow Tip Silver Solder - p/kg	\$ 103.32
CUSS5P	5% Silver Tip Silver Solder - p/kg	\$ 196.80
CUSS15P	15% Brown Tip Silver Solder - p/kg	\$ 455.11
CUSS45P	45% Silver Solder - p/stick	\$ 16.80

Code	Description	\$/each
CUFT15E	Cu Fitting DN15 Equal Tee	\$ 2.34
CUFT20E	Cu Fitting DN20 Equal Tee	\$ 6.09
CUFT25E	Cu Fitting DN25 Equal Tee	\$ 14.49
CUFT32E	Cu Fitting DN32 Equal Tee	\$ 9.60
CUFT40E	Cu Fitting DN40 Equal Tee	\$ 19.89
CUFT50E	Cu Fitting DN50 Equal Tee	\$ 32.61
CUFT65E	Cu Fitting DN65 Equal Tee	\$ 31.50
CUFT80E	Cu Fitting DN80 Equal Tee	\$ 54.00
CUFT100E	Cu Fitting DN100 Equal Tee	\$ 139.11
CUFTR202015	Cu Fitting Tee Reduce W25 20x20x15C	\$ 3.30
CUFTR252515	Cu Fitting Tee Reduce W25 25x25x15C	\$ 8.55
CUFTR252520	Cu Fitting Tee Reduce W25 25x25x20C	\$ 8.55
CUFTR201520	Cu Fitting Tee Reduce W26 20x20Cx15E	\$ 4.05
CUFTR251525	Cu Fitting Tee Reduce W26 25x25Cx15E	\$ 7.95
CUFTR252025	Cu Fitting Tee Reduce W26 25x25Cx20E	\$ 3.30
CUFTR201515	Cu Fitting Tee Reduce W27 20x15Cx15E	\$ 8.10
CUFTR252020	Cu Fitting Tee Reduce W27 25x20Cx20E	\$ 3.30

### M&F Concentric Reducers

CUFR2015	Cu Fitting DN20X15 PR Reducers	\$ 1.29
CUFR2520	Cu Fitting DN25X20 PR Reducers	\$ 4.56
CUFR3220	Cu Fitting DN32X20 PR Reducers	\$ 5.58
CUFR3225	Cu Fitting DN32X25 PR Reducers	\$ 4.50
CUFR4020	Cu Fitting DN40X20 PR Reducers	\$ 7.17
CUFR4025	Cu Fitting DN40X25 PR Reducers	\$ 7.11
CUFR4032	Cu Fitting DN40X32 PR Reducers	\$ 6.33
CUFR5025	Cu Fitting DN50X25 PR Reducers	\$ 5.55
CUFR5032	Cu Fitting DN50X32 PR Reducers	\$ 5.55
CUFR5040	Cu Fitting DN50X40 PR Reducers	\$ 9.93
CUFR6540	Cu Fitting DN65X40 PR Reducers	\$ 8.70
CUFR6550	Cu Fitting DN65X50 PR Reducers	\$ 8.70
CUFR8050	Cu Fitting DN80X50 PR Reducers	\$ 15.15
CUFR8065	Cu Fitting DN80X65 PR Reducers	\$ 15.15
CUFR10050	Cu Fitting DN100X50 PR Reducers	\$ 21.00
CUFR10065	Cu Fitting DN100X65 PR Reducers	\$ 21.00



**Air  
Conditioning  
&  
Refrigeration  
Drain Systems**

Ph: 02 9525 0970

Fax: 02 9540 2899

Email: [orders@arrowsales.com.au](mailto:orders@arrowsales.com.au)

Please Note All Prices Are GST Exclusive





## PRESSURE PIPE DRAINAGE SYSTEM

Air Conditioning & Refrigeration Drain Pipe	Nom. Size	Code	Pipe Length	Pick Up \$/each	Qty	Bulk \$/each	Qty
	15	PD15ACR	4m	\$ 13.31	Each	\$ 11.98	40
	20	PD20ACR	4m	\$ 17.88	Each	\$ 16.09	40
	25	PD25ACR	4m	\$ 24.83	Each	\$ 22.35	20
	32	PD32ACR	4m	\$ 29.70	Each	\$ 23.35	10

Reducer Bushing (Slip x Slip) Cat. No. 5	Nom. Size	Code	Pick Up \$/each	Qty	Bulk \$/each	Qty
	20 x 15	SRB0750	\$ 0.95	300	\$ 0.83	50
	25 x 15	SRB1005	\$ 1.82	300	\$ 1.39	50
	25 x 20	SRB1007	\$ 1.82	300	\$ 1.39	50
	32 x 20	SRB1207	\$ 2.08	150	\$ 1.73	50
	32 x 25	SRB1210	\$ 2.36	150	\$ 1.98	50
	250 x 200	SRB10080	\$ 509.07		\$ 424.22	

Coupling (Slip x Slip) Cat. No. 7	Nom. Size	Code	Pick Up \$/each	Qty	Bulk \$/each	Qty
	15	SCS05	\$ 0.65	300	\$ 0.45	50
	20	SCS07	\$ 0.74	300	\$ 0.54	50
	25	SCS10	\$ 1.25	300	\$ 0.99	50
	32	SCS12	\$ 1.72	150	\$ 1.61	50
	250	SCS100	\$ 596.95		\$ 537.26	

Reducer Bushing (Slip x Slip) Cat. No. 8	Nom. Size	Code	Pick Up \$/each	Qty	Bulk \$/each	Qty
	20 x 15	SRS0750	\$ 1.10	300	\$ 0.95	50
	25 x 15	SRS1005	\$ 1.69	300	\$ 1.53	50
	25 x 20	SRS1007	\$ 1.82	300	\$ 1.53	50
	32 x 20	SRS1207	\$ 2.46	150	\$ 2.14	50
	32 x 25	SRS1210	\$ 2.48	150	\$ 2.14	50

45 Degree Elbow (Slip x Slip) Cat. No. 10	Nom. Size	Code	Pick Up \$/each	Qty	Bulk \$/each	Qty
	15	SAS05	\$ 1.25	300	\$ 0.85	50
	20	SAS07	\$ 1.81	300	\$ 1.13	50
	25	SAS10	\$ 2.35	150	\$ 1.48	50
	32	SAS12	\$ 3.90	150	\$ 2.68	50

90 Degree Elbow (Slip x Slip) Cat. No. 13	Nom. Size	Code	Pick Up \$/each	Qty	Bulk \$/each	Qty
	15	SLS05	\$ 0.80	50	\$ 0.61	50
	20	SLS07	\$ 0.90	50	\$ 0.68	50
	25	SLS10	\$ 1.62	50	\$ 1.14	50
	32	SLS12	\$ 2.78	50	\$ 2.34	50

Ph: 02 9525 0970

Fax: 02 9540 2899

Email: orders@arrowsales.com.au

## PRESSURE PIPE DRAINAGE SYSTEM

Valve Socket (Male Adpt)   Cat No.7								
	Nom.	Size	Code	Pick Up \$/each	Qty	Bulk \$/each	Qty	
		15		SMT05	\$ 0.96	300	\$ 0.63	50
		20		SMT07	\$ 1.02	300	\$ 0.78	50
		25		SMT10	\$ 1.82	150	\$ 1.15	50

P Trap								
	Nom.	Size	Code	Pick Up \$/each	Qty	Bulk \$/each	Qty	
		20		EACT20	\$ 26.74	20	\$ 22.40	20
		25		EACT25	\$ 6.08	10	\$ 5.63	10

20mm Clear Jtrap Tube							
	Nom.	Size	Code	Pick Up \$/each	Qty	Bulk \$/each	Qty
		20		JTRAP	\$ 18.00	1	\$ 15.00

Faucet Socket (Female Adpt)   Cat No.18								
	Nom.	Size	Code	Pick Up \$/each	Qty	Bulk \$/each	Qty	
		15		SFT05	\$ 0.91	300	\$ 0.87	50
		20		SFT07	\$ 1.29	300	\$ 1.05	50
		25		SFT10	\$ 1.69	150	\$ 1.30	50

Tee (Slip & Slip)   Cat No.19								
	Nom.	Size	Code	Pick Up \$/each	Qty	Bulk \$/each	Qty	
		15		STS05	\$ 1.19	300	\$ 1.09	50
		20		STS07	\$ 1.19	300	\$ 1.05	50
		25		STS10	\$ 2.01	150	\$ 1.77	50
		20x25		STS1007	\$ 3.07	150	\$ 2.56	50
		32		STS12	\$ 3.56	150	\$ 2.84	50

## CONDUIT DRAINAGE SYSTEM

Conduit Pipe								
	Nom.	Size	Code	Pick Up \$/each	Qty	Bulk \$/each	Qty	
		16		ERC16	\$ 10.32	10	\$ 9.29	40
		20		ERC20	\$ 7.84	10	\$ 7.52	40
		25		ERC25	\$ 13.58	10	\$ 12.64	20
		32		ERC32	\$ 20.29	5	\$ 18.26	10
		40		ERC40	\$ 29.97	5	\$ 26.97	10
		50		ERC50	\$ 44.62		\$ 40.16	

## CONDUIT DRAINAGE SYSTEM

Couplings Grey						
	Nom. Size	Code	Pick Up \$/each	Qty	Bulk \$/each	Qty
	16	ETC16	\$ 0.15	50	\$ 0.15	50
	20	ETC20	\$ 0.41	20	\$ 0.32	20
	25	ETC25	\$ 0.47	20	\$ 0.36	20
	32	ETC32	\$ 0.79	20	\$ 0.61	20

Step Reducer						
	Nom. Size	Code	Pick Up \$/each	Qty	Bulk \$/each	Qty
	16 x 20	ERD2016	\$ 0.27	20	\$ 0.23	20
	25 x 20	ERD2520	\$ 0.32	20	\$ 0.27	20
	32 x 25	ERD3225	\$ 1.50	20	\$ 1.22	20

SWEEP BEND TELSTRA						
	Nom. Size	Code	Pick Up \$/each	Qty	Bulk \$/each	Qty
		20	ESB20TELSTRA	\$ 4.27		\$ -

90 Degree Elbow						
	Nom. Size	Code	Pick Up \$/each	Qty	Bulk \$/each	Qty
	16	EEL16	\$ 0.45	20	\$ 0.45	20
	20	EEL20	\$ 0.68	20	\$ 0.56	20
	25	EEL25	\$ 0.95	20	\$ 0.79	20
	32	EEL32	\$ 1.65	20	\$ 1.65	20

Straight Tee						
	Nom. Size	Code	Pick Up \$/each	Qty	Bulk \$/each	Qty
	16	EST16	\$ 0.45	20	\$ 0.45	20
	20	EST20	\$ 0.79	20	\$ 0.61	20
	25	EST25	\$ 1.35	20	\$ 1.35	20
	32	EST32	\$ 1.65	20	\$ 1.65	20

Flexible Hose						
	Nom. Size	Code	Pick Up \$/each	Qty	Bulk \$/each	Qty
	16 x 50	HOSERF16	\$ 81.00	50	\$ 81.00	50
	18 x 50	HOSERF18	\$ 96.00	50	\$ -	50
	16 x 30	HOSERFS16	\$ 84.00	50	\$ 70.00	50



Rigid Telstra Conduit						
	Nom. Size	Code	Pick Up \$/each	Qty	Bulk \$/each	Qty
		20	ERC20TEL	\$ 7.78		\$ -

Ph: 02 9525 0970

Fax: 02 9540 2899

Email: orders@arrowsales.com.au

Please Note All Prices Are GST Exclusive

PVC Solvent Cement				
	Code	Description	\$/each	Qty Pkt
 	SOL100	Clear Solvent - 100g	\$ 5.83	1
	SOL500	Clear Solvent - 500g	\$ 18.68	1
	SOLB500	Type N PVC Blue Solvent -500ml	\$ 18.68	1
	SOLG500	Green Solvent - 500g	\$ 14.79	1
	SOLP500	Pink Priming Fluid - 500g	\$ 10.98	1
	SOLT1L	Insulation Adhesive - 1L	\$ 66.99	1
	SOLT500	Insulation Glue - 520 Adhesive 500ml	\$ 46.77	1
	SOL250	Type N PVC Clear Solvent - 250ml	\$ 12.77	1
	SOLB250	Type N PVC Blue Solvent - 250ml	\$ 14.04	1
	SOLG250	Green Solvent Type P - 250g	\$ 10.89	1
	SOLGN500	Clear PVC Glue Type P - 500ml	\$ 32.65	1
	SOLP250	Red Priming Fluid - 250g	\$ 9.19	1
	SOLPC500	PVC Clear Priming Fluid - 500ml	\$ 10.98	1

Red Cap				
	Code	Description	\$/each	Qty Pkt
	REDCAP	20mm RedCap	\$ 7.50	1
	REDCAP25	25mm RedCap	\$ 5.60	1

EZ-Trap Transparent Cross Trap				
	Code	Description	\$/each	Qty Pkt
	EZT113	Ez-Trap Trans Cross Trap	\$ 38.94	1



EZ-Trap Smart Trap With Float Switch				
	Code	Description	\$/each	Qty Pkt
	EZT210	Ez-Trap Smart Trap With Float Switch	\$ 140.64	1



EZ-Trap Cut Off Switches				
	Code	Description	\$/each	Qty Pkt
	EZT224	Close Couple Float Switch 20mm	\$ 98.76	1
	EZT225	Vertical/Horizontal Float Switch	\$ 98.76	1
	EZT226	Close Couple Float Switch 25mm	\$ 89.76	1

Brush				
	Code	Description	\$/each	Qty Pkt
	EZT113B	EZ-TRAP with Brush	\$ 46.32	1
	EZT406	Flexible Brush	\$ 12.00	1

Ph: 02 9525 0970

Fax: 02 9540 2899

Email: orders@arrowsales.com.au

Please Note All Prices Are GST Exclusive

Clear and Re-inforced PVC Hose				
	Code	Description	\$/each	Per Mtr
	HOSECL06	6mm Clear Flexible PVC Hose	\$ 2.29	Mtr
	HOSECL08	8mm Clear Flexible PVC Hose	\$ 2.86	Mtr
	HOSECL10	10mm Clear Flexible PVC Hose	\$ 3.09	Mtr
	HOSECL13	13mm Clear Flexible PVC Hose	\$ 4.63	Mtr
	HOSECL19	16mm Clear Flexible PVC Hose	\$ 6.18	Mtr
	HOSECL20	19mm Clear Flexible PVC Hose	\$ 8.32	Mtr
	HOSECL25	25mm Clear Flexible PVC Hose	\$ 13.53	Mtr
	HOSECL32	32mm Clear Flexible PVC Hose	\$ 18.69	Mtr
	HOSECL38	38mm Clear Flexible PVC Hose	\$ 23.37	Mtr
	HOSER10	10mm Re-Inforced Clear Flex Hose	\$ 7.33	Mtr
	HOSER20	20mm Re-Inforced Clear Flex Hose	\$ 16.10	Mtr
	HOSER25	25mm Re-Inforced Clear Flex Hose	\$ 23.61	Mtr

Hose Clamps   Zinc Plated				
	Code	Description	\$/each	Qty - Pkt
	HOSEC12	15-20mm Galvanised Hose Clamp	\$ 2.54	10
	HOSEC18	18-25mm Galvanised Hose Clamp	\$ 2.57	10
	HOSEC20	22-32mm Galvanised Hose Clamp	\$ 2.76	10
	HOSEC30	27-40mm Galvanised Hose Clamp	\$ 2.82	10
	HOSEC40	40-55mm Galvanised Hose Clamp	\$ 3.26	10
	HOSEC50	55-70mm Galvanised Hose Clamp	\$ 3.50	10
	HOSEC120	120-155mm Galvanised Hose Clamp	\$ 5.67	10
	HOSEC9216	216mm Galvanised Hose Clamps	\$ 20.25	10

Hose Clamps   Stainless Steel				
	Code	Description	\$/each	Qty - Pkt
	HOSEC120S	120-155mm Stainless Steel Hose Clamp	\$ 8.37	

Condensate Pumps				
	Code	Description	\$/each	Qty - Pkt
	PUMPCMAX	Maxi Orange Condensate Pump	\$ 389.70	1
	PUMPCMOR	Mini Orange Condensate Pump	\$ 338.64	1
	PUMPAQUA	Mini Aqua Condensate Pump	\$ 338.64	1
	PUMPCLIMES	Mini Lime Silent Condensate Pump	\$ 474.66	1
	PUMPCMB	Mini Blanc Condensate Pump	\$ 338.64	1
	PUMPBMIC	Blue Diamond Micro Blue Pump w Res	\$ 375.00	1
	PUMPBMIN	Blue Diamond Mini Blue Pump w Res	\$ 474.00	1



Tank Pumps Hi-Flow Aspen				
	Code	Description	\$/each	Qty Pkt
	PUMPHFO	MAX Hi Flow Tank Pump	\$ 288.54	1
	PUMPBMAX	Blue Diamond Maxi Blue Pump w Res	\$ 474.00	1
	PUMPBMEG	Blue Diamond Mega Blue Pump w Res	\$ 540.00	1

MAPP Gas Tools				
	Code	Description	\$/each	Qty Pkt
	TOOLMAPGAS	Mapp Gass	\$ 22.95	1
	TOOLMPV471XP	Vulcane Express Complete Set	\$ 524.77	1





Spring Flashings   Dektites				
	Code	Description	\$/each	Qty Pkt
	FLASH660	Flashing 6-60mm 120mm Base	\$ 10.80	1
	FLASH5080	Flashing 50-80mm 160mm Base	\$ 16.80	1
	FLASH60110	Flashing 6-110mm 195mm Base	\$ 25.20	1

## CONSUMABLES

Christmass Tress Plugs				
	Code	Description	\$/each	Qty - Pkt
	ACHRIST	Christmas Tree Plugs - 6mm	\$ 0.39	100
	ACHRIST8	Christmas Tree Plugs - 8mm	\$ 0.27	100

Mounting Base   Self Adhesive				
	Code	Description	\$/each	Qty - Pkt
	CTIEB13N	Mounting Base - Self Adhesive	\$ 0.32	100
	CTIEB19B	Mounting Base - Self Adhesive	\$ 0.25	100
	CTIEB19N	Mounting Base - Self Adhesive	\$ 0.28	100
	CTIEB28B	Mounting Base - Self Adhesive	\$ 0.44	100
	CTIEB28N	Mounting Base - Self Adhesive	\$ 0.43	100
	CTIEB38N	Mounting Base - Self Adhesive	\$ 0.94	100

Blue Hanging Strap				
	Code	Description	\$/each	Qty - Pkt
	FS	Blue 25mm x 50m Hanging Strap	POA	1

Perforated Steel Strapping				
	Code	Description	\$/each	Qty - Pkt
	FS415M	Flexi-Strapping 23 x .04 x 15m (30kg)	\$ 19.17	1
	FS715M	Flexi-Strapping 23 x .07 x 15m (60kg)	\$ 30.88	1
	FS715S	Flexi-Strapping S/Steel 25 x 0.7 x 15m	\$ 226.00	1

Pair Coil Hanger For Threaded Rod				
	Code	Description	\$/each	Qty -Pkt
	PRBMH2	Metal Pair Coil 3/8 - 5/8	\$ 8.82	10
	PRBPH2	Plastic Pair Coil Hanger 3/8 - 5/8	\$ 8.04	10

Duct Tape   Nopi Brand				
	Code	Description	\$/each	Qty - Pkt
	DUCTG	Grey Duct Tape - 48mm x 3m	\$ 5.10	60
	DUCTB	Black Duct Tape - 48mm x 3m	\$ 5.10	60

## CONSUMABLES

Roof And Gutter Silicone				
	Code	Description	\$/each	Qty - Pkt
	SILTRANS	Translucent 300g	\$ 15.46	20
	SILGREY	Grey 300g	\$ 15.46	20
	SILBLK	Black 300g	\$ 15.46	20

Bathroom Silicon				
	Code	Description	\$/each	Qty - Pkt
	SILSAN	White 300g	\$ 15.46	20
	SANT	Translucent 300g	\$ 15.46	20





Glass And Window Silicon				
	Code	Description	\$/each	Qty - Pkt
	SILWBL	White 300g	\$ 15.46	20
	SILWTR	Black 300g	\$ 15.46	20

Gap Filler				
	Code	Description	\$/each	Qty - Pkt
	GAPFIL	White - 475g	\$ 6.65	20

Construction Adhesive   320g				
	Code	Description	\$/each	Qty - Pkt
	NNAIL	Never Nail	\$ 7.26	20

Silver Foil Tape				
	Code	Description	\$/each	Qty - Pkt
	FOIL48	Foil Tape 48mm	\$ 26.95	1
	FOIL72	Foil Tape 72mm	\$ 36.00	1

## CONSUMABLES

Cable Ties				
	Code	Description	\$/100	Qty - Pkt
	CTIE100B	Cable Tie Black 100 x 2.5mm	\$ 5.81	100
	CTIE100BN	Cable Tie Natural 100 x 2.5mm Bulk	\$ 1.25	100
	CTIE100N	Cable Tie Natural 100 x 2.5mm	\$ 1.76	100
	CTIE150B	Cable Tie Black 150 x 3.5mm	\$ 4.59	100
	CTIE900B	Cable Tie Black 900mm	\$ 104.09	100
	CTIE800B	Cable Tie Black 800mm	\$ 91.00	100
	CTIE540B	Cable Tie Black 540x7.6mm	\$ 53.87	100
	CTIE1220B	Cable Tie Black 1220x9.0mm	\$ 133.65	100
	CTIE150N	Cable Tie Natural 150 x 3.5mm	\$ 4.59	100
	CTIE200B	Cable Tie Black 200 x 4.7mm	\$ 6.15	100
	CTIE200N	Cable Tie Natural 200 x 4.7mm	\$ 6.15	100
	CTIE300B	Cable Tie Black 301 x 4.8mm	\$ 10.94	100
	CTIE300N	Cable Tie Natural 301 x 4.8mm	\$ 10.94	100
	CTIE370B	Cable Tie Black 370x4.8mm	\$ 15.05	100
	CTIE380B	Cable Tie Black 382 x 7.5mm	\$ 26.78	100
CTIE380N	Cable Tie Natural 382 x 7.5mm	\$ 21.76	100	
CTIE383N	Cable Tie Nature 383 x 4.8mm	\$ 16.41	100	
	Code	Description	\$/each	Qty - Pkt
	CTIE150BULK	Cable Tie Black 150x3.5mm	\$ 25.38	1000
	CTIE200BN	Cable Tie Natural 200x4.7mm Bulk	\$ 59.40	1000
	CTIE200BULK	Cable Tie Black 200x4.7mm	\$ 47.49	1000
	CTIE300B500	Cable Tie Black 301x4.8mm	\$ 38.00	500
	CTIE300BULK	Cable Tie Black 301x4.8mm	\$ 91.80	1000
	CTIE150BN	Cable Tie Black 150 x 3.5mm Bulk	\$ 36.45	1000
Continous Tie				
	Code	Description	\$/100	Qty - Pkt
	CTIECNT	Continuous Tie - 16m	POA	1
	CTIEB19B	Mounting Base - Self Adhesive - (100 Pack)	\$ 24.84	100
Duct Ties				
	Code	Description	\$/100	Qty - Pkt
	CTIE535N	Duct Cable Tie 535 x 8.8mm	\$ 45.60	25
	CTIE820N	Duct Cable Tie 820 x 8.8mm	\$ 99.93	25
	CTIE925N	Duct Cable Tie 925 x 8.8mm	\$ 105.42	25
	CTIE820W	Duct Cable Tie 820 x 8.8mm Wres	\$ 96.82	25
	CTIE1100N	Duct Cable Tie 1095 x 8.9mm	\$ 159.12	25
	CTIE1300W	Duct Cable Ties 1325 x 8.9 Wres	\$ 180.57	25
	CTIE1220N	Duct Tie 1220x9mm	\$ 140.00	100
	CTIE1550N	Duct Ties 1550x9mm (18inch)	\$ 372.09	100
CTIE535W	Duct Cable Tie 535x8.8mm WRes	\$ 126.81	100	
Cable Tie Weather				
	Code	Description	\$/each	Qty - Pkt
	CTIE100W	Cable Tie Weather Res 100x2.5mm	\$ 1.46	
	CTIE200BW	Cable Tie Weather Res. 200x4.7mm Bulk	\$ 5.87	
	CTIE200W	Cable Tie Weather Res. 200x4.7mm	\$ 5.91	

Ph: 02 9525 0970

Fax: 02 9540 2899

Email: orders@arrowsales.com.au

Please Note All Prices Are GST Exclusive

## CONSUMABLES

AC Bases				
	Code	Description	\$/each	Qty Pkt
 <b>Ezyslab</b>	POLYSBL	Polyslab - Large - 1130 x 650mm	\$ 88.20	1
	POLYSBM	Polyslab - Medium - 465 x 885mm	\$ 46.76	1
	POLYSBS	Polyslab - Small - 339 x 639mm	\$ 32.13	1
	POLYEZY	Ezyslab Black 930 x 480 x 50mm	\$ 46.92	1
	POLYMZ24	Black Walkway Matrix - 400x1200mm	\$ 88.20	



Waffle Pad Strips an Squares				
	Code	Description	\$/each	Qty
	WAEP1000100	Waffle Pad 1000x100x10	\$ 18.44	1
	WAEP5050	50x50mm WAFFLE SQUARE + 13mm HOLE	\$ 1.98	1
	WAEPFM45458	450x450 Waffle Pad	\$ 23.75	1
	WAEP2525	25mm Waffle washers 6mm hole	\$ 1.08	1
	WAEPFM4545FS	Shearflex 450x450 Red Waffle Pad	\$ 70.00	1

450mm PVC Mounting Block				
	Code	Description	\$/each	Qty
	PDMBIV	450mm PVC Mounting Block	\$ 23.04	1

Adjustable And Standard Feet				
	Code	Description	\$/Set	Qty
	FRF400A	Adjustable Rubber Feet (Set of 4)	\$ 26.13	1
	FRFSTD	Rubber Condensor Stand (Pack of 4)	\$ 21.80	1

Hot Dipped Galvanised Cantilever Brackets				
	Code	Description	\$/Each	Qty
	CA0300	300mm Un-Braced Cantilever Brkt HDG	\$ 20.66	2
	CA0450	450mm Un-Braced Cantilever Brkt HDG	\$ 25.66	2
	CA0600	600mm Un-Braced Cantilever Brkt HDG	\$ 31.24	2
	CAB320	320mm BRACED CANTILEVER BRKT	\$ 29.34	2
	CAB470	470mm BRACED CANTILEVER BRKT HDG	\$ 33.38	2
	CAB635	635mm BRACED CANTILEVER BRKT HDG	\$ 42.12	2
	CAB780	780mm BRACED CANTILEVER BRKT	\$ 44.64	2
	CABB900	900mm Back-on-Back Cantilever Brkt	\$ 111.13	2
	CABASS1	CANTILEVER ASSEMBLY KIT NO RUBBER	\$ 10.38	1
	CABASS2	CANTILEVER ASSEMBLY KIT WITH RUBBER	\$ 19.90	1

Ph: 02 9525 0970

Fax: 02 9540 2899

Email: orders@arrowsales.com.au

Please Note All Prices Are GST Exclusive



## CONSUMABLES

Studding Clip   M10				
	Code	Description	\$/each	Qty Pkt
	PRPS038	10mm M10 Studding Clip	\$ 3.24	10
	PRPS012	12mm M10 Studding Clip	\$ 3.24	10
	PRPS058	15mm STUDDING (M10) CLIP	\$ 3.30	10
	PRPS034	20mm STUDDING (M10) CLIP	\$ 3.48	10
	PRPS078	22mm STUDDING (M10) CLIP	\$ 3.48	10
	PRPS1	25mm STUDDING (M10) CLIP	\$ 3.48	10
	PRPS112	38mm STUDDING (M10) CLIP	\$ 4.14	10
	PRPS114	32mm STUDDING (M10) CLIP	\$ 3.84	10
	PRPS118	28mm STUDDING (M10) CLIP	\$ 3.60	10
	PRPS138	35mm STUDDING (M10) CLIP	\$ 3.96	10
	PRPS158	42mm STUDDING (M10) CLIP	\$ 4.38	10
	PRPS2	51mm M10 Studding Clip	\$ 4.98	10
	PRPS218	54mm M10 Studding Clip	\$ 5.28	10

Rapid Positioning Insul Clip				
	Code	Description	\$/each	Qty
	PRPI034	20mm (3/4) Rapid Pos Insul Clip	\$ 4.68	10
	PRPI058	15mm (5/8) Rapid Pos Insul Clip	\$ 4.38	10
	PRPI078	22mm (7/8) Rapid Pos Insul Clip	\$ 5.10	10
	PRPI1	25mm (1) Rapid Pos Insul Clip	\$ 5.46	10
	PRPI112	38mm (1 1/2) Rapid Pos Insul Clip	\$ 7.62	10
	PRPI114	32mm (1 1/4) Rapid Pos Insul Clip	\$ 6.18	10
	PRPI118	28mm (1 1/8) Rapid Pos Insul Clip	\$ 5.82	10
	PRPI138	35mm (1 3/8) Rapid Pos Insul Clip	\$ 6.90	10
	PRPI158	42mm (1 5/8) Rapid Pos Insul Clip	\$ 8.28	10
	PRPI2	51mm (2) Rapid Pos Insul Clip	\$ 9.42	10

## CONSUMABLES

Rubber Lined Channel Clips				
	Code	Description	\$/each	Qty
	CHR010	9.5mm (3/8) RUBBER LINED CL	\$ 5.28	
	CHR012	12.7mm (1/2) RUBBER LINED CL	\$ 5.28	
	CHR016	15.8mm (5/8) RUBBER LINED CL	\$ 5.40	
	CHR020	19mm (3/4) RUBBER LINED CL	\$ 5.58	
	CHR022	22mm (7/8) RUBBER LINED CL	\$ 5.82	
	CHR025	25mm (1) RUBBER LINED CL	\$ 5.64	
	CHR028	28mm (1 1/8) RUBBER LINED CL	\$ 6.06	
	CHR032	32mm (1 1/4) RUBBER LINED CL	\$ 6.48	
	CHR035	35mm (1 3/8) RUBBER LINED CL	\$ 6.66	
	CHR038	38mm (1 1/2) RUBBER LINED CL	\$ 7.92	
	CHR041	41mm (1 5/8) RUBBER LINED CL	\$ 8.16	
	CHR050	50mm (2) RUBBER LINED CL	\$ 8.71	
	CHR060	60mm (2 1/2) RUBBER LINED CL	\$ 16.56	
	CHR075	76mm (3) RUBBER LINED CL	\$ 19.26	
	CHR090	88mm (3 1/2) RUBBER LINED CL	\$ 19.50	
	CHR110	108-114.3mm RUBBER LINED CL	\$ 24.24	
CHR125	125-138.9mm RUBBER LINED CL	\$ 28.70		
CHR150	159-165.2mm RUBBER LINED CL	\$ 33.71		



Quick Positioning Hangers   M10				
	Code	Description	\$/each	Qty
	PRQPH1118	Quick Pos Hanger 1 - 1 1/8 PIPE O/D	\$ 4.21	10

Wall And Roof Mount Brackets				
	Code	Description	\$/each	Qty
	CAS450	Wall Bracket P/C Steel 180kg 450mm Arm	\$ 37.80	1
	CAS450S	460mm S/Steel Bracket with Cross Bar	\$ 102.30	1
	CAS550	Wall Bracket P/C Steel 250kg 550mm Arm	\$ 69.99	1
	CAR150	560mm P/Coated Roof Bracket	POA	1
	CAR150S	Roof Bracket 150kg S/Steel	POA	1



## Electrical Products

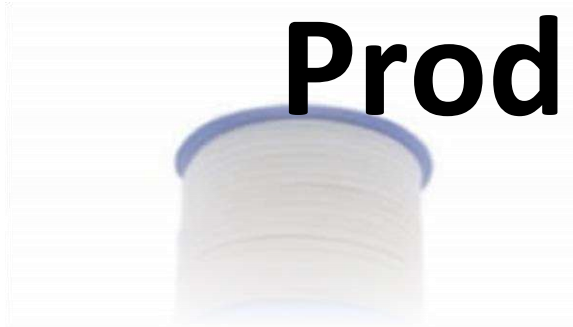

## Electrical Products

Cable Ducting	Code	Dimensions	Pick Up \$/each	Qty - Pkt
	ECD1610	16mm x 10mm x 4Mtr	\$ 32.45	Each
	ECD1616	16mm x 16mm x 4Mtr	\$ 34.90	Each
	ECD2010	20mm x 10mm x 4Mtr	\$ 14.25	Each
	ECD2516	25mm x 16mm x 4Mtr	\$ 37.65	Each
	ECD2525	25mm x 25mm x 4Mtr	\$ 53.13	Each
	ECD4020	40mm x 20mm x 4Mtr	\$ 21.00	Each
	ECD5025	50mm x 25mm x 4Mtr	\$ 100.88	Each
	ECD5050	50mm x 50mm x 4Mtr	\$ 133.63	Each
	ECD7550	75mm x 50mm x 4Mtr	\$ 277.27	Each
	ECD7575	75mm x 75mm x 4Mtr	\$ 98.80	Each
	ECD10050	100mm x 50mm x 4Mtr	\$ 318.22	Each
	ECD10080	100mm x 80mm x 4Mtr	\$ 114.00	Each
	ECD100100	100mm x 100mm x 4Mtr	\$ 414.47	Each
	ECD15075	150mm x 75mm x 4Mtr	\$ 165.00	Each

SLOTTED CABLE DUCT			PickUp	Qty
	Code:	Dimensions	\$/each	Pkt
	ECDS4060	40W x 60 c/w Cap	\$ 32.52	
	ECDS6060	60W x 60 c/w Cap	\$ 31.65	

CORRUGATED CONDUIT GREY			PickUp	Qty
	Code:	Dimensions	\$/each	Pkt
	ECC2020	20mm x 20mt Roll	\$ 82.29	EACH
	ECC2025	20mm x 25mt Roll	\$ 36.00	EACH
	ECC2525	25mm x 25mt Roll	\$ 54.00	EACH
	ECC3210	32mm x 10mt Roll	\$ 105.97	EACH
	ECC4010	40mm x 10mt Roll	\$ 209.06	EACH
	ECC5010	50mm x 10mt Roll	\$ 259.93	EACH
	ECC2520	25mm x 20mt Roll	\$ 109.25	EACH
	ECC2550	25mm x 50mt Roll	\$ 102.00	EACH
	ECC3225	32mm x 25mt Roll	\$ 108.00	EACH

CORRUGATED CONDUIT GREY			PickUp	Qty
	Code:	Dimensions	\$/each	Pkt
	ECCO2025	20mm x 25mt Roll	\$ 36.00	EACH
	ECCO2525	25mm x 25mt Roll	\$ 60.00	EACH

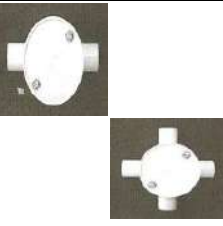
SHALLOW JUNCTION BOX 20mm ENTRY			PickUp	Qty
	Code:	Dimensions	\$/each	Pkt
	EJB1-20	20mm One Way	\$ 2.30	10
	EJN2-20	20mm Two Way	\$ 1.80	10
	EJB3-20	20mm Three Way	\$ 2.30	10
	EJB4-20	20mm Four Way	\$ 1.80	10
	EJB5-20	20mm Five Way	\$ 1.80	10

Ph: 02 9525 0970

Fax: 02 9540 2899

Email: orders@arrowsales.com.au

Please Note All Prices Are GST Exclusive

## Electrical Products

ADAPTABLE SQUARE BOXES			PickUp	Qty
	Code:	Dimensions	\$/each	Pkt
	EAB332	75mmx75mmx50mm	\$ 13.50	5
	EAB333	75mmx75mmx75mm	\$ 12.00	5
	EAB442	100mmx100mmx50mm	\$ 13.50	10
	EAB443	100mmx100mmx75mm	\$ 14.55	10
	EAB662	150mmx150mmx50mm	\$ 27.75	10
	EAB663	150mmx150mmx75mm	\$ 30.75	10
	EAB664	150mmx150mmx100mm	\$ 37.50	10

Plain to Adaptor Connector	Code	Dimensions	Pick Up \$/each	Qty - Pkt
	EPS20	20mm Plain to Adaptor	\$ 0.79	50
	EPS25	25mm Plain to Adaptor	\$ 1.20	50
	EPS32	32mm Plain to Adaptor	\$ 2.25	50
	EPS40	40mm Plain to Adaptor	\$ 2.85	50

PLAIN TO SCREWED			PickUp	Qty
	Code:	Dimensions	\$/each	Pkt
	EPSM32	32mm Male Adaptor - Plain to Screwed	\$ 3.92	

PLAIN TO CORRUGATED CONNECTOR			PickUp	Qty
	Code:	Dimensions	\$/each	Pkt
	ECSCP20	20mm Plain to Corrugated	\$ 1.05	50
	ECSCP25	25mm Plain to Corrugated	\$ 1.65	50
	ECSCP20TELSTRA	20mm TELSTRA PLAIN TO CONDUIT	\$ 6.75	50

CORRUGATED TO ADAPTOR CONNECTOR			PickUp	Qty
	Code:	Dimensions	\$/each	Pkt
	EC SCT20	20mm Corrugated to Screw	\$ 1.85	50
	EC SCT25	25mm Corrugated to Screw	\$ 2.50	50

RIGHT ANGLED CORRUGATED ADAPTOR			PickUp	Qty
	Code:	Dimensions	\$/each	Pkt
	ECA20-90	20mm Adaptor 90 deg	\$ 1.84	50
	ECA25-90	25mm Adaptor 90 deg	\$ 1.95	50

CORRUGATED GLANDS			PickUp	Qty
	Code:	Dimensions	\$/each	Pkt
	ECCG16	16mm Corrugated Glands	\$ 1.35	100
	ECCG20	20mm Corrugated Glands	\$ 1.50	100
	ECCG25	25mm Corrugated Glands	\$ 1.80	100
	ECCG32	32mm Corrugated Glands	\$ 4.50	100



## Electrical Products

BLACK CABLES GLANDS IP68			PickUp	Qty
	Code:	Dimensions	\$/each	Pkt
	ECG12	12mm Black Cable Glands IP68	\$ 1.32	
	ECG16	16mm Black Cable Glands IP68	\$ 0.95	
	ECG20	20mm Black Cable Gland IP68	\$ 1.42	
	ECG25	25mm Black Cable Gland IP68	\$ 1.89	
	ECG32	32mm Black Cable Glands IP68	\$ 2.99	
	ECG40	40mm Black Cable Gland IP68	\$ 7.18	
	ECG50	50mm Black Cable Gland	\$ 9.10	

CONDUIT PLUG			PickUp	Qty
	Code:	Dimensions	\$/each	Pkt
	ECP20	20mm Grey Plug	\$ 0.12	50
	ECP25	25mm Grey Plug	\$ 0.24	50

CEILING JUNCTION BOXES			PickUp	Qty
	Code:	Dimensions	\$/each	Pkt
	ECJB	Single Screw Connectors With 3 x 6mm - Small	\$ 3.75	10
	ECJB3W	Junction box with 3 way terminal - Small	\$ 3.00	
	ECJBL	Junction Boxes - Large	\$ 5.10	

DEEP JUNCTION BOX			PickUp	Qty
	Code:	Dimensions	\$/each	Pkt
	EDJB1-20	20mm One Way	\$ 2.30	
	EDJB2-20	20mm Two Way	\$ 2.30	
	EDJB2-25	25mm Two Way	\$ 2.70	
	EDJB3-25	25mm Three Way	\$ 2.70	
	EDJB4-25	25mm Four Way	\$ 2.70	

## SWITCHES



GANG SWITCH		PickUp	Qty
Code:	Dimensions	\$/each	Pkt
ESG1GSW	1 Gang Switch (Standard / Small)	\$ 6.60	1
ESG2GSW	2 Gang Switch (Standard / Small)	\$ 10.20	1
ESG2GSWA	2 GANG LIVING + BED SWITCH	\$ 19.00	
ESG2GSWE	2 GANG SWITCH (EMPTY)	\$ 4.20	
ESG2GSWZ	2 GANG ZONE 1+2 SWITCH	\$ 19.00	
ESG3GSW	3 Gang Switch (Standard / Small)	\$ 15.00	1
ESG3GSWA	3 GANG LIVING + BED + BED SWITCH	\$ 35.10	
ESG3GSWE	3 GANG SWITCH (EMPTY)	\$ 4.20	
ESG4GSWE	4 GANG SWITCH (EMPTY)	\$ 4.80	
ESG4GSW	4 Gang Switch (Standard / Small)	\$ 18.00	1
ESG5GSWE	5 GANG SWITCH (EMPTY)	\$ 4.80	
ESG6GSWE	6 GANG SWITCH (EMPTY)	\$ 4.80	



CONNECTOR		PickUp	Qty
Code:	Dimensions	\$/each	Pkt
ESGCS1	Connector - 1 Screw	\$ 29.40	1
ESGCS2	Connector - 2 Screw Jar-50	\$ 28.35	



POWER POINT		PickUp	Qty
Code:	Dimensions	\$/each	Pkt
ESGSP	Single Power Point	\$ 9.99	1
ESGDPP	Double Power Point	\$ 11.40	1
ESGSLDPP	Double Power Point - Slim Line	\$ 12.69	



ENCLOSURE		PickUp	Qty
Code:	Dimensions	\$/each	Pkt
ESGEN1P	Enclosure 1 Pole	\$ 6.75	1
ESGEN2P	Enclosure 2 Pole	\$ 8.10	1
ESGEN3P	Enclosure 3 Pole	\$ 10.50	1



MCB SINGLE POLE		PickUp	Qty
Code:	Dimensions	\$/each	Pkt
ESGMCB45-16	MCB Single Pole - 4.5KA 16amp	\$ 7.56	1
ESGMCB6-10	MCB Single Pole - 6KA 10amp	\$ 8.00	1
ESGMCB6-16	MCB Single Pole - 6KA 16amp	\$ 8.00	1
ESGMCB6-20	MDB Single Pole - 6KA 20amp	\$ 8.00	1
ESGMCB6-25	MDB Single Pole - 6KA 25amp	\$ 8.00	1
ESGMCB6-32	MCB Single Pole - 6KA 32amp	\$ 8.00	1

MCB TRIPLE POLE		PickUp	Qty
Code:	Dimensions	\$/each	Pkt
ESGMCB36-100	MCB Triple Pole - 6KA - 100A	\$ 21.60	
ESGMCB36-20	MCB Triple Pole - 6KA - 20A	\$ 21.60	
ESGMCB36-32	MCB Triple Pole - 6KA - 32A	\$ 21.60	
ESGMCB36-40	MCB Triple Pole - 6KA - 40A	\$ 21.60	
ESGMCB3P-25A	MCB 3 Triple Pole - 6KA - 25amp	\$ 50.00	

Ph: 02 9525 0970

Fax: 02 9540 2899

Email: orders@arrowsales.com.au

Please Note All Prices Are GST Exclusive

## SWITCHES

ZONE 1 SWITCH		PickUp	Qty
Code:	Dimensions	\$/each	Pkt
ESG1GZB	ZONE 1 Switch Mechanism 16A	\$ 5.30	
ESG1GZF	ZONE 2 Switch Mechanism 16A	\$ 14.55	
ESG1GZL	ZONE 3 Switch Mechanism 16A	\$ 5.30	

		PickUp	Qty
Code:	Dimensions	\$/each	Pkt
ESG1GZ1	BED Switch Mechanism 16A	\$ 5.30	
ESG1GZ2	Fan Switch Mechanism 10A	\$ 5.30	
ESG1GZ3	LIVING Switch Mechanism 16A	\$ 5.30	

POWER POINT		PickUp	Qty
Code:	Dimensions	\$/each	Pkt
ESGSPP15A	15A POWER POINT	\$ 9.00	

POWER POINT		PickUp	Qty
Code:	Dimensions	\$/each	Pkt
ESGDPPSW	Double GPO + Switch	\$ 18.76	

WEATHERPROOF POWER POINT		PickUp	Qty
Code:	Dimensions	\$/each	Pkt
ESGWPG01	WeatherProof Single Power Point	\$ 34.02	1
ESGWPG02	WeatherProof Double Power Point	\$ 41.70	1



WEATHERPROOF SWITCH		PickUp	Qty
Code:	Dimensions	\$/each	Pkt
ESGWPS-120	WeatherProof Switch 1P 20A	\$ 30.00	1
ESGWPS-320	WeatherProof Isolator 3P 20A	POA	1
ESGWPS1-32	WeatherProof Isolator 1P 32A	\$ 30.00	1
ESGWPS1-63	WeatherProof Isolator 1P 63A	\$ 30.00	1
ESGWPS3-32	WeatherProof Isolator 3P 32A	\$ 60.30	1
ESGWPS3-63	WeatherProof Isolator 3P 63A	\$ 67.50	1



BLACK STRIP CONNECTOR		PickUp	Qty
Code:	Dimensions	\$/each	Pkt
ESGSTR1010	10amp 10mm Black Strip Connector	\$ 4.95	

SURFACE SOCKET		PickUp	Qty
Code:	Dimensions	\$/each	Pkt
ESGSSS	Single Surface Socket	\$ 4.80	1



WEATHERPROOF SWITCH		PickUp	Qty
Code:	Dimensions	\$/each	Pkt
ESGWSW1	WeatherProof Single Switch	\$ 29.28	1
ESGWSW2	WeatherProof Double Switch	\$ 37.20	1



## SWITCHES

GANG BLANK PLATE		PickUp	Qty
Code:	Dimensions	\$/each	Pkt
ESGGC	GANG BLANK PLATE ONLY	\$ 3.75	

Industrial Comb Switched Socket		PickUp	Qty
Code:	Dimensions	\$/each	Pkt
ESGICV315	Industrial Comb Switched Socket 15A 3P	\$ 85.60	
ESGICV420	Industrial Comb Switched Socket 20A 4P	\$ 80.70	
ESGICV520	Industrial Comb Switched Socket 20A 5P	\$ 110.50	

Industrial StraitPlug		PickUp	Qty
Code:	Dimensions	\$/each	Pkt
ESGIP520	Industrial StraitPlug 20A 5P	\$ 69.78	

Industrial Pendant Socket		PickUp	Qty
Code:	Dimensions	\$/each	Pkt
ESGISC420	Industrial Pendant Socket 20A 4P	\$ 63.77	

Industrial Waterproof Socket		PickUp	Qty
Code:	Dimensions	\$/each	Pkt
ESGISO420	Industrial Waterproof Socket 20A 4P	\$ 57.05	
ESGISO520	Industrial Waterproof Socket 20A 5P	\$ 63.77	
ESGISW120	Industrial Waterproof Switch 20A 1P	\$ 61.85	

MOUNTING BLOCK		PickUp	Qty
Code:	Dimensions	\$/each	Pkt
ESGMB	MOUNTING BLOCK - STANDARD	\$ 3.90	

Single Combined		PickUp	Qty
Code:	Dimensions	\$/each	Pkt
ESGRMC1-16	Single Combined 4.5kA RCBO 16A	\$ 40.00	
ESGRMC1-20	Single Combined 4.5kA RCBO 20A	\$ 40.00	
ESGRMC1-25	Single Combined 4.5kA RCBO 25A	\$ 45.00	
ESGRMC1-32	Single Combined 4.5kA RCBO 32A	\$ 45.00	
ESGRMC1A-16	Single Combined 6.5kA RCBO 16A	\$ 50.70	
ESGRMC1A-20	Single Combined 6.5kA RCBO 20A	\$ 50.70	

Double Combined Circ Breaker		PickUp	Qty
Code:	Dimensions	\$/each	Pkt
ESGRMC2-10	Double Combined Circ Breaker RCD 2P10A	\$ 40.00	
ESGRMC2-16	Double Combined Circ Breaker RCD 2P16A	\$ 40.00	
ESGRMC2-20	Double Combined Circ Breaker RCD 2P20A	\$ 44.00	

Slim Line		PickUp	Qty
Code:	Dimensions	\$/each	Pkt
ESGSL1GSW	Slim Line 1 Gang Switch	\$ 6.60	
ESGSL2GSW	Slim Line 2 Gang Switch	\$ 10.20	
ESGSL4GSW	Slim Line 4 Gang Switch	\$ 18.00	
ESGSL5GSW	Slim Line 5 Gang Switch	\$ 22.50	
ESGSL6GSW	Slim Line 6 Gang Switch	\$ 30.00	

Ph: 02 9525 0970

Fax: 02 9540 2899

Email: orders@arrowsales.com.au

Please Note All Prices Are GST Exclusive

## ELECTRICAL PRODUCTS

INSPECTION TEE				Qty
	Code:	Dimensions	\$/each	Pkt
	EIT20	20mm Inspection Tee	\$ 2.10	20
	EIT25	25mm Inspection Tee	\$ 3.00	20

GREY 90 DEG ELBOWS				Qty
	Code:	Dimensions	\$/each	Pkt
	EEL16	16mm Elbow 90 deg	\$ 0.45	20
	EEL20	20mm Elbow 90 deg	\$ 0.68	20
	EEL25	25mm Elbow 90 deg	\$ 0.95	20
	EEL32	32mm Elbow 90 deg	\$ 1.65	20

SOLID ELBOWS GREY				Qty
	Code:	Dimensions	\$/each	Pkt
	ESE20	20mm Grey Solid Elbow	\$ 0.79	20
	ESE25	25mm Grey Solid Elbow	\$ 1.10	20

STANDARD BEND GREY				Qty
	Code:	Dimensions	\$/each	Pkt
	ESB20	20mm Grey Bends	\$ 1.50	20
	ESB25	25mm Grey Bends	\$ 1.95	20
	ESB32	32mm Grey Bends	\$ 4.50	20

STANDARD BEND GREY - 90 deg				Qty
	Code:	Dimensions	\$/each	Pkt
	ESB20-90	20mm Grey 90 deg Bends	\$ 3.30	

PLASTIC FULL SADDLES				Qty
	Code	Description	\$/100	Pkt
	PCON20	20mm Plastic Saddle	\$ 0.22	100
	PCON25	25mm Plastic Saddle	\$ 0.26	100

PLASTIC STAND-OFF CLIP LOCKS				Qty
	Size	Description	\$/100	Pkt
	PCLK16	16mm Clip Lock	POA	100
	PCLK20	20mm Clip Lock	\$ 0.16	100
	PCLK25	25mm Clip Lock	\$ 0.21	100

GIRDER CLIPS				Qty
	Size		\$/100	Pkt
	EGC813	8-13mm Girder Clip	\$ 0.49	100
	EGC1620	16-20mm Girder Clip	\$ 0.56	100
	EGC2532	25-32mm Girder Clip	\$ 0.70	100

Ph: 02 9525 0970

Fax: 02 9540 2899

Email: orders@arrowsales.com.au

Please Note All Prices Are GST Exclusive

## ELECTRICAL PRODUCTS

RIGID CONDUIT - 4m LENGTHS - GREY				Qty
	Code	Description	\$/each	Pkt
	ERC16	16mm Rigid Conduit Grey	\$ 10.32	10
	ERC20	20mm Rigid Conduit Grey	\$ 7.84	10
	ERC25	25mm Rigid Conduit Grey	\$ 13.58	10
	ERC32	32mm Rigid Conduit Grey	\$ 20.29	10
	ERC40	40mm Rigid Conduit Grey	\$ 29.97	10
	ERC50	50mm Rigid Conduit Grey	\$ 44.62	10



FULL SADDLES		Zinc Plated		Hot Dipped		Qty	
	Nom. Size	Description	Code:	\$/100	Code:	\$/100	Pkt
	6	6mm FULL SADDLE	ZPS025	\$ 16.30			100
	8	8mm FULL SADDLE	ZPS031	\$ 13.23			100
	10	10mm FULL SADDLE	ZPS037	\$ 25.86			100
	12	12mm FULL SADDLE	ZPS050	\$ 13.75	GS050	\$ 29.98	100
	16	16mm FULL SADDLE	ZPS062	\$ 15.71	GS062	\$ 43.88	100
	20	20mm FULL SADDLE	ZPS075	\$ 19.56	GS075	\$ 45.94	100
	25	25mm FULL SADDLE	ZPS100	\$ 30.36	GS100	\$ 64.38	100
	32	32mm FULL SADDLE	ZPS125	\$ 61.27	GS125	\$ 113.50	20
	40	40mm FULL SADDLE	ZPS150	\$ 79.29	GS150	\$ 129.58	20
	50	50mm FULL SADDLE	ZPS200	\$ 93.08	GS200	\$ 179.40	20
	65				GS250	\$ 240.67	1
	80				GS300	\$ 839.17	1
	100				GS400	\$ 1,489.51	1



ELECTRICAL PVC RAINBOW TAPE		
CODE	\$/each	QTY
EPVCTRB	\$ 33.10	1





## ELECTRICAL PRODUCTS

HALF SADDLES - SINGLE SIDED			LIGHT PATTERN			HEAVY PATTERN		
			Galvanised			Zinc Plated		
	Code:	Description	Code:	\$/100	Qty - Pkt	Code:	\$/100	Qty - Pkt
	5	5mm HALF SADDLE	ZPC018	\$ 24.80	100			
	6	6mm HALF SADDLE	ZPC025	\$ 35.89	100			
	8	8mm HALF SADDLE	ZPC031	\$ 31.29	100			
	10	10mm HALF SADDLE	ZPC037	\$ 23.99	100			
	12	12mm HALF SADDLE				CON013	\$ 25.93	100
	16	16mm HALF SADDLE				CON016	\$ 26.42	100
	20	20mm HALF SADDLE				CON020	\$ 23.11	100
	22	22mm HALF SADDLE						
	25	25mm HALF SADDLE				CON025	\$ 27.67	100
	32	32mm HALF SADDLE				CON032	\$ 66.73	50
	40	40mm HALF SADDLE				CON040	\$ 90.33	30
	Heavy Pattern	50	50mm HALF SADDLE				CON050	\$ 105.67

HALF SADDLES - SINGLE SIDED			Hot Dipped			Stainless Steel		
								
	Code:	Description	Code:	\$/100	Qty - Pkt	Code:	\$/100	Qty - Pkt
	5	5mm HALF SADDLE						
	6	6mm HALF SADDLE						
	8	8mm HALF SADDLE						
Light Pattern	10	10mm HALF SADDLE						
	12	12mm HALF SADDLE	CON013G	\$ 58.40	100	CON013S	\$ 278.38	100
	16	16mm HALF SADDLE	CON016G	\$ 58.40	100	CON016S	\$ 207.17	100
	20	20mm HALF SADDLE	CON020G	\$ 42.64	100	CON020S	\$ 214.14	100
	22	22mm HALF SADDLE						
	25	25mm HALF SADDLE	CON025G	\$ 51.34	100	CON025S	\$ 243.34	80
	32	32mm HALF SADDLE	CON032G	\$ 108.92	50	CON032S	\$ 315.64	50
	40	40mm HALF SADDLE	CON040G	\$ 264.26	50	CON040S	\$ 403.24	30
Heavy Pattern	50	50mm HALF SADDLE	CON050G	\$ 312.45	20	CON050S	\$ 425.49	20

## CABLE



TPS CABLES - SDI		mm <sub>2</sub>	Const	Length	\$/each
Code:	Description				
ECBTPS110R	TPS Cables - RED SDI 1.5mm 100m	1.5	SDI (RED)	100M	\$ 71.30
ECBTPS115R	TPS Cables - RED SDI 1.5mm 100m	1.5	SDI (RED)	100M	\$ 86.25
ECBTPS115B	TPS Cables - BLACK SDI 1.5mm 100m	1.5	SDI (BLACK)	100M	\$ 86.25
ECBTPS115W	TPS Cables - WHITE SDI 1.5mm 100m	1.5	SDI (WHITE)	100M	\$ 86.25
ECBTPS125R	TPS Cables - RED SDI 2.5mm 100m	2.5	SDI (RED)	100M	\$ 135.70
ECBTPS140R	TPS Cables - RED SDI 4mm 100m	4	SDI (RED)	100M	\$ 228.85
ECBTPS160R	TPS Cables - RED SDI 4mm 100m	4	SDI (RED)	100M	\$ 312.80



TPS CALBES - TWIN		mm <sub>2</sub>	Const	Length	\$/each
Code:	Description				
ECBTPS210A	TPS Cables - Twin Activ 1mm 100m	1	Twin Active	100M	\$ 127.65
ECBTPS215A	TPS Cables - Twin Activ 1.5mm 100m	1.5	Twin Active	100M	\$ 151.80
ECBTPS215	TPS Cables - Twin 1.5mm 100m	1.5	Twin	100M	\$ 151.80
ECBTPS225A	TPS Cables - Twin Activ 2.5mm 100m	2.5	Twin Active	100M	\$ 257.60
ECBTPS225	TPS Cables - Twin 2.5mm 100m	2.5	Twin	100M	\$ 257.60
ECBTPS140R	TPS Cables - RED SDI 4mm 100m	16	7/1.7	100M	\$ 228.85
ECBTPS215	TPS Cables - Twin 1.5mm 100m	1.5	Twin	100M	\$ 151.80



TWIN CABLES - TWIN & EARTH		mm <sub>2</sub>	Const	Length	\$/each
Code:	Description				
ECBTPS310A	TPS Cables - Twin Earth 1mm 100m	1	Twin & Earth	100m/500m	POA
ECBTPS315A	TPS Cables - Twin Earth 1.5mm 100m	1.5	Twin & Earth	100m/500m	\$ 208.32
ECBTPS325	TPS Cables - Twin Earth 2.5mm 100m	2.5	Twin & Earth	100m/500m	\$ 353.92
ECBTPS340A	TPS Cables - Twin Earth 4mm 100m	4	Twin & Earth	100m	\$ 538.20
ECBTPS360	TPS Cables - Twin Earth 6mm 100m	6	Twin & Earth	100m	\$ 706.10

TWIN ACT NEUTRAL & EARTH BLUE		mm <sub>2</sub>	Const	Length	\$/each
Code:	Description				
ECBTPS3TAC	1.5mm Twin Act Neutral & Earth Blue	1.5	Earth Blue		\$ 301.30

## ORANGE CIRCULAR CABLES



ORANGE CIRCULAR (2Core + Earth)		mm <sub>2</sub>	Strands/mm	Length	\$/m
Code:	Description				
ECBOC2CE1	Orange Cir Cab 2C+E 1.5mm 100m	1.5	7/0.5	100m/500m	\$ 280.60
ECBOC2CE2	Orange Cir Cab 2C+E 2.5mm 100m	2.5	7/0.67	100m/500m	\$ 404.80
ECBOC2CE4	Orange Cir Cab 2C+E 4mm 100m	4	7/0.85	100m/500m	\$ 581.90
ECBOC2CE6	Orange Cir Cab 2C+E 6mm 100m	6	7/1.04	100m/500m	\$ 793.50
ECBOC2CE10	Orange Cir Cab 2C+E 10mm 100m	10	7/1.35	100m/500m	\$ 1,304.10
ECBOC2CE16	Orange Cir Cab 2C+E 16mm 100m	16	7/1.7	100m/500m	\$ 1,840.00

## CABLE



ORANGE CIRCULAR (3Core + Earth)		mm <sub>2</sub>	Strands/mm	Length	\$/m
Code:	Description				
ECBOC3CE1	Orange Cir Cab 3C+E 1.5mm 100m	1.5	7/0.5	100m/500m	\$ 317.40
ECBOC3CE2	Orange Cir Cab 3C+E 2.5mm 100m	2.5	7/0.67	100m/500m	\$ 529.00
ECBOC3CE4	Orange Cir Cab 3C+E 4mm 100m	4	7/0.85	100m/500m	\$ 791.20
ECBOC3CE6	Orange Cir Cab 3C+E 6mm 100m	6	7/1.04	100m/500m	\$ 1,058.00
ECBOC3CE10	Orange Cir Cab 3C+E 10mm 100m	10	7/1.35	100m/500m	\$ 1,745.70
ECBOC3CE16	Orange Cir Cab 3C+E 16mm 100m	16	7/1.7	100m/500m	\$ 1,840.00
ECBOC3CE1500	Orange Cir Cab 3C+E 1.5mm 500m				\$ 1,587.00



ORANGE CIRCULAR (4Core + Earth)		mm <sub>2</sub>	Strands/mm	Length	\$/m
Code:	Description				
ECBOC4CE1	Orange Cir Cab 4C+E 1.5mm 100m	1.5	7/0.5	100m/500m	\$ 397.90
ECBOC4CE2	Orange Cir Cab 4C+E 2.5mm 100m	2.5	7/0.67	100m/500m	\$ 694.60
ECBOC4CE4	Orange Cir Cab 4C+E 4mm 100m	4	7/0.85	100m/500m	\$ 972.90
ECBOC4CE6	Orange Cir Cab 4C+E 6mm 100m	6	7/1.04	100m/500m	\$ 1,324.80
ECBOC4CE10	Orange Cir Cab 4C+E 10mm 100m	10	7/1.35	100m/500m	\$ 1,324.80
ECBOC4CE16	Orange Cir Cab 4C+E 16mm 100m	16	7/1.7	100m/500m	\$ 3,284.40



ORANGE CIRCULAR (5Core + Earth)		mm <sub>2</sub>	Strands/mm	Length	\$/m
Code:	Description				
ECBOC5CE1	Orange Cir Cab 5C+E 1.5mm 100m	1.5		100m/500m	\$ 553.73



ORANGE CIRCULAR (6Core + Earth)		mm <sub>2</sub>	Strands/mm	Length	\$/m
Code:	Description				
ECBOC6CE1	Orange Cir Cab 6C+E 1.5mm 100m	1.5		100m/500m	\$ 676.78

## Building Wire Cables

BUILDING WIRE AS/NZS 5000.1 PVC75 0.6/1kv		mm <sub>2</sub>	Colour	Length	\$/EACH
Code:	Description				
ECBBW15R	Build Wire Red 1.5mm 100m	1.5	Red	100m	\$ 86.25
ECBBW15BLK	Build Wire Black 1.5mm 100m	1.5	Black	100m	\$ 86.25
ECBBW15W	Build Wire White 1.5mm 100m	1.5	White	100m	\$ 86.25
ECBBW15BLU	Build Wire Blue 1.5mm 100m	1.5	Blue	100m	\$ 86.25
ECBBW15GRY	Build Wire Grn+Yel 1.5mm 100m	1.5	Green & Yellow	100m	\$ 86.25
ECBBW25R	Build Wire Red 2.5mm 100m	2.5	Red	100m	\$ 118.45
ECBBW25BLK	Build Wire Black 2.5mm 100m	2.5	Black	100m	\$ 118.45
ECBBW25W	Build Wire White 2.5mm 100m	2.5	White	100m	\$ 118.45
ECBBW25BLU	Build Wire Blue 2.5mm 100m	2.5	Blue	100m	\$ 118.45
ECBBW25GRY	Build Wire Grn+Yel 2.5mm 100m	2.5	Green & Yellow	100m	\$ 118.45
ECBBW40R	Build Wire Red 4mm 100m	4	Red	100m	\$ 197.80
ECBBW40BLK	Build Wire Black 4mm 100m	4	Black	100m	\$ 197.80
ECBBW40GRY	Build Wire Grn+Yel 4mm 100m	4	Green & Yellow	100m	\$ 197.80
ECBBW60R	Build Wire Red 6mm 100m	6	Red	100m	\$ 267.95
ECBBW60BLK	Build Wire Black 6mm 100m	6	Black	100m	\$ 267.95
ECBBW60GRY	Build Wire Grn+Yel 6mm 100m	6	Green & Yellow	100m	\$ 267.95
ECBBW100R	Build Wire Red 10mm 100m	10	Red	100m	\$ 478.40
ECBBW100BLK	Build Wire Black 10mm 100m	10	Black	100m	\$ 478.40
ECBBW100GRY	Build Wire Grn+Yel 10mm 100m	10	Green & Yellow	100m	\$ 478.40
ECBBW160R	Build Wire Red 16mm 100m	16	Red	100m	\$ 694.60
ECBBW160BLK	Build Wire Black 16mm 100m	16	Black	100m	\$ 694.60
ECBBW160GRY	Build Wire Grn+Yel 16mm 100m	16	Green & Yellow	100m	\$ 694.60

## Shielded Data Cable











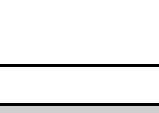

Shielded Data Cable AS/NZS 5000.1 PVC75 0.6/1kv		mm <sub>2</sub>	Colour	Length	\$/Roll
Code:	Description				
ECBSC02	DELETE	0.2	Grey	100m	\$ 36.42
ECBSC0402	SECURITY CABLE 4 CORE 0.44MM				\$ 71.37
ECBSC0204	0.22mm x 4C Shielded Grey Data Cable	0.22	Grey	100m	\$ 131.10
ECBSC07032500	0.5mm x 2 Pair Shielded Black Cable 500m	0.5	Black	500m	\$ 1,069.50
ECBSC07034500	0.5mm x 4 Pair Shielded Black Cable 500m	0.5	Black	500m	\$ 2,139.00
ECBSC07036	0.5mm x 6 Pair Shielded Black Cable 100m	0.5	Black	100m	\$ 641.70
ECBSC07032	0.5mm x 1 Pair Shielded Black Cable 100m	0.5	Black	100m	\$ 110.40
ECBSC07303	0.5mm x 3C Shielded Cable	0.5		500m	\$ 167.90
ECBSC075	0.75 Single Twin shielded Data Cable	0.75	Black	100m	\$ 207.00
ECBSC075P2	0.75mm Two Tw Pair Shielded Black Cable	0.75	Black	100m	\$ 317.40
ECBSC10	1mm Single Twin shielded Data Cable	1	Black	100m	\$ 213.90
ECBSC105	1.5mm Twin Shielded Black Cable	1.5	Black	100m	\$ 215.05
ECBSC10500	1.5mm Twin Shield Black Cable 500m	1.5	Black	100m	\$ 1,035.00
ECBSCF850	0.5mm Figure Eight 14020 Security Cable	0.5	Grey	100m	\$ 86.14

LT3 STD Laddertray					CABLE TRAY				
LT3 STD Laddertray Galvanised	Nom. Size	Code:	PICKUP		LT3 Radius Plate	Nom. Size	Code:	PICKUP	
			\$/each	QTY				\$/each	QTY
	150mm	CLSTD150	\$ 53.73	1			CLSTRPG	\$ 26.68	1
	300mm	CLSTD300	\$ 65.61	1					
	450mm	CLSTD450	\$ 86.40	1					
	600mm	CLSTD600	\$ 108.00	1					
LT3 Splice	Nom.	#N/A	PICKUP		SBH Splice Bolt & SNH Splice Nut	Nom. Size	Code:	PICKUP	
			\$/each	QTY				\$/each	QTY
		CLSTSG	\$ 3.78	1			CLSTNUT	\$ 0.65	1
							CLSTBOT	POA	1
LT3 Hold Down	Nom. Size	Code:	PICKUP		Cable Tray	Nom. Size	Code:	PICKUP	
			\$/each	QTY				\$/each	QTY
		CLSTDHDG	\$ 2.43	1		75mm	CLGB75	\$ 18.55	1
						100mm	CLGB100	\$ 28.22	1
						150mm	CLGB150	\$ 28.25	1
						225mm	CLGB225	\$ 44.55	1
						300mm	CLGB300	\$ 63.99	1
						450mm	CLGB450	\$ 70.82	1
					600mm	CLGB600	\$ 96.96	1	
LT3 RISER LINK	Nom. Size	Code:	PICKUP		Cable Tray Bend	Nom. Size	Code:	PICKUP	
			\$/each	QTY				\$/each	QTY
		CLSTDRLG	\$ 2.16	1		75mm	CLGBTB75	POA	1
						100mm	CLGBTB100	POA	1
						150mm	CLGBTB150	\$ 39.61	1
						225mm	CLGBTB225	POA	1
						300mm	CLGBTB300	POA	1
						450mm	CLGBTB450	POA	1
						600mm	CLGBTB600	POA	1
LT3 Tee/Cross	Nom. Size	Code:	PICKUP		Cable Tray Tee	Nom. Size	Code:	PICKUP	
			\$/each	QTY				\$/each	QTY
						75mm	CLGBT75	POA	1
						100mm	CLGBT100	POA	1
						150mm	CLGBT150	\$ 40.99	1
						225mm	CLGBT225	POA	1
						300mm	CLGBT300	POA	1
						450mm	CLGBT450	POA	1
Cable Tray Tee HDG	Nom. Size	Code:	PICKUP			600mm	CLGBT600	POA	1
			\$/each	QTY					
	300mm	CLCTT300G	\$ 84.83	1					

Ph: 02 9525 0970

Fax: 02 9540 2899

Email: orders@arrowsales.com.au



NEMA 1 Cable Ladder									
NEMA 1 Cable Ladder	Nom. Size	Code:	PICKUP		NEMA 1 Cable Ladder - Cross	Nom. Size	Code:	PICKUP	
			\$/each	QTY				\$/each	QTY
	150mm	CLNN1LAD150M3	\$ 225.72	1		150mm	CLNN1X150	\$ 203.90	1
	150mm	CLNN1LAD150	\$ 225.72	1		300mm	CLNN1X300	\$ 234.14	1
	300mm	CLNN1LAD300	\$ 246.51	1		450mm	CLNN1X450	\$ 283.39	1
	450mm	CLNN1LAD450	\$ 276.21	1		600mm	CLNN1X600	\$ 300.67	1
	600mm	CLNN1LAD600	\$ 288.09	1		900mm	CLNN1X900	POA	1
NEMA 1 Cable Ladder - Bend	Nom. Size	Code:	PICKUP		NEMA 1 Cable Ladder - Straight Reducer	Nom. Size	Code:	PICKUP	
			\$/each	QTY				\$/each	QTY
	150mm	CLNN1SW150	\$ 85.21	1		300mm	CLNN1SR300150H	POA	1
	300mm	CLNN1SW300	\$ 104.46	1		450mm	CLNN1SR450150H	POA	1
	450mm	CLNN1SW450	\$ 124.93	1		450mm	CLNN1SR450300H	POA	1
	600mm	CLNN1SW600	\$ 145.40	1		600mm	CLNN1SR600150H	POA	1
	900mm	CLNN1SW900	POA	1		600mm	CLNN1SR600300H	POA	1
	150mm	CLNN1T150	\$ 162.38	1		600mm	CLNN1SR600450H	POA	1
	300mm	CLNN1T300	\$ 184.87	1		900mm	CLNN1SR900150H	POA	1
	450mm	CLNN1T450	\$ 214.38	1		900mm	CLNN1SR900300H	POA	1
	600mm	CLNN1T600	\$ 230.12	1		900mm	CLNN1SR900450H	POA	1
	900mm	CLNN1T900	POA	1		900mm	CLNN1SR900600H	POA	1
NEMA 1 Cable Ladder - Tee	Nom. Size	Code:	PICKUP		NEMA 1 Cable Ladder - Left Hand Reducer	Nom. Size	Code:	PICKUP	
			\$/each	QTY				\$/each	QTY
NEMA 1 Cable Ladder - External Riser	Nom. Size	Code:	PICKUP		NEMA 1 Cable Ladder - Left Hand Reducer	Nom. Size	Code:	PICKUP	
			\$/each	QTY				\$/each	QTY
	150mm	CLNN1ER150	\$ 152.15	1		300mm	CLNN1LHR300150H	POA	1
	300mm	CLNN1ER300	\$ 127.87	1		450mm	CLNN1LHR450150H	POA	1
	450mm	CLNN1ER450	\$ 133.62	1		450mm	CLNN1LHR450300H	POA	1
	600mm	CLNN1ER600	\$ 145.88	1		600mm	CLNN1LHR600150H	POA	1
	900mm	CLNN1ER900	POA	1		600mm	CLNN1LHR600300H	POA	1
	150mm	CLNN1IR150	\$ 152.15	1		600mm	CLNN1LHR600450H	POA	1
	300mm	CLNN1IR300	\$ 127.87	1		900mm	CLNN1LHR900150H	POA	1
	450mm	CLNN1IR450	\$ 152.15	1		900mm	CLNN1LHR900300H	POA	1
	600mm	CLNN1IR600	\$ 145.88	1		900mm	CLNN1LHR900450H	POA	1
	900mm	CLNN1IR900	POA	1		900mm	CLNN1LHR900600H	POA	1
NEMA 1 Cable Ladder - Internal Riser	Nom. Size	Code:	PICKUP		NEMA 1 Cable Ladder - Right Hand Reducer	Nom. Size	Code:	PICKUP	
			\$/each	QTY				\$/each	QTY
NEMA 1 Cable Ladder - Right Hand Reducer	Nom. Size	Code:	PICKUP		NEMA 1 Cable Ladder - Right Hand Reducer	Nom. Size	Code:	PICKUP	
			\$/each	QTY				\$/each	QTY
	300mm	CLNN1RHR300150H	POA	1		300mm	CLNN1RHR300150H	POA	1
	450mm	CLNN1RHR450150H	POA	1		450mm	CLNN1RHR450150H	POA	1
	450mm	CLNN1RHR450300H	POA	1		450mm	CLNN1RHR450300H	POA	1
	600mm	CLNN1RHR600150H	POA	1		600mm	CLNN1RHR600150H	POA	1
	600mm	CLNN1RHR600300H	POA	1		600mm	CLNN1RHR600300H	POA	1
	600mm	CLNN1RHR600450H	POA	1		900mm	CLNN1RHR900150H	POA	1
	900mm	CLNN1RHR900150H	POA	1		900mm	CLNN1RHR900150H	POA	1
	900mm	CLNN1RHR900300H	POA	1		900mm	CLNN1RHR900300H	POA	1
	900mm	CLNN1RHR900450H	POA	1		900mm	CLNN1RHR900450H	POA	1
	900mm	CLNN1RHR900600H	POA	1		900mm	CLNN1RHR900600H	POA	1



Ph: 02 9525 0970



Fax: 02 9540 2899



Email: orders@arrowsales.com.au





NEMA 1 Splice Plate	Nom. Size	Code:	PICKUP		NEMA 1 Hold Down Kit	Nom. Size	Code:	PICKUP	
			\$/each	QTY				\$/each	QTY
		CLNN1SPC	\$ 10.69	1			CLNN1HOLD	\$ 5.51	1

NEMA 1 Vertical Splice Plate	Nom. Size	Code:	PICKUP		NEMA 1 Splice Hanging Bracket	Nom. Size	Code:	PICKUP	
			\$/each	QTY				\$/each	QTY
		CLNN1VERT	\$ 15.15	1			CLNN1SHH	POA	1

NEMA Horizontal 1 Splice Plate	Nom. Size	Code:	PICKUP		NEMA 2 Cable Ladder	Nom. Size	Code:	PICKUP	
			\$/each	QTY				\$/each	QTY
		CLNN1HOR	\$ 21.36	1		150mm 300mm 450mm 600mm 900mm	CLNN2LAD150 CLNN2LAD300 CLNN2LAD450 CLNN2LAD600 CLNN2LAD900	\$ 269.33 \$ 292.95 \$ 317.25 \$ 341.82 \$ 398.52	1 1 1 1 1

NEMA 1 Cover Clamp	Nom. Size	Code:	PICKUP		NEMA 2 Cable Ladder	Nom. Size	Code:	PICKUP	
			\$/each	QTY				\$/each	QTY
		CLNN1CC	\$ 5.00	1		150mm 300mm 450mm 600mm 900mm	CLNN2L150RIH CLNN2L300RIH CLNN2L450RIH CLNN2L600RIH CLNSN2L900RIH	POA POA POA POA POA	1 1 1 1 1

NEMA 1 Divider Strip	Nom. Size	Code:	PICKUP		NEMA 2 Cable Ladder - Bend	Nom. Size	Code:	PICKUP	
			\$/each	QTY				\$/each	QTY
		CLNNIDS	POA	1		150mm 300mm 450mm 600mm 900mm	CLNN2B1504H CLNN2B3004H CLNN2B4504H CLNN2B6004H CLNN2B9004H	\$ 122.69 \$ 197.05 \$ 139.97 \$ 148.61 \$ 159.84	1 1 1 1 1

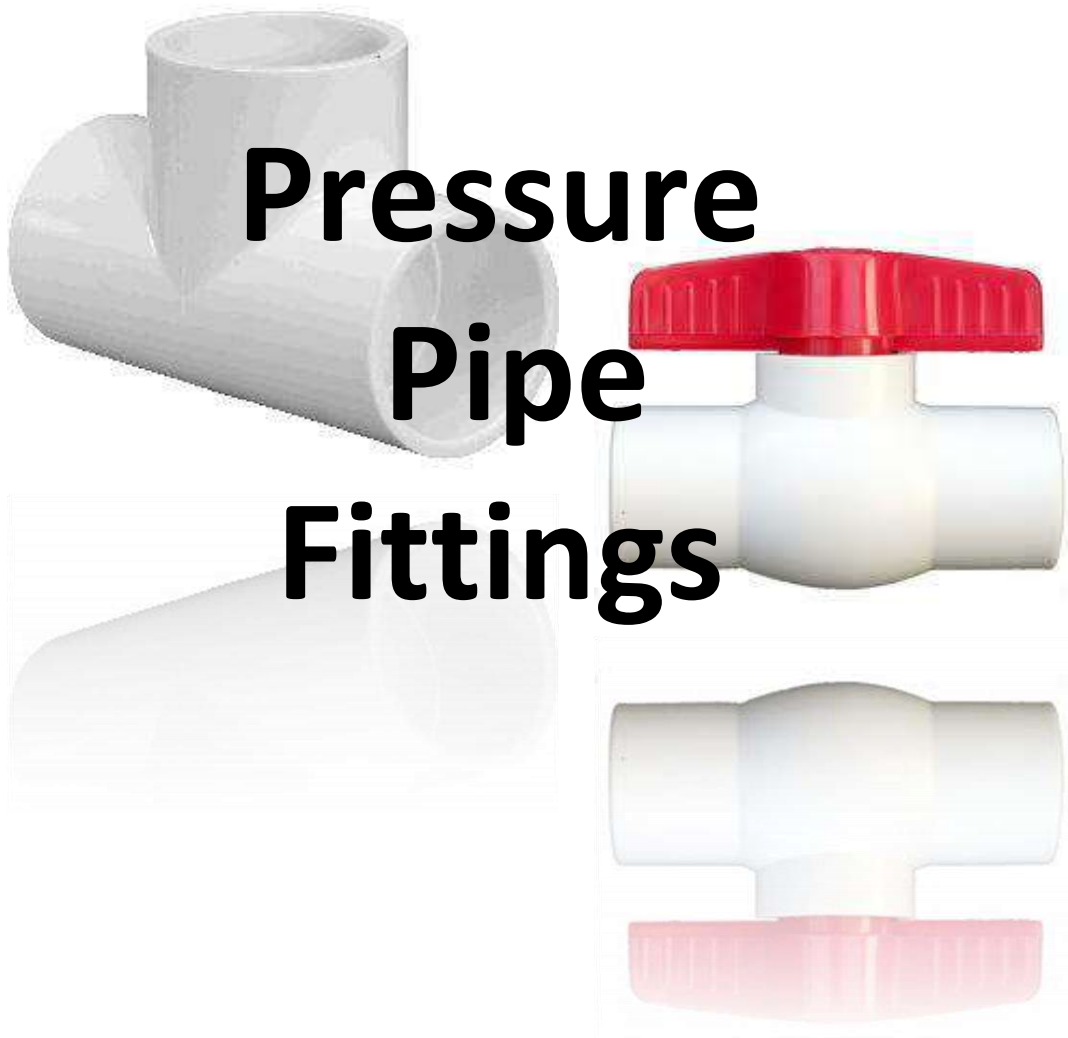

## CLASS 18 PRESSURE PIPE FITTINGS AS/NZS1477

Valve Adaptor Cat. No. 2	Nom. Size	Code	Individual		Carton	
			\$/each	Qty	\$/each	Qty
	15	SVA05	\$1.53	Each	\$ 1.53	50
	20	SVA07	\$1.91	Each	\$ 1.91	50
	25	SVA10	\$2.90	Each	\$ 2.90	50
	32	SVA12	\$3.13	Each	\$ 3.13	50
	40	SVA15	\$3.74	Each	\$ 3.74	50
	50	SVA20	\$4.89	Each	\$ 4.89	50
	80	SVA30	\$31.25	Each	\$ 31.25	50

Faucet Adaptor Cat. No. 3	Nom. Size	Code	Individual		Carton	
			\$/each	Qty	\$/each	Qty
	15	SFA05	\$1.99	Each	\$ 1.99	50
	20	SFA07	\$2.32	Each	\$ 2.32	50
	25	SFA10	\$3.07	Each	\$ 3.07	50
	32	SFA12	\$4.66	Each	\$ 4.66	50
	40	SFA15	\$5.61	Each	\$ 5.61	50
	50	SFA20	\$7.41	Each	\$ 7.41	50
	80	SFA30	\$57.48	Each	\$ 61.59	50
	100	SFA40	\$72.77	Each	\$ 77.96	50

Reducer Bushing (Slip x Slip) Cat. No. 5	Nom. Size	Code	Individual		Carton	
			\$/each	Qty	\$/each	Qty
	20 x 15	SRB0750	\$0.95	Each	\$ 0.95	50
	25 x 15	SRB1005	\$1.82	Each	\$ 1.82	50
	25 x 20	SRB1007	\$1.82	Each	\$ 1.82	50
	32 x 20	SRB1207	\$2.08	Each	\$ 2.08	50
	32 x 25	SRB1210	\$2.36	Each	\$ 2.36	50
	40 x 20	SRB1507	\$2.34	Each	\$ 2.34	50
	40 x 25	SRB1510	\$3.07	Each	\$ 3.07	50
	40 x 32	SRB1512	\$3.40	Each	\$ 3.40	50
	50 x 25	SRB2010	\$4.31	Each	\$ 4.31	50
	50 x 32	SRB2012	\$3.73	Each	\$ 3.73	50
	50 x 40	SRB2015	\$4.97	Each	\$ 4.97	50
	65 x 50	SRB2520	\$9.36	Each	\$ 9.36	10
	80 x 50	SRB3020	\$8.17	Each	\$ 8.17	10
	80 x 65	SRB3025	\$16.81	Each	\$ 16.81	10
	100 x 50	SRB4020	\$35.64	Each	\$ 35.64	10
	100 x 80	SRB4030	\$22.92	Each	\$ 22.92	10
	150 x 100	SRB6040	\$109.18	Each	\$ 109.18	10
	200 x 150	SRB8060	\$218.88	Each	\$ 218.88	5
	225 x 200	SRB9080	\$558.40	Each	\$ 558.40	5
	250 x 200	SRB10080	\$509.07	Each	\$ 509.07	1
250 x 225	SRB10090	\$640.40	Each	\$ 640.40	1	

## CLASS 18 PRESSURE PIPE FITTINGS AS/NZS1477

Cap (Slip x Slip) Cat. No. 6	Nom. Size	Code	Individual		Carton	
			\$/each	Qty	\$/each	Qty
	15	SKS05	\$0.80	Each	\$ 0.80	50
	20	SKS07	\$1.15	Each	\$ 1.15	50
	25	SKS10	\$1.82	Each	\$ 1.82	50
	32	SKS12	\$2.38	Each	\$ 2.38	50
	40	SKS15	\$2.38	Each	\$ 2.38	50
	50	SKS20	\$2.83	Each	\$ 2.83	50
	65	SKS25	\$27.78	Each	\$ 27.78	10
	80	SKS30	\$9.48	Each	\$ 9.48	10
	100	SKS40	\$19.78	Each	\$ 19.78	10
	150	SKS60	\$86.08	Each	\$ 86.08	10
	200	SKS80	\$378.29	Each	\$ 378.29	10

Coupling (Slip x Slip) Cat. No. 7	Nom. Size	Code	Individual		Carton	
			\$/each	Qty	\$/each	Qty
	15	SCS05	\$0.65	Each	\$ 0.65	50
	20	SCS07	\$0.74	Each	\$ 0.74	50
	25	SCS10	\$1.25	Each	\$ 1.25	50
	32	SCS12	\$1.72	Each	\$ 1.72	50
	40	SCS15	\$1.72	Each	\$ 1.72	50
	50	SCS20	\$2.65	Each	\$ 2.65	50
	65	SCS25	\$13.89	Each	\$ 13.89	50
	80	SCS30	\$15.51	Each	\$ 15.51	25
	100	SCS40	\$19.95	Each	\$ 19.95	25
	150	SCS60	\$92.08	Each	\$ 92.08	5
	200	SCS80	\$232.55	Each	\$ 232.55	5
	250	SCS100	\$596.95	Each	\$ 596.95	5

45 Degree Elbow (Slip x Slip) Cat. No. 10	Nom. Size	Code	Individual		Carton	
			\$/each	Qty	\$/each	Qty
	15	SAS05	\$1.25	Each	\$ 1.25	50
	20	SAS07	\$1.81	Each	\$ 1.81	50
	25	SAS10	\$2.35	Each	\$ 2.35	50
	32	SAS12	\$3.90	Each	\$ 3.90	50
	40	SAS15	\$3.22	Each	\$ 3.22	50
	50	SAS20	\$5.12	Each	\$ 5.12	50
	65	SAS25	\$37.02	Each	\$ 37.02	50
	80	SAS30	\$21.03	Each	\$ 21.03	50
	100	SAS40	\$37.18	Each	\$ 37.18	25
	150	SAS60	\$141.33	Each	\$ 141.33	25
	200	SAS80	\$401.16	Each	\$ 401.16	25

90 Degree Elbow (Slip x Slip) Cat. No. 10	Nom. Size	Code	Individual		Carton	
			\$/each	Qty	\$/each	Qty
	250	SAS100	\$ 1,548.56	Each	1548.56	

Ph: 02 9525 0970

Fax: 02 9540 2899

Email: orders@arrowsales.com.au

Please Note All Prices Are GST Exclusive

## CLASS 18 PRESSURE PIPE FITTINGS AS/NZS1477

Reducer Socket (Slip x Slip) Cat. No. 8	Nom. Size	Code	Individual		Carton	
			\$/each	Qty	\$/each	Qty
	20x15	SRS0750	\$ 1.10	Each	\$ 0.98	50
	25x15	SRS1005	\$ 1.69	Each	\$ 1.69	50
	25x20	SRS1007	\$ 1.82	Each	\$ 1.82	50
	32x20	SRS1207	\$ 2.46	Each	\$ 2.20	50
	32x25	SRS1210	\$ 2.48	Each	\$ 2.22	50
	40x20	SRS1507	\$ 3.30	Each	\$ 2.96	50
	40x25	SRS1510	\$ 3.29	Each	\$ 2.95	50
	40x32	SRS1512	\$ 3.77	Each	\$ 3.52	50
	50x20	SRS2007	\$ 4.33	Each	\$ 3.65	50
	50x25	SRS2010	\$ 4.31	Each	\$ 4.31	50
	50x32	SRS2012	\$ 4.78	Each	\$ 4.24	50
	50x40	SRS2015	\$ 4.70	Each	\$ 4.20	50
	65x50	SRS2520	\$ 9.28	Each	\$ 9.28	50
	80x20	SRS3007	\$ 8.36	Each	\$ 8.37	50
	80x25	SRS3010	\$ 14.61	Each	\$ 14.61	50
	80x50	SRS3020	\$ 9.68	Each	\$ 9.69	50
	80x65	SRS3025	\$ 14.66	Each	\$ 14.66	50
	100x50	SRS4020	\$ 14.65	Each	\$ 12.28	50
	100x80	SRS4030	\$ 17.33	Each	\$ 13.13	50
	150x100	SRS6040	\$ 68.66	Each	\$ 58.02	10
	200x150	SRS8060	\$ 239.06	Each	\$ 204.91	5
	250x200	SRS10080	\$ 485.48	Each	\$ 430.64	5

Tee (Slip x Slip) Cat. No. 19	Nom. Size	Code	Individual		Carton	
			\$/each	Qty	\$/each	Qty
	15	STS05	\$ 1.19	Each	\$ 1.17	50
	20	STS07	\$ 1.19	Each	\$ 1.13	50
	20x15	STS0705	\$ 1.63	Each	\$ 1.42	50
	25	STS10	\$ 2.01	Each	\$ 1.90	50
	25x15	STS1005	\$ 2.61	Each	\$ 2.27	50
	25x20	STS1007	\$ 3.07	Each	\$ 2.56	50
	32	STS12	\$ 3.56	Each	\$ 3.05	50
	40	STS15	\$ 4.13	Each	\$ 4.13	50
	50	STS20	\$ 5.46	Each	\$ 3.86	50
	50x20	STS2007	\$ 7.30	Each	\$ 6.35	50
	50x25	STS2010	\$ 7.30	Each	\$ 6.35	50
	50x40	STS2015	\$ 7.30	Each	\$ 6.35	50
	65	STS25	\$ 58.22	Each	\$ 46.58	50
	80	STS30	\$ 22.67	Each	\$ 17.75	50
	100	STS40	\$ 34.74	Each	\$ 32.37	50
	150	STS60	\$ 201.34	Each	\$ 178.21	5
	200	STS80	\$ 669.80	Each	\$ 574.12	5
	225	STS90	\$ 1,443.94	Each	\$ 1,289.24	5
	250	STS100	\$ 2,378.47	Each	\$ 2,162.24	2
	300	STS150	\$ 1,285.89	Each	\$ -	

## Class 18 Pressure Pipe Fittings AS/NZS1477

PVC Barrel Union Cat 22	Nom. Size	Code	Individual		Carton	
			\$/each	Qty	\$/each	Qty
	15	SBU05	\$ 4.16	Each	\$ 3.65	50
	20	SBU07	\$ 5.22	Each	\$ 3.97	50
	25	SBU10	\$ 7.80	Each	\$ 5.94	50
	32	SBU12	\$ 10.18	Each	\$ 7.74	50
	40	SBU15	\$ 13.71	Each	\$ 10.41	50
	50	SBU20	\$ 19.69	Each	\$ 14.95	50
	65	SBU25	\$ 46.32	Each	\$ 35.34	50
	80	SBU30	\$ 115.97	Each	\$ 115.97	50
	100	SBU40	\$ 108.89	Each	\$ 84.70	50

Faucet Tee (Slip x FPT) Cat. No. 21	Nom. Size	Code	Individual	
			\$/each	Qty
	20	STT07	\$ 2.70	Each
	20x15	STT0705	\$ 2.24	Each
	25x15	STT1005	\$ 3.52	Each
	25x20	STT1007	\$ 3.88	Each
	32	STT12	\$ 9.95	Each
	32x25	STT1210	\$ -	Each
	40	STT15	\$ 9.59	Each
	40x15	STT1505	\$ 5.01	Each
	40x20	STT1507	\$ 12.20	Each
	40x25	STT1510	\$ 11.77	Each
	50	STT20	\$ 12.70	Each
	50x20	STT2007	\$ 12.90	Each
	50x25	STT2010	\$ 15.54	Each
	100x50	STS4020	\$ 32.35	Each



## Pressure Pipe Fittings

Compression Coupling	Nom. Size	Code	Individual		Carton	
			\$/each	Qty	\$/each	Qty
	15	SCC05	\$ 4.80	Each	\$ 3.74	25
	20	SCC07	\$ 6.11	Each	\$ 5.43	25
	25	SCC10	\$ 7.89	Each	\$ 7.01	25
	32	SCC12	\$ 10.82	Each	\$ 9.62	25
	40	SCC15	\$ 12.73	Each	\$ 11.31	25
	50	SCC20	\$ 16.53	Each	\$ 14.70	25
	65	SCC25	\$ 39.53	Each	\$ 35.40	25
	80	SCC30	\$ 63.60	Each	\$ 56.89	25
	100	SCC40	\$ 102.27	Each	\$ 95.45	20
	150	SCC60	\$ 199.00	Each	\$ 185.74	10

Ball Check Valve - Solvent Weld	Nom. Size	Code	Individual		Carton	
			\$/each	Qty	\$/each	Qty
	20	SCBV07	\$ 18.26	Each	\$ 17.04	25
	25	SCBV10	\$ 26.38	Each	\$ 24.62	25
	32	SCBV12	\$ 43.36	Each	\$ 43.37	25
	40	SCBV15	\$ 38.73	Each	\$ 36.15	25
	50	SCBV20	\$ 53.57	Each	\$ 50.00	25

Reducer Faucet Bushing (Slip x Slip)	Nom. Size	Code	Individual		Carton	
			\$/each	Qty	\$/each	Qty
	25 x 20	SRT1007	\$ 1.74	Each	\$ 1.69	50
	40 x 20	SRT1507	\$ 8.36	Each	\$ 7.35	50
	40 x 25	SRT1510	\$ 9.54	Each	\$ 8.38	50
	50 x 20	SRT2007	\$ 12.75	Each	\$ 11.21	50
	50 x 25	SRT2010	\$ 17.85	Each	\$ 15.69	50

Ball Valves (Slip x Slip) Sovent Weld	Nom. Size	Code	Individual		Carton	
			\$/each	Qty	\$/each	Qty
	15	SBV05	\$ 5.41	Each	\$ 4.03	50
	20	SBV07	\$ 7.01	Each	\$ 5.23	50
	25	SBV10	\$ 10.04	Each	\$ 7.49	50
	32	SBV12	\$ 14.24	Each	\$ 11.60	50
	40	SBV15	\$ 19.78	Each	\$ 14.75	50
	50	SBV20	\$ 28.69	Each	\$ 20.79	25
	65	SBV25	\$ 91.03	Each	\$ 79.86	25
	80	SBV30	\$ 108.40	Each	\$ 74.68	25
	100	SBV40	\$ 188.90	Each	\$ 133.60	20

Black PVC TEE - Cat. No. 19	Nom. Size	Code	Individual		Carton	
			\$/each	Qty	\$/each	Qty
	40	STS15B	\$ 2.13	Each	\$ -	

Black 45 deg. PVC Elbow - Cat. No. 10	Nom. Size	Code	Individual		Carton	
			\$/each	Qty	\$/each	Qty
	40	SAS15B	\$ 1.93	Each	\$ -	

Ph: 02 9525 0970

Fax: 02 9540 2899

Email: orders@arrowsales.com.au

Please Note All Prices Are GST Exclusive

## PRESSURE PIPE FITTING



Ball Valves (Slip x Slip)

Double Union



Ball Valves FTP x FTP

BSP Threaded

Nom. Size	Code	Individual	
		\$/each	Qty
25	SBVDU25	\$ 46.39	1
40	SBVDU40	\$ 87.99	1
50	SBVDU50	\$ 104.67	1
80	SBVDU80	\$ 126.43	1
100	SBVDU100	\$ 241.37	1

Nom. Size	Code	Individual	
		\$/each	Qty
25	SBVDUT25	\$ 42.52	1
80	SBVDUT80	\$ -	1

## PRESSURE PIPE



Nom. Size	Code	Class	Pipe Length	Pack	
				\$/each	0
15	PD15ACR	9	4m	\$ 12.86	20
20	PD20ACR	9	4m	\$ 17.28	20
25	PD25ACR	9	4m	\$ 24.00	10
32	PD32ACR	9	4m	\$ 25.22	10
20	PD20CL12	12	6m	\$ 23.39	10
25	PD25CL12	12	6m	\$ 39.51	10
32	PD32CL12	12	6m	\$ 60.24	10
40	PD40CL9	9	6m	\$ 43.06	1
40	PD40CL12	12	6m	\$ 62.08	1
50	PD50CL9	9	6m	\$ 61.33	1
50	PD50CL12	12	6m	\$ 74.70	1
65	PD65CL12	12	6m	\$ -	1
80	PD80CL9	9	6m	\$ 110.24	1
80	PD100CL9	9	6m	\$ -	1
100	PD100CL12	12	6m	\$ 371.58	1
150	PD150CL12	12	6m	\$ -	1
200	PD200CL12	12	6m	\$ -	1
250	PD250CL12	12	6m	\$ -	1

## PRESSURE PIPE FITTINGS

Drilling Flanges (Fixed) Cat. No 16	Nom. Size	Code	Individual	Qty
			\$/each	
	15	SFNG05	\$ 14.16	25
	20	SFNG07	\$ 15.44	25
	25	SFNG10	\$ 16.40	25
	32	SFNG12	\$ 20.01	25
	40	SFNG15	\$ 21.38	25
	50	SFNG20	\$ 24.35	25
	65	SFNG25	\$ 46.55	25

Rubber Gaskets	Nom. Size	Code	Individual	Qty
			\$/each	
	15	SRG05	\$ 2.19	20
	20	SRG07	\$ 2.41	20
	25	SRG10	\$ 8.64	20
	32	SRG12	\$ 3.91	20
	40	SRG15	\$ 3.65	20
	50	SRG20	\$ 4.02	20
	65	SRG25	\$ 4.42	20
	80	SRG30	\$ 7.29	20
	100	SRG40	\$ 8.55	20
	150	SRG60	\$ 10.74	20
	200	SRG80	\$ 12.28	20

Flange Loose Ring (Vanstones)	Nom. Size	Code	Individual	Qty	Bulk	Qty
			\$/each		\$/each	
	50	VAN50	\$51.99	Each	\$ 51.99	20
	80	VAN80	\$38.18	Each	\$ 26.52	20
	100	VAN100	\$49.44	Each	\$ 34.33	20
	150	VAN150	\$145.81	Each	\$ 101.26	10
	200	VAN200	\$233.40	Each	\$ 162.08	10
	250	VAN250	\$621.94	Each	\$ 431.90	5
	300	VAN300	\$335.94	Each	\$ -	

## PRESSURE PIPE FITTINGS

PVC Solvent Pressure Pipe	Type	Weight	Code	Individual		
				\$/each	Qty	
	CLEAR	100	SOL100	\$ 5.83	60	
	CLEAR	500	SOL500	\$ 18.68	20	
	BLUE	250	SOLB250	\$ 14.04	1	
	BLUE	500	SOLB500	\$ 18.68	1	
	GREEN	500	SOLG500	\$ 14.79	1	
	CLEAR	500	SOLGN500	\$ 32.65	1	
	Clear PVC Glue Type P 500ml					
	RED	500	SOLP500	\$ 10.98	1	
	CLEAR	500	SOLPC500	\$ 10.98	1	
	PVC Clear Priming Fluid - 500ml					
	CLEAR	1,000	SOLT1L	\$ 66.99	1	
	1 Litre Insulation Adhesive					
	CLEAR	500	SOLT500	\$ 46.77	1	
	520 Adhesive 500ml Insulation Glue					

## PRESSURE PIPE FITTINGS

Roof Flashings	Size	Code	Individual	
			\$/each	Qty
	Flashing No1 Grey 6-60mm	FLASH660	\$ 10.80	1
	Flashing No2 Grey 50-80mm	FLASH5080	\$ 16.80	1
	Flashing No3 Grey 60-110mm	FLASH60110	\$ 25.20	1
	Flashing No4 Grey 75-150mm	FLASH75150	\$ 36.00	1
	Flashing No.5 Grey 110-170mm	FLASH110170	\$ 56.40	1

Black Flashing Square	Size	Code	Individual	
			\$/each	Qty
	Black Flashing Square 0-35mm	FLASHSQT0	\$ 10.44	1
	Flashing No1 Black 0-55mm	FLASHSQT1	\$ 13.11	1
	Flashing No2 Black 3-100mm	FLASHSQT2	\$ 20.05	1
	Flashing No3 Black 80-175mm	FLASHSQT3	\$ 21.08	1
	Black Flashing Square 0-35mm	FLASHSQT4	\$ 27.04	1
	Flashing No5 Black 100-200mm	FLASHSQT5	\$ 35.64	1
	Black Flashing Square 5-127mm	FLASHSQT6	\$ 49.27	1
Flashing No7 Black 150-300mm	FLASHSQT7	\$ 60.44	1	

DEKS TOP HAT ROOF KIT	Size	Code	Individual	
			\$/each	Qty
	DEKS TOP HAT ROOF KIT 65MM	FLASHKT65	\$ 156.24	1
	DEKS TOP HAT ROOF KIT 80MM	FLASHKT80	\$ 165.84	1



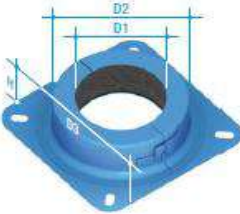

## FIRE PENETRATIONS

Retrofit Collars	Description	Code	Trade Pickup	Qty	Bulk \$/each	Qty Pkt	
	40mm Retrofit Collar-Flanged	FRFC40	\$ 66.31	1	\$ -	20	
	50mm Retrofit Collar-Flanged	FRFC50	\$ 68.18	1	\$ 68.18	20	
	65mm Retrofit Collar-Flanged	FRFC65	\$ 78.73	1	\$ -	15	
	80mm Retrofit Collar-Flanged	FRFC80	\$ 78.60	1	\$ -	20	
	100mm Retrofit Collar-Flanged	FRFC100	\$ 90.86	1	\$ -	10	
	150mm Retrofit Collar-Flanged	FRFC150	\$ 154.38	1	\$ 154.38	5	
	250mm Retrofit Collar-Flanged	FRFC250	POA		1	POA	1
	300mm Retrofit Collar-Flanged	FRFC300	POA		1	POA	2

Retrofit Collar (square base) is a multi-purpose collar designed for use with concrete slabs, masonry and lightweight walls and lined ceilings. They can be split open, enabling retrofitting as and when necessary

UniCollar & Conduit Collar	Description	Code	Trade Pickup	Qty	Bulk \$/each	Qty Pkt
	2250mm Unicollar Strips	FRFC2M	\$ 264.00	1	\$ -	-
	SINGLE Brackets	FRUCSB	POA	1	POA	24
	32mm Conduit Collar	FRCFC32	POA	1	POA	10

UC Unicollar is one of a new generation of fire collars designed to protect uPVC, HDPE, PP and other plastic pipes which pass through fire rated elements of building construction.

CFC Conduit Collars are designed for retrofitting around small (<32mm) plastic conduit pipes that pass through fire walls or floor slabs

Wall Collars	Description	Code	Trade Pickup	Qty	Bulk \$/each	Qty Pkt
	40mm Wall Collar	FRFCW40	POA		POA	20
	50mm Wall Collar	FRFCW50	\$ 53.68		\$ 50.33	12
	65mm Wall Collar	FRFCW65	\$ 56.12		\$ 52.61	20
	100mm Wall Collar	FRFCW100	\$ 81.31		\$ 76.22	10
	150mm Wall Collar	FRFCW150	POA		POA	4

Wall Collars is designed for insertion into wall elements made of calcium silicate, plasterboard, concrete or masonry. This is a split type collar enabling retro fitting where necessary.

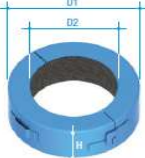
Drop-in Collars	Description	Code	Trade Pickup	Qty	Bulk \$/each	Qty Pkt
	50mm Drop-in Collar	FRFCD50	POA		POA	30
	100mm Drop-in Collar	FRFCD100	POA		POA	20

Drop-in Collars are for insertion into cored holes from the top of the slab.

## FIRE PENETRATIONS

Cast-in Collars	Description	Code	Trade Pickup	Qty	Bulk \$/each	Qty Pkt
	40-65mm Hi-Blu Collar	FRHI-BLU65	POA	1	POA	6
	80-110mm Hi-Blu Collar	FRHI-BLU100	POA	1	POA	6
	150mm Hi-Blu Collar	FRHI-BLU150	POA	1	POA	2

Hi-Blu Collars are designed to be fixed to formwork prior to pouring of concrete floor slabs.

Cast-in Collars	Description	Code	Trade Pickup	Qty	Bulk \$/each	Qty Pkt
	40mm Green Cast-in Collar	FRGREEN40	POA	1	POA	10
	50mm Green Cast-in Collar	FRGREEN50	POA	1	POA	10
	65mm Green Cast-in Collar	FRGREEN65	POA	1	POA	10
	80mm Green Cast-in Collar	FRGREEN80	POA	1	POA	10
	100mm Green Cast-in Collar	FRGREEN100	POA	1	POA	10

HGreen Cast-in Collars are designed to be fixed to formwork prior to pouring of concrete floor slabs. The collar accommodates the uPVC pipe fitting inside the soffit of the slab, enabling significant space savings to be achieved. Green Cast-in Collars will close both pipe and pipe fitting in the event of fire

Mortar	Description	Code	Trade Pickup	Qty	Bulk \$/each	Qty Pkt
	20KG Mortar	FRFMF20	\$ 163.52	1	\$ -	30



Fireban 1	Description	Code	Trade Pickup	Qty	Bulk \$/each	Qty Pkt
	Fireban 1 Limestone Sausage 870gm	SILFRBAN	\$ 26.34	1	\$ 23.41	-

Grafitex	Description	Code	Trade Pickup	Qty	Bulk \$/each	Qty Pkt
	Intumescent Compound Grafitex 4ltr	SILFRGR	\$ 438.86	1	\$ 406.35	-

FlexiWrap	Description	Code	Trade Pickup	Qty	Bulk \$/each	Qty Pkt
	FlexiWrap - Intumedcent Wrap	SILFRFXW	\$ 232.50	1	\$ 232.50	5



## FIRE PENETRATIONS



Non-Fire Rated Backing Rod	Description	Code	Trade Pickup	Qty	Bulk \$/each	Qty Pkt
	16mm Foam Rod/Strip	FRBR16	POA	1	POA	150m
	22mm Foam Rod/Strip	FRBR22	POA	1	POA	100m
	29mm Foam Rod/Strip	FRBR29	POA	1	POA	60m
	38mm Foam Rod/Strip	FRBR38	POA	1	POA	30m
	50mm Foam Rod/Strip	FRBR50	POA	1	POA	30m

High Performance Retrofit Collars	Description	Code	Trade Pickup	Qty	Bulk \$/each	Qty Pkt
	Maxi Pipe Collar - 32mm	SILFRMP32	POA	1	POA	1
	Maxi Pipe Collar - 40mm	SILFRMP40	POA	1	POA	1
	Maxi Pipe Collar - 50mm	SILFRMP50	POA	1	POA	1
	Maxi Pipe Collar - 65mm	SILFRMP65	POA	1	POA	1
	Maxi Pipe Collar - 75mm	SILFRMP75	POA	1	POA	1
	Maxi Pipe Collar - 80mm	SILFRMP80	POA	1	POA	1
	Maxi Pipe Collar - 100mm	SILFRMP100	POA	1	POA	1
	Maxi Pipe Collar - 125mm	SILFRMP125	POA	1	POA	1
	Maxi Pipe Collar - 150mm	SILFRMP150	POA	1	POA	1
	Maxi Pipe Collar - 200mm	SILFRMP200	POA	1	POA	1
	Maxi Pipe Collar - 250mm	SILFRMP250	POA	1	POA	1

FyreBox™ Multi-Service Cable & Pipe Transit	Description	Code	Trade Pickup	Qty	Bulk \$/each	Qty Pkt
	Fyrebox 150x150mm 2hr	SILFRFB150	POA	1	POA	10
	Fyrebox 300x150mm 2hr	SILFRFB300	POA	1	POA	10

Fire Pillows	Description	Code	Trade Pickup	Qty	Bulk \$/each	Qty Pkt
	200x100x40mm Fire Pillows	SILFRFP1	\$13.37	1	\$0.00	10
	200x200x40mm Fire Pillows	SILFRFP2	\$15.93	1	\$0.00	10
	300x200x40mm Fire Pillows	SILFRFP3	\$16.80	1	\$0.00	10

## FIRE PENETRATIONS

Fire Mastics	Description	Code	Trade Pickup	Qty	Bulk \$/each	Qty Pkt
 	300ml Caulk - FireMastic-300 Orange	SILFRM300	\$22.50	1	\$ 22.50	12
	600ml Sausage - FireMastic-Grey	SILFRM600	\$ 17.67	1	\$ 15.91	12
	600ml Sausage - FireMastic-White	SILFRM600W	\$16.00	1	\$ -	12
	FIREMASTIC - HPE 300ml CARTRIDGE Green	SILFRHP	\$ 47.60	1	\$ -	12
	FIREMASTIC - HPE 600ml Sausage Green	SILFRHP600	\$78.30	1	\$ -	12

Intumescent Fire Dampers	Description	Code	Trade Pickup	Qty	Bulk \$/each	Qty Pkt
	100mm Circular dampers	SILFRHT100	\$120.00	1	\$ -	5
	150mm Circular dampers	SILFRHT150	\$ 157.50	1	\$ -	5
	200mm Circular dampers	SILFRHT200	\$232.73	1	\$ 232.73	5
	250mm Circular dampers	SILFRHT250	POA	1	POA	5
	300mm Circular dampers	SILFRHT300	\$742.50	1	\$ -	5
	400mm Circular dampers	SILFRHT400	POA	1	POA	5
	450mm Circular dampers	SILFRHT450	POA	1	POA	5
	300x300mm Intumescent Damper	SILFRHTS300	\$ 215.00		\$ -	

Intumescent Fire Dampers	Description	Code	Trade Pickup	Qty	Bulk \$/each	Qty Pkt
	100mm Square dampers	SILFRHQ100	POA	1	POA	5
	150mm Square dampers	SILFRHQ150	POA	1	POA	5
	200mm Square dampers	SILFRHQ200	POA	1	POA	5
	250mm Square dampers	SILFRHQ250	POA	1	POA	5
	300mm Square dampers	SILFRHQ300	POA	1	POA	5
	400mm Square dampers	SILFRHQ400	POA	1	POA	5
	500mm Square dampers	SILFRHQ500	POA	1	POA	5
	600mm Square dampers	SILFRHQ600	POA	1	POA	5
	Custom*	SILFRHQMIS	POA	1	POA	5

## Pipe Support & Brackets





## PIPE FASTENERS TO SUIT COPPER PIPE

Clip Heads	Nominal Size	Imperial Size	Powder Coated		Stainless Steel		Qty Pkt
			Code	\$/each	Code	\$/each	
	15	1/2"	CCH050	\$1.02	CCH050S	\$4.62	20
	18	5/8"	CCH062	\$1.64	CCH062S	\$7.27	20
	20	3/4"	CCH075	\$1.02	CCH075S	\$5.02	20
	25	1"	CCH100	\$1.08	CCH100S	\$5.34	20
	32	1 1/4"	CCH125	\$1.60	CCH125S	\$5.82	20
	40	1 1/2"	CCH150	\$1.72	CCH150S	\$5.83	20
	50	2"	CCH200	\$1.84	CCH200S	\$6.82	20
	65	2 1/2"	CCH250	\$2.73	CCH250S	\$11.44	20
	80	3"	CCH300	\$2.97	CCH300S	\$9.79	20
	100	4"	CCH400	\$5.17	CCH400S	\$10.52	20
	125	5"	CCH500	\$5.75	CCH500S	\$13.75	20
	150	6"	CCH600	\$7.42	CCH600S	\$12.36	20

Hinged Welded Nut Hanger	Nom. Size	Imp. Size	Acoustic Lined		Stainless Steel		Qty Pkt
			Code	\$/each	Code	\$/each	
	15	1/2"	CWA050	\$0.00			
	20	3/4"	CWA075	\$2.02	CWA075S	POA	100
	25	1"	CWA100	\$2.20	CWA100S	POA	100
	32	1 1/4"	CWA125	\$2.58	CWA125S	POA	100
	40	1 1/2"	CWA150	\$2.69	CWA150S	POA	100
	50	2"	CWA200	\$2.87	CWA200S	POA	50
	65	2 1/2"	CWA250	\$3.52			
	80	3"	CWA300	\$3.52	CWA300S	POA	25
	100	4"	CWA400	\$6.38	CWA400S	POA	25

Welded Nut Hanger	Nom. Size	Imp. Size	Acoustic Lined		Stainless Steel		Qty Pkt
			Code	\$/each	Code	\$/each	
	15	1/2"	CWH050	\$1.96	CWH050S	\$19.02	100
	20	3/4"	CWH075	\$1.28	CWH075S	\$19.02	100
	25	1"	CWH100	\$1.36	CWH100S	\$19.23	100
	32	1 1/4"	CWH125	\$1.61	CWH125S	\$19.30	100
	40	1 1/2"	CWH150	\$1.74	CWH150S	\$19.45	100
	50	2"	CWH200	\$1.89	CWH200S	\$19.58	50
	65	2 1/2"	CWH250	\$3.52	CWH250S	\$19.70	50
	80	3"	CWH300	\$2.88	CWH300S	\$19.98	25
	100	4"	CWH400	\$3.36	CWH400S	\$22.29	25
	125	5"	CWH500	\$11.68	CWH500S	\$34.55	1
	150	6"	CWH600	\$14.19	CWH600S	\$40.31	1

Brown Welded Nut Hanger	Nom. Size	Imp. Size	Acoustic Lined		Qty Pkt
			Code	\$/each	
	15	1/2"	CWH050P	\$1.76	
	20	3/4"	CWH075P	\$1.81	
	32	1 1/4"	CWH125P	\$2.05	
	50	2"	CWH200P	\$2.40	
	80	3"	CWH300P	\$2.81	

Ph: 02 9525 0970

Fax: 02 9540 2899

Email: orders@arrowsales.com.au



## PIPE FASTENERS TO SUIT COPPER PIPE

Copper Saddles	Nom. Size	Imp. Size	Light Pattern		Heavy Pattern		Qty Pkt
			Code	\$/100	Code	\$/100	
	6	1/4"	CSL025	\$30.23			100
	8	5/16"	CSL031	\$35.26			100
	10	3/8"	CSL037	\$38.79			100
	15	1/2"	CSL050	\$36.46	CSH050	\$54.00	100
	18	5/8"	CSL062	\$44.41	CSH062	\$65.00	100
	20	3/4"	CSL075	\$49.59	CSH075	\$76.00	100
	22	7/8"			CSH087	\$134.00	100
	25	1"	CSL100	\$103.99	CSH100	\$141.00	100
	32	1 1/4"			CSH125	\$197.00	20
	40	1 1/2"			CSH150	\$294.00	20
	45	1 3/4"			CSH175	\$389.00	20
	50	2"			CSH200	\$366.00	20
	65	2 1/2"			CSH250	\$1,277.00	1
	80	3"			CSH300	\$1,462.00	1
	100	4"			CSH400	\$1,664.00	1
125	5"			CSH500	\$2,624.00	1	
150	6"			CSH600	\$3,310.00	1	

Metric Round U Bolts	Description	Hot Dip Galvanised		Qty Pkt
		Code	\$/each	
	HDG U-BLT KIT 15NB: M10 x 21	UBOLT021	\$2.95	50
	HDG U-BLT KIT 20NB: M10 x 27	UBOLT027	\$3.16	50
	HDG U-BLT KIT 25NB: M10 x 34	UBOLT034	\$3.30	50
	HDG U-BLT KIT 32NB: M10 x 43	UBOLT043	\$3.56	50
	HDG U-BLT KIT 40NB: M10 x 48	UBOLT048	\$3.70	50
	HDG U-BLT KIT 40NB: M10 x 51	UBOLT051	\$3.83	50
	HDG U-BLT KIT 50NB: M10 x 60	UBOLT060	\$4.09	50
	HDG U-BLT KIT 65NB: M12 x 76	UBOLT076	\$6.33	25
	HDG U-BLT KIT 80NB: M12 x 89	UBOLT089	\$6.86	25
	HDG U-BLT KIT 90NB: M12 x 102	UBOLT102	\$8.45	25
	HDG U-BLT KIT 100NB: M12 x 114	UBOLT115	\$10.25	10
	HDG U-BLT KIT 125NB: M12 x 140	UBOLT140	\$11.06	10
	HDG U-BLT KIT 150NB: M12 x 165	UBOLT165	\$11.55	10
	HDG U-BLT KIT 150NB: M12 x 168	UBOLT168	\$12.37	10
	HDG U-BLT KIT 200NB: M16 x 219	UBOLT219	\$22.85	10
	HDG U-BLT KIT 250NB: M20 x 273	UBOLT273	\$56.70	10
	HDG U-BLT KIT 300NB: M20 x 324	UBOLT324	\$74.58	1
	HDG U-BLT KIT 350NB: M20 x 356	UBOLT356	\$82.77	1
	HDG U-BLT KIT 400NB: M20 x 406	UBOLT406	\$87.69	1
	HDG U-BLT KIT 450NB: M24 x 457	UBOLT457	\$113.89	1
HDG U-BLT KIT 500NB: M24 x 508	UBOLT508	\$126.99	1	
HDG U-BLT KIT 600NB: M24 x 610	UBOLT610	\$136.82	1	

Ph: 02 9525 0970

Fax: 02 9540 2899

Email: orders@arrowsales.com.au

Please Note All Prices Are GST Exclusive

## Pipe Fasteners to Suit Copper Pipe

Coated Saddles	Nom. Size	Imp. Size	Galvanised		Powder Coated		Hot Dip Gal		Qty Pkt
			Code	\$/100	Code	\$/100	Code	\$/100	
	6	1/4"			PCS025	\$20.56			100
	8	5/16"			PCS031	\$27.07			100
	10	3/8"			PCS037	\$18.56			100
	15	1/2"	GVS050	\$41.56	PCS050	\$16.56	GS050	\$29.98	200
	18	5/8"			PCS062	\$24.34	GS062	\$43.88	200
	20	3/4"			PCS075	\$23.07	GS075	\$45.94	200
	25	1"			PCS100	\$27.70	GS100	\$64.38	200
	32	1 1/4"	GVS125	\$60.29	PCS125	\$91.42	GS125	\$113.50	20
	40	1 1/2"			PCS150	\$115.08	GS150	\$129.58	20
	50	2"	GVS200	\$87.32	PCS200	\$130.96	GS200	\$179.40	20
	65	2 1/2"			PCS250	\$606.90	GS250	\$240.67	20

Plated Saddles	Nom. Size	Imp. Size	Chrome Plated		Zinc Plated		Black Zinc		Qty Pkt
			Code	\$/100	Code	\$/100	Code	\$/100	
	10	3/8"			ZPS037	\$25.86			100
	15	1/2"	CRS050	\$105.10	ZPS050	\$13.75	BS050	\$67.83	100
	18	5/8"			ZPS062	\$15.71			100
	20	3/4"	CRS075	\$171.44	ZPS075	\$19.56	BS075	\$55.11	100
	22	7/8"			ZPS087	\$53.99			100
	25	1"			ZPS100	\$30.36	BS100	\$94.43	100
	32	1 1/4"			ZPS125	\$61.27			20
	40	1 1/2"			ZPS150	\$79.29			20
	50	2"			ZPS200	\$93.08			20

Single Sided Saddles	Nom. Size	Imp. Size	Powder Coated		Zinc Plated		Qty Pkt
			Code	\$/100	Code	\$/100	
	5	3/16"			ZPC018	\$24.80	100
	6	1/4"			ZPC025	\$35.89	100
	8	5/16"			ZPC031	\$31.29	100
	10	3/8"			ZPC037	\$23.99	100
	15	1/2"	CCP050	\$51.33	ZPC050	\$17.31	100
	18	5/8"			ZPC062	\$19.06	100
	20	3/4"	CCP075	\$61.37	ZPC075	\$48.00	100
	25	1"	CCP100	\$117.05	ZPC100	\$54.00	100

Stand-Off Brackets	Nominal Size	Imperial Size	Stainless Steel		Qty Pkt
			Code	\$/each	
	15	1/2"	CSB050S	\$17.23	1
	20	3/4"	CSB075S	\$16.15	1
	25	1"	CSB100S	\$16.15	1
	32	1 1/4"	CSB125S	\$16.18	1
	40	1 1/2"	CSB150S	\$16.85	1
	50	2"	CSB200S	\$17.51	1
	65	2 1/2"	CSB250S	\$21.12	1
	80	3"	CSB300S	\$19.49	1
	100	4"	CSB400S	\$20.15	1
	125	5"	CSB500S	\$47.32	1
	150	6"	CSB600S	\$43.98	1

*\*Please note that these items are made to order with minimum quantities required*

Ph: 02 9525 0970

Fax: 02 9540 2899

Email: orders@arrowsales.com.au

## Pipe Fasteners to Suit PVC Pressure Pipe

Pressure Pipe Full Saddles	Nom. Size	Galvanised		Powder Coated		Qty Pkt
		Code	\$/each	Code	\$/each	
	15	GVS084	\$0.21	PPS084	\$1.08	100
	20	GVS106	\$0.26	PPS106	\$1.14	100
	25	GVS134	\$0.34	PPS134	\$0.74	100
	32	GVS168	\$0.59	PPS168	\$1.50	20
	40	GVS190	\$0.73	PPS190	\$1.10	20
	50	GVS237	\$0.88	PPS237	\$1.42	20

Pressure Pipe Stand-Off Brackets	Nom. Size	Powder Coated		Stainless Steel		Qty Pkt
		Code	\$/each	Code	\$/each	
	15	PPSB075	\$7.38	PPSB084S	\$15.41	1
	20	PPSB100	\$7.80	PPSB106S	\$15.77	1
	25	PPSB125	\$7.86	PPSB134S	\$16.01	1

Pressure Pipe Half Saddle	Nom. Size	Zinc Plated		Hot Dipped Galvanised		Qty Pkt
		Code	\$/each	Code	\$/each	
	15	CON020	\$0.23	CON020G	\$0.43	100
	20	CON025	\$0.28	CON025G	\$0.51	100
	25	CON032	\$0.67	CON032G	\$1.09	100
	32	CON040	\$0.90	CON040G	\$2.64	50

Pressure Pipe Weld Nut Clips	Nom. Size	Zinc Plated		Powder Coated		Qty Pkt
		Code	\$/each	Code	\$/each	
	15	BWH084	\$2.91	BWH084P	\$4.85	1
	20	BWH106	\$3.12	BWH106P	\$5.20	1
	25	BWH134	\$3.12	BWH134P	\$5.20	1
	32	BWH168	\$3.27	BWH168P	\$5.45	1
	40	BWH190	\$3.39	BWH190P	\$5.65	1
	50	BWH237	\$3.63	BWH237P	\$6.05	1
	65	BWH300	\$3.99	BWH300P	\$6.65	1
	80	BWH350	\$4.50	BWH350P	\$7.50	1
	100	BWH450	\$5.43	BWH450P	\$9.05	1
	150	BWH650	\$15.90	BWH650P	\$15.90	1

Pressure Pipe & Steel Pipe Clip Heads	Nom. Size	Powder Coated		Qty Pkt
		Code	\$/each	
	15	PCH084	\$2.47	20
	20	PCH106	\$1.90	20
	25	PCH134	\$1.89	20
	40	PCH190	\$2.17	20
	50	PCH237	\$2.72	20

*\*Please note that these items are made to order with minimum quantities required*

## Pipe Fasteners to Suit DWV & SWV PVC Pipe

Clip Heads	Nominal Size	Imperial Size	Powder Coated		Stainless Steel		Qty Pkt
			Code	\$/each	Code	\$/each	
	40	1 1/2"	PMC175	\$1.78	PMC175S	\$5.38	20
	50	2"	PMC225	\$1.80	PMC225S	\$3.97	20
	65	2 1/2"	PMC275	\$2.45	PMC275S	\$5.36	20
	80	3"	PMC325	\$2.63	PMC325S	\$5.76	20
	90	3 1/2"	PMC350	\$1.45	PMC350S	\$4.61	20
	100	4"	PMC437	\$2.40	PMC437S	\$5.53	20
	150	6"	PMC637	\$4.81	PMC637S	\$13.59	20

Strap Hangers - 300mm Tails	Nominal Size	Imperial Size	Powder Coated		Stainless Steel		Qty Pkt
			Code	\$/each	Code	\$/each	
	32	1 1/4"	PSH150	\$5.13	PSH150S	\$10.70	1
	40	1 1/2"	PSH175	\$3.70	PSH175S	\$10.10	1
	50	2"	PSH225	\$2.95	PSH225S	\$10.64	1
	65	2 1/2"	PSH275	\$3.87	PSH275S	\$12.27	1
	80	3"	PSH325	\$4.27	PSH325S	\$13.90	1
	90	3 1/2"	PSH350	\$4.97	PSH350S	\$14.12	1
	100	4"	PSH437	\$3.36	PSH437S	\$14.41	1

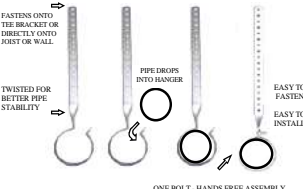
Hanging Brackets - 450mm Tails	Nominal Size	Imperial Size	Galvanised		Stainless Steel		Qty Pkt
			Code	\$/each	Code	\$/each	
	40	1 1/2"	PHB175	\$4.08	PHB175S	\$13.08	1
	50	2"	PHB225	\$4.08	PHB225S	\$13.08	1
	65	2 1/2"	PHB275	\$4.80	PHB275S	\$14.41	1
	80	3"	PHB325	\$5.25	PHB325S	\$15.76	1
	90	3 1/2"	PHB350	\$5.05	PHB350S	\$16.20	1
	100	4"	PHB437	\$5.11	PHB437S	\$16.41	1

Saddles	Nom. Size	Imp. Size	Powder Coated		Stainless Steel		Qty Pkt
			Code	\$/each	Code	\$/each	
	150	6"	PVS637	\$6.47	SSS637	\$30.79	1
	225	9"	PVS985	\$29.59	SSS986	\$82.97	1
	300	12"	PVS1275	\$44.62	SSS1240	\$144.21	1
	375	15"	PVS1575	\$57.99	SSS1575	\$173.93	1

Short Saddles for DWV Pipe	Nom. Size	Imp. Size	Powder Coated		Stainless Steel		Qty Pkt
			Code	\$/100	Code	\$/each	
	40	1 1/2"	PS175	\$0.78	PS175S	\$1.85	100
	50	2"	PS225	\$0.82	PS225S	\$2.31	100
	65	2 1/2"	PS275	\$1.15	PS275S	\$4.82	100
	80	3"	PS325	\$1.11	PS325S	\$4.82	100
	90	3 1/2"	PS350	\$1.30	PS350S	\$4.18	50
	90	3 1/2"	PS350H	\$2.74	HEAVY	POA	50
	100	4"	PS437	\$1.55	SSS437	\$12.59	50

\*Please note that these items are made to order with minimum quantities required

Ph: 02 9525 0970

Fax: 02 9540 2899

Email: orders@arrowsales.com.au

## Pipe Fasteners to Suit DWV & SWV PVC Pipe

Stand-Off Saddles For DWV Pipe	Nom. Size	Imp. Size	Powder Coated		Stainless Steel		Qty Pkt
			Code	\$/100	Code	\$/each	
	40	1 1/2"	PSS175	\$90.05	PSS175S	\$1.99	100
	50	2"	PSS225	\$87.43	PSS225S	\$2.61	100
	65	2 1/2"	PSS275	\$139.45			100
	80	3"	PSS325	\$168.87			100
	90	3 1/2"	PSS350	\$163.95	PSS350S	\$4.33	100
	90	3 1/2"	PSS350H	\$273.94	HEAVY		50
	100	4"	PSS437	\$222.29	PSS437S	\$6.29	50

Stand-Off Brackets	Nom. Qty	Imp. Size	Powder Coated		Stainless Steel		Qty Pkt
			Code	\$/each	Code	\$/each	
25mm to 150mm    225mm to 375mm	40	1 1/2"			PSB175S	\$15.67	1
	50	2"	PSB225	\$4.89	PSB225S	\$14.32	1
	65	2 1/2"			PSB275S	\$15.90	1
	80	3"			PSB325S	\$16.56	1
	100	4"	PSB437	\$4.12	PSB437S	\$16.15	1
	150	6"	PSB637	\$9.85	PSB637S	\$35.13	1
	225	9"	PSB985	\$47.32	PSB985S	\$158.11	1
	300	12"	PSB1240	\$63.89	PSB1240S	\$143.08	1
	375	15"	PSB1475	\$75.78	PSB1575S	\$172.24	1

Adjustable Hangers	Nom. Size	Imp. Size	Galvanised Code	Powder Coated		Stainless Steel		Qty Pkt	
				\$/each	Code	\$/each	Code		
	100	4"	PAH437G	\$12.23	PAH437	\$9.79	PAH437S	\$29.36	1
	150	6"	PAH637G	\$16.48	PAH637	\$13.18	PAH637S	\$39.95	1
	225	9"	PAH985G	\$63.01	PAH985	\$60.01	PAH985S	\$189.03	1
	300	12"	PAH1240G	\$76.42	PAH1240	\$69.43	PAH1240S	\$208.28	1
	375	15"	PAH1575G	\$84.07	PAH1575	\$76.42	PAH1575S	POA	1

Pear Shaped Hangers	Nom. Size	Imp. Size	Galvanised Code	Powder Coated		Stainless Steel		Qty Pkt	
				\$/each	Code	\$/each	Code		
	20	3/4"	FBPH106V	\$1.39				100	
	25	1"	FBPH134V	\$0.93				100	
	32	1 1/4"	FBPH168V	\$1.05				100	
	40	1 1/2"	FBPH190V	\$1.12				100	
	50	2"	FBPH237V	\$1.51	PPH225	\$3.26	PPH225S	\$15.14	100
	65	2 1/2"	FBPH300V	\$2.08				60	
	80	3"	FBPH350V	\$2.70				60	
	100	4"	FBPH450V	\$3.30	PPH437	\$3.63	PPH437S	\$15.36	50
	150	6"	FBPH650V	\$6.76	PPH637	\$6.07	PPH637S	\$34.66	25
	225	9"	FBPH862V	\$28.35	PPH985	\$34.49	PPH985S	\$112.85	1
	300	12"			PPH1240	\$49.30	PPH1240S	\$180.38	1
	375	15"			PPH1475	\$59.69	PPH1575S	\$209.45	1

\*Please note that these items are made to order with minimum quantities required

Ph: 02 9525 0970

Fax: 02 9540 2899

Email: orders@arrowsales.com.au

Please Note All Prices Are GST Exclusive



## Pipe Fasteners to Suit PVC Pipe

Welded Nut Hangers	Nom. Size	Imp. Size	Zinc Plated		Powder Coated		Stainless Steel		Qty Pkt
			Code	\$/each	Code	\$/each	Code	\$/each	
	25	1"	BWH134	\$3.12	PWH132P	\$5.73	PWH132S	\$21.68	100
	32	1 1/4"	CWH125	\$1.61	PWH150P	\$5.16	PWH150S	\$21.85	100
	40	1 1/2"	PWH175	\$2.35	PWH175P	\$3.08	PWH175S	\$22.00	100
	50	2"	PWH225	\$2.66	PWH225P	\$3.16	PWH225S	\$22.14	100
	65	2 1/2"	PWH275	\$2.47	PWH275P	\$3.40	PWH275S	\$22.46	25
	80	3"	PWH325	\$3.25	PWH325P	\$4.16	PWH325S	\$23.29	25
	100	4"	PWH437	\$4.40	PWH437P	\$5.00	PWH437S	\$29.42	25
	150	6"	PWH637	\$7.50	PWH637P	\$6.32	PWH637S	\$42.37	25

Acoustic Nut Hangers	Nom. Size	Rubber Lined		Qty Pkt
		Code	\$/each	
	50	PWA225	\$2.97	100
	65	PWA275	\$3.51	50
	80	PWA325	\$3.98	50
	100	PWA437	\$6.68	50
	150	PWA637	\$4.12	50

*\*Please note that these items are made to order with minimum quantities required*

Strut Nut (M10 Thread)	Nom. Size	Code	\$/Each	Qty Pkt
	12-16	PRPE012	\$2.73	10
	17-20	PRPE017	\$2.73	10
	21-24	PRPE021	\$2.73	10
	25-29	PRPE025	\$3.45	10
	30-34	PRPE030	\$2.73	10
	35-40	PRPE035	\$3.82	10
	40-44	PRPE040	\$3.94	10
	48-54	PRPE048	\$4.24	10
	56-63	PRPE056	\$5.03	10
	66-76	PRPE066	\$5.27	10
	79-93	PRPE079	\$10.17	10
	101-115	PRPE0101	POA	10
	Spacer Snap	PRPE0SpC	\$1.64	10
	Strut Nut	PRPE0STNUT	\$1.45	10

**NEW**





## Pipe Fasteners to Suit Steel Pipe (BSP)

Adjustable Hangers	Nom. Size	Imp. Size	Powder Coated		Hot Dipped Gal.		Qty Pkt
			Code	\$/each	Code	\$/each	
	50	2"	BAH237	\$24.38	BAH237G	\$24.38	1
	65	2 1/2"	BAH300	\$24.38	BAH300G	\$24.38	1
	80	3"	BAH350	\$27.82	BAH350G	\$27.82	1
	100	4"	BAH450	\$34.97	BAH450G	\$34.97	1
	150	6"	BAH650	\$44.26	BAH650G	\$44.26	1
	200	8"	BAH862	\$54.21	BAH862G	\$54.21	1

Heavy Duty Bolted Hangers	Nom. Size	Imp. Size	Black (Raw)		Hot Dipped Gal.		Qty Pkt
			Code	\$/each	Code	\$/each	
	15	1/2"	HBH084	\$5.25	HBH084G	\$7.04	1
	20	3/4"	HBH106	\$5.37	HBH106G	\$7.37	1
	25	1"	HBH134	\$5.69	HBH134G	\$8.11	1
	32	1 1/4"	HBH168	\$5.99	HBH168G	\$8.70	1
	40	1 1/2"	HBH190	\$9.31	HBH190G	\$12.70	1
	50	2"	HBH237	\$9.45	HBH237G	\$12.95	1
	65	2 1/2"	HBH300	\$10.60	HBH300G	\$14.80	1
	80	3"	HBH350	\$11.69	HBH350G	\$15.76	1
	90	3 1/2"	HBH375	\$16.45	HBH375G	\$20.73	1
	100	4"	HBH450	\$14.02	HBH450G	\$20.74	1
	125	5"	HBH550	\$19.86	HBH550G	\$32.41	1
	150	6"	HBH650	\$22.20	HBH650G	\$32.71	1
	178	7"	HBH700	\$38.54	HBH700G	\$40.93	1
	200	8"	HBH862	\$55.93	HBH862G	\$82.17	1
	225	9"	HBH985	\$61.52	HBH985G	\$97.49	1
	250	10"	HBH1075	\$61.52	HBH1075G	\$90.53	1
300	12"	HBH1275	\$68.64	HBH1275G	\$97.49	1	

Saddles (Heavy - 40 x 6)	Nom. Size	Imp. Size	Hot Dipped Gal.		Qty Pkt
			Code	\$/each	
	90	3 1/2"	GS400H	\$24.92	1
	114	4"	GS450H	\$23.63	1
	140	5"	GS600H	\$31.14	1
	168	6"	GS650H	\$25.50	1

*\*Please note that these items are made to order with minimum quantities required*

## Pipe Fasteners to Suit Steel Pipe (BSP)

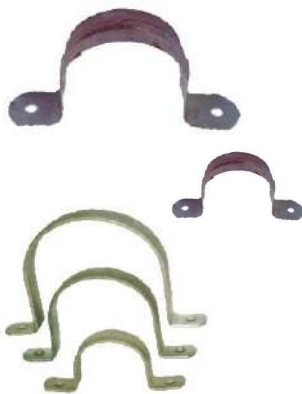
Saddles	Nom. Size	Imp. Size	Galvanised		Hot Dipped Gal.		Stainless Steel		Qty Pkt
			Code	\$/each	Code	\$/each	Code	\$/each	
	15	1/2"	GVS084	\$0.21	GS084	\$0.25	GS084S	\$2.01	100
	20	3/4"	GVS106	\$0.26	GS106	\$0.32	GS106S	\$2.29	100
	25	1"	GVS134	\$0.34	GS134	\$0.47	GS134S	\$2.93	100
	32	1 1/4"	GVS168	\$0.59	GS168	\$0.76	GS168S	\$4.00	50
	40	1 1/2"	GVS190	\$0.73	GS190	\$0.85	GS190S	\$5.09	50
	50	2"	GVS237	\$0.88	GS237	\$1.10	GS237S	\$5.89	50
	50	2"	HEAVY VERSION		GS280	\$4.12			1
	65	2 1/2"			GS315	\$5.51	GS315S	\$20.44	1
	80	3"			GS350	\$5.92	GS350S	\$21.70	1
	100	4"			GS450	\$7.43	GS450S	\$25.48	1
	125	5"			GS550	\$12.68	GS550S	\$29.64	1
	150	6"			GS650	\$9.43	GS650S	\$29.64	1
	203	8"			GS800	\$35.35			1
	220	8"			GS862	\$36.92	GS862S	\$100.24	1
	250	10"			GS1075	\$45.10	GS1075S	\$90.44	1
	300	12"			GS1275	\$61.71	GS1275S	\$133.83	1
	350	14"			GS1400	\$67.99	GS1400S	\$177.24	1

\*Please note that these items are made to order with minimum quantities required

Studding M10 Clip	Imp Size	Code	Price	Qty
	10	PRPS038	\$3.24	10
	15	PRPS058	\$3.30	10
	20	PRPS034	\$3.48	10
	22	PRPS078	\$3.48	10
	24-26	PRPS100	POA	10
	28	PRPS118	\$3.60	10
	32	PRPS114	\$3.84	10
	34-37	PRPS135	POA	10
	35	PRPS138	\$3.96	10
	44-48	PRPS168	POA	10
	50-54	PRPS200	POA	10
	56-60	PRPS220	POA	10
	62-66	PRPS250	POA	10

\*Please note that these items are made to order with minimum quantities required



## Stainless Steel Pipe Fasteners

Multi-Way Saddles	Stainless Steel 304 Grade		Price	Qty Pkt
	Size	Code	\$/100	
	6.4mm x 1 Way	MCS025-1S	\$55.60	100
	8mm x 1 Way	MCS031-1S	\$70.17	100
	8mm x 2 Way	MCS031-2S	\$98.11	100
	8mm x 3 Way	MCS031-3S	\$100.19	100
	8mm x 4 Way	MCS031-4S	\$100.54	100
	10mm x 1 Way	MCS039-1S	\$57.55	100
	10mm x 2 Way	MCS039-2S	\$98.93	100
	10mm x 3 Way	MCS039-3S	\$119.23	100
	10mm x 4 Way	MCS039-4S	\$126.26	100
	12.7mm x 1 Way	MCS050-1S	\$74.90	100
	12.7mm x 2 Way	MCS050-2S	\$116.31	100
	12.7mm x 3 Way	MCS050-3S	\$127.93	100
	12.7mm x 4 Way	MCS050-4S	\$135.78	100
	14.3mm x 1 Way	MCS062-1S	\$100.92	100
	14.3mm x 2 Way	MCS062-2S	\$124.60	100
	14.3mm x 3 Way	MCS062-3S	\$138.67	100
	14.3mm x 4 Way	MCS062-4S	\$151.52	100
17.5mm x 1 Way	MSC069-1S	\$167.61	100	

Stainless Steel Saddles								
Nom. Size	Imp. Size	For PVC Pipe		For Copper Pipe		For Suit Steel Pipe		Qty Pkt
		Code	\$/each	Code	\$/each	Code	\$/each	
6	1/4"			SSS025	\$0.71			100
8	5/16"			SSS031	\$0.90			100
10	3/8"			SSS037	\$0.97			100
15	1/2"			SSS050	\$0.76	GS084S	\$2.01	100
18	5/8"			SSS062	\$1.64			100
20	3/4"			SSS075	\$1.21	GS106S	\$2.29	100
25	1"			SSS100	\$1.41	GS134S	\$2.93	100
32	1 1/4"			SSS125	\$2.32	GS168S	\$4.00	20
40	1 1/2"			SSS150	\$3.81	GS190S	\$5.09	20
50	2"			SSS200	\$4.30	GS237S	\$5.89	20
65	2 1/2"			SSS250	\$20.21			1
80	3"			SSS300	\$18.12			1
100	4"			SSS400	\$16.86			1
150	6"	SSS637	\$30.79					1
225	9"	SSS986	\$82.97					1



*\*Please note that these items are made to order with minimum quantities required*

## Stainless Steel Pipe Fasteners

Stand-Off Tees			
Nom. Size	Stainless Steel		Qty Pkt
	Code	\$/each	
25 x 1	SOTS	\$6.31	1



DWV & SWV Short Saddles				
Nom. Size	Imp. Size	For PVC Pipe		Qty Pkt
		Code	\$/each	
40	1 1/2"	PS175S	\$1.85	100
50	2"	PS225S	\$2.31	100
65	2 1/2"	PS275S	\$4.82	50
80	3"	PS325S	\$4.82	50
90	3 1/2"	PS350S	\$4.18	50
100	4"	PS437S	\$3.95	50

DWV & SWV Stand-Off Saddles				
Nom. Size	Imp. Size	For PVC Pipe		Qty Pkt
		Code	\$/each	
40	1 1/2"	PSS175S	\$1.99	100
50	2"	PSS225S	\$2.61	100
90	3 1/2"	PSS350S	\$4.33	50
100	4"	PSS437S	\$6.29	50



Stainless Steel Clip Heads	Nom. Size	Imp. Size	For PVC Pipe		For Cu Pipe		For Pressure Pipe		Qty Pkt
			Code	\$/each	Code	\$/each	Code	\$/each	
	15	1/2"			CCH050S	4.62	PCH084S	\$4.87	20
	18	5/8"			CCH062S	7.27			20
	20	3/4"			CCH075S	5.02	PCH106S	\$4.97	20
	25	1"			CCH100S	5.34	PCH134S	\$5.41	20
	32	1 1/4"			CCH125S	5.82	PCH168S	\$6.58	20
	40	1 1/2"	PMC175S	\$5.38	CCH150S	5.83	PCH190S	\$6.74	20
	50	2"	PMC225S	\$3.97	CCH200S	6.82	PCH237S	\$6.97	20
	65	2 1/2"	PMC275S	\$5.36	CCH250S	11.44			20
	80	3"	PMC325S	\$5.76	CCH300S	9.79			20
	90	3 1/2"	PMC350S	\$4.61					20
	100	4"	PMC437S	\$5.53	CCH400S	10.52			20
	150	6"	PMC637S	\$13.59	CCH600S	12.36			20

Stand-Off Brackets	Nom. Size	Imp. Size	For PVC Pipe		For Cu Pipe		Qty Pkt
			Code	\$/each	Code:	\$/each	
	15	1/2"			CSB050S	\$17.23	1
	20	3/4"			CSB075S	\$16.15	1
	25	1"	PSB132S	\$16.37	CSB100S	\$16.15	1
	32	1 1/4"	PSB150S	\$15.67	CSB125S	\$16.18	1
	40	1 1/2"	PSB175S	\$15.67	CSB150S	\$16.85	1
	50	2"	PSB225S	\$14.32	CSB200S	\$17.51	1
	65	2 1/2"	PSB275S	\$15.90	CSB250S	\$21.12	1
	80	3"	PSB325S	\$16.56	CSB300S	\$19.49	1
	100	4"	PSB437S	\$16.15	CSB400S	\$20.15	1
	150	6"	PSB637S	\$35.13	CSB600S	\$43.98	1
	225	9"	PSB985S	\$158.11			1
	300	12"	PSB1240S	\$143.08			1
	375	15"	PSB1575S	\$172.24			1

\*Please note that these items are made to order with minimum quantities required

Ph: 02 9525 0970

Fax: 02 9540 2899

Email: orders@arrowsales.com.au

## Pipe Fasteners Support Accessories

Stand-Off Tees	Galvanised		Stainless Steel		Powder Coated		Qty Pkt
	Code	\$/each	Code	\$/each	Code	\$/each	
	SOTG	\$0.92	SOTS	\$6.31	SOTP	\$5.02	



Adjustable Tees	Galvanised		QTY
	Code	\$/each	
	SOTA	\$0.92	



Offset Hangers	Galvanised		Stainless Steel		Hot Dipped Gal		Qty Pkt
	Code	\$/each	Code	\$/each	Code	\$/each	
	OHL25	\$2.78	OHL25S	\$11.12	OHL25G	\$3.88	

25mm x 3mm



\*Also available M10 Offset Hanger (10kg)

Code	\$/each	Qty Pkt
OHLM10	\$2.13	1

Internal Threaded Hanger	Nom. Size	Imp. Size	Galvanised		Qty Pkt
			Code	\$/each	
	M10	-	TW10M	\$1.61	50



Twist Strap	Nom. Size	Imp. Size	Galvanised		Stainless Steel		Qty Pkt
			Code	\$/each	Code	\$/each	
	300	12"	TS300	\$1.30	TS300S	\$12.38	50
450	18	TS450	\$3.92	TS450S	\$20.44	50	
600	24	TS600	\$4.51	TS600S	\$17.87	50	



Steel Strapping	Size	Galvanised		Stainless Steel		Qty Pkt
		Code	\$/each	Code	\$/each	
	23x0.4x15m	FS7415M	POA	FS715S	\$226.00	1
25x0.7x15m	FS715M	\$30.88	FS715S	\$226.00	1	
25x0.7x30m	FS730M	POA			1	



Blue Strapping	Size	Code	\$/each	Qty
	25mm x 50m	FS	POA	1



## Mechanical & Industrial Services

### Channel Section - 1000 Series

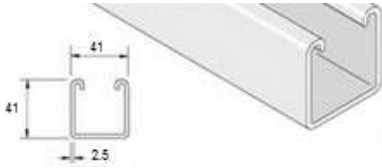

41x41 - Back on Back HDG - PLAIN  
 41x41x2.5 - Hot Dipped Galvanised - PLAIN  
 41x41x2.5 - Hot Dipped Galvanised - PLAIN

41x41x2.5 - Hot Dipped Galvanised - SLOTTED  
 41x41x2.5 - Pre-Galvanised - PLAIN  
 41x41x2.5 - Pre-Galvanised - PLAIN  
 41x41x2.5 - Pre-Galvanised - SLOTTED  
 41x41x2.5 - Pre-Galvanised - SLOTTED  
 41x41x2.5 - Stainless Steel 316 - PLAIN

Length m	Code	Channel Section Per Length	
		Trade Delivered Each*	Bulk Pick - Up Each*
6	C1001GP	\$283.48	\$253.11
3	C100GP3	\$83.74	\$64.13
6	C100GP6	\$140.00	\$124.00
3	C100GS3	\$76.81	\$68.81
6	C100GS6	\$133.62	\$117.62
3	C100P3	\$74.15	\$74.15
6	C100P6	\$114.04	\$95.04
3	C100S3	\$70.84	\$56.84
6	C100S6	\$121.68	\$105.68
6	C100SS316	\$707.24	\$589.37

### Channel Section - 2000 Series

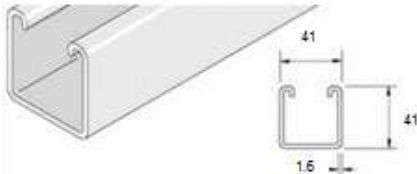

41x41x1.5 - Pre-Galvanised - PLAIN  
 41x41x1.6 - Pre-Galvanised - SLOTTED  
 41x41x1.6 - Pre-Galvanised - SLOTTED

Length m	Code	Channel Section Per Length	
		Trade Delivered Each*	Bulk Pick - Up Each*
6	C200P6	\$96.02	\$75.29
3	C200S3	\$40.95	\$40.95
6	C200S6	\$92.08	\$71.71

### Channel Section - 3000 Series



41x21x2.5 - Hot Dipped Galvanised - PLAIN  
 41x21x2.5 - Hot Dipped Galvanised - SLOTTED  
 41x21x2.5 - Hot Dipped Galvanised - SLOTTED  
 41x21x2.5 - Pre-Galvanised - SLOTTED  
 41x21x2.5 - Pre-Galvanised - SLOTTED  
 41x21x2.5 - Stainless Steel 316 - PLAIN

Length m	Code	Channel Section Per Length	
		Trade Delivered Each*	Bulk Pick - Up Each*
6	C330GP6	\$135.66	\$135.66
3	C330GS3	\$65.18	\$51.18
6	C330GS6	\$98.36	\$82.36
6	C330SS316	\$536.20	\$463.01

### Channel Section - 4000 Series



41x21x1.6 - Hot Dipped Galvanised - SLOTTED  
 41x21x1.6 - Pre-Galvanised - PLAIN  
 41x21x1.6 - Pre-Galvanised - SLOTTED  
 41x21x1.6 - Pre-Galvanised - SLOTTED

Length m	Code	Channel Section Per Length	
		Trade Delivered Each*	Bulk Pick - Up Each*
6	C400S6	\$78.58	\$55.38
6	C400P6	\$91.54	\$68.34
3	C400S3	\$51.10	\$27.90
6	C400S6	\$78.58	\$55.38

### Channel Section - 5000 Series

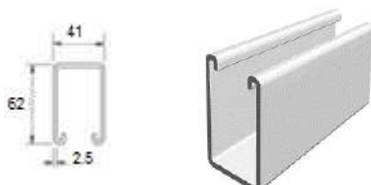

62x41x2.5 - Hot Dipped Galvanised - PLAIN

Length m	Code	Channel Section Per Length	
		Trade Delivered Each*	Bulk Pick - Up Each*
6	C500GP6	\$228.80	\$191.05

Ph: 02 9525 0970

Fax: 02 9540 2899

Email: orders@arrowsales.com.au



## Mechanical & Industrial Services

### Slotted Angle

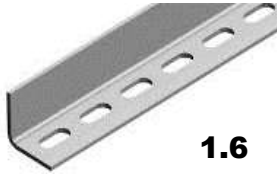

**1.6**

30x30x2.5 (11x18 hole)  
 30x30x2.5 (11x18 hole) HDG  
 50x50x4.5 (14x30 hole)  
 50x50x4.5 (14x30 hole) HDG

Length m	Code	Channel Section Per Length	
		Trade Delivered Each*	Bulk Pick - Up Each*
3	CASLT30	\$42.04	\$24.44
3	CASLT30G	\$50.36	\$32.76
3	CASLT50	\$91.83	\$74.23
3	CASLT50G	\$101.31	\$83.71

### Braced Cantilever Bracket



Length	Code	Per Bracket	
		Trade Delivered Mixed Each*	Bulk Pick - Up Mixed Each*
320	CAB320	\$29.34	\$24.34
470	CAB470	\$33.38	\$27.62
635	CAB635	\$42.12	\$34.24
780	CAB780	\$44.64	\$39.64



### Unbraced Cantilever Bracket

Length	Code	Per Bracket	
		Trade Delivered Mixed Each*	Bulk Pick - Up Mixed Each*
150	CA0150	\$19.28	\$17.90
200	CA0200	POA	POA
300	CA0300	\$20.66	\$15.62
450	CA0450	\$25.66	\$19.08
600	CA0600	\$31.24	\$25.22
700	CA0700	POA	POA
750	CA0750	\$34.48	\$29.38



### Back to Back Cantilever Bracket

Length	Code	Per Bracket	
		Trade Delivered Mixed Each*	Bulk Pick - Up Mixed Each*
300	CABB300	\$38.08	\$38.08
450	CABB450	\$72.10	\$72.10
600	CABB600	\$91.90	\$91.90
750	CABB750	\$103.10	\$103.10
900	CABB900	\$111.13	\$111.13

\*A minimum order surcharge applies for less than 5 lengths

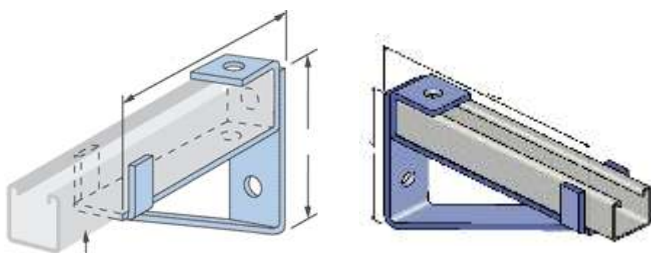

### Cantilever Bracket

Length	Code	Per Bracket	
		Trade Delivered Mixed Each*	Bulk Pick - Up Mixed Each*
121	CABM121	\$46.07	\$46.07
206	CABM206	\$55.33	\$55.33

Ph: 02 9525 0970

Fax: 02 9540 2899

Email: orders@arrowsales.com.au

## Mechanical & Industrial Services



Cantilever Assembly Packs for Airconditioning Mounting			
<b>CABASS1</b>	<b>Pack Includes</b> 4 x M10 Bolts, 4 x M10 Nuts, 4 x M10 Washers, 2 x Grey End CAPS	\$10.38	Set
<b>CABASS2</b>	<b>Pack Includes</b> 4 x M10 Bolts, 4 x M10 Nuts, 4 x M10 Washers, 2 x Grey End CAPS, 4 x 50mm Square Rubber Pads	\$19.90	Set



Channel Nuts - Hot Dipped Galvanised								
Details	Size	Short Spring		Long Spring		Plain		Qty Pkt
		Code	\$/each	Code	\$/each	Code	\$/each	
M6 Spring Nut	6	CNUT6SG	\$1.07	CNUT6LG	\$0.97	CNUT6PG	POA	100
M8 Spring Nut	8	CNUT8SG	\$1.07	CNUT8LG	\$1.07	CNUT8PG	POA	100
M10 Spring Nut	10	CNUT10SG	\$0.90	CNUT10LG	\$1.01	CNUT10PG	POA	100
M12 Spring Nut	12	CNUT12SG	\$1.07	CNUT12LG	\$1.07	CNUT12PG	POA	100







Channel Nuts - Zinc Plated								
Details	Size	Short Spring		Long Spring		Plain		Qty Pkt
		Code	\$/each	Code	\$/each	Code	\$/each	
M6 Spring Nut	6	CNUT6ST	\$1.07	CNUT6LZ	\$0.89	CNUT6NZ	\$0.92	100
M8 Spring Nut	8	CNUT8ST	\$1.07	CNUT8LZ	\$1.07	CNUT8NZ	\$1.07	100
M10 Spring Nut	10	CNUT10ST	\$0.90	CNUT10LZ	\$0.90	CNUT10NZ	\$0.90	100
M12 Spring Nut	12	CNUT12ST	\$1.07	CNUT12LZ	\$0.97	CNUT12NZ	\$1.08	100





Channel Nuts - Stainless Steel				
Details	Size	Long Spring		Qty Pkt
		Code	\$/each	
M6 Spring Nut	6	CNUT6LSS	\$6.62	100
M8 Spring Nut	8	CNUT8LSS	\$6.81	100
M10 Spring Nut	10	CNUT10LSS	POA	100
M12 Spring Nut	12	CNUT12LSS	\$8.03	100

## Mechanical & Industrial Services

Self Drilling Threaded Rod Hangers	Details	Code	\$/each	Qty Pkt
 	Concrete Vertigo 6mm (6.5mm x 32mm)	VVCH06	\$1.73	100
	Concrete Vertigo 10mm (6.5mm x 38mm)	VVCH10	\$2.74	100
	Steel Vertigo 6mm	VVSH06	\$1.76	100
	Steel Vertigo 8mm With Nuts	VVSH08	\$1.91	100
	Steel Vertigo 10mm With Nuts	VVSH10	\$2.42	100
	Steel Vertigo (Side) 6mm	VSSH06	\$2.50	100
	Steel Vertigo (Side) 8mm With Nuts	VSSH08	\$2.46	100
	Steel Vertigo (Side) 10mm With Nuts	VSSH10	\$2.92	100
	Steel Vertigo (Side) 12mm With Nuts	VSSH12	\$4.49	100
	Wood Vertigo 6mm (1/4 x 50 Type 17)	VVWH06	\$1.89	100
	Wood Vertigo 8mm (1/4 x 50 Type 17)	VVWH08	\$1.97	100
	Wood Vertigo 10mm (1/4 x 25 Type 17)	VVWH10	POA	100
	Wood Vertigo 10mm x 50mm	VVWH1050	\$2.23	100
	Wood Vertigo (Side) M10 (1/4 x 50 T17)	VSWH10	\$2.97	100
Universal (Metal/Wood) Socket (Red)	VUSOCK	\$20.44	100	

Purlin Clips	Details	Code	\$/each	Qty
 	M10 Lipped Purlin Hanger	PUR10	\$1.44	100
	M12 Lipped Purlin Hanger	PUR12	\$5.20	100
	M10 D Type Purlin Clip	PURD10	\$2.25	100
	M12 D TYPE Purlin Clip	PURD12	\$2.25	100
	M10 D Shape Purlin Hanger	PUR10	\$1.44	100
	M12 D Shape Purlin Hanger	PUR12	\$5.20	100

Wedge Nuts	Details	Code	\$/each	Qty
	M8 Zn Wedge Nut	WNUTM8	\$0.90	100
	M10 Zn Wedge Nut	WNUTM10	\$0.86	100
	M12 Zn Wedge Nut	WNUTM12	\$1.38	100

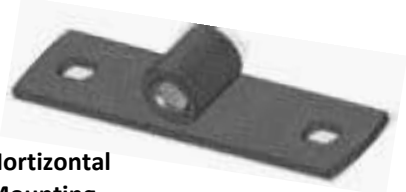
Mounting Plates	Details	Code	\$/each	Qty
  	M10 Zn Vertical Mounting Plate	MP10V	\$1.48	100
	M12 Zn Vertical Mounting Plate	MP12V	\$1.76	100
	M10 Zn Centre Mounting Plate	MP10C	\$1.48	100
	M12 Zn Centre Mounting Plate	MP12C	\$1.76	100
	M10 Zn Horizontal Mounting Plate	MP10H	\$1.48	100
	M12 Zn Horizontal Mounting Plate	MP12H	\$2.38	100

## Mechanical & Industrial Services

Beam Clamps	Details	Code	\$/each	Qty
	M10 - Clamping Beam Clamp	BEAMC	\$5.06	1
	M10 Zn Beam Clamp	BEAMHM10	\$4.46	1
	M12 Zn Beam Clamp	BEAMHM12	\$8.80	1
	M10 HDG Beam Clamp	BEAMHM10G	\$8.59	1
	M12 HDG Beam Clamp	BEAMHM12G	\$11.91	1

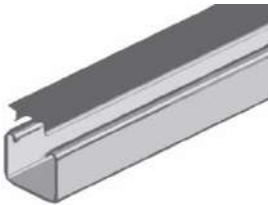

Closure Strips			
Details		\$/m	Qty
Grey Plastic Closure Strip x 3 Mtrs	INSCLSR	19.56	1

Rubber Insulation	Other Thicknesses are Also Available	\$/m	
	INSRUB	4.11	m



## Mechanical & Industrial Services

Ferrule Blocks - 19 & 25mm Wall Thickness	19mm FERRULE BLOCKS			
	ID	OD	Code	\$/each
	6	46	FER006-46	\$5.29
	9	49	FER009-49	\$5.55
	13	51	FER013-51	\$4.31
	16	57	FER016-57	\$4.31
	20	57	FER020-57	\$4.36
	22	60	FER022-60	\$4.36
	25	63	FER025-63	\$5.18
	27	67	FER027-67	\$5.66
	32	70	FER032-70	\$5.92
	34	73	FER034-73	\$6.11
	38	76	FER038-76	\$6.48
	42	79	FER042-79	\$7.17
	48	86	FER048-86	\$7.39
	51	89	FER051-89	\$8.00
	54	89	FER054-89	\$8.19
	60	98	FER060-98	\$8.97
	64	102	FER064-102	\$9.51
	67	102	FER067-102	\$9.53
	76	114	FER076-114	\$11.01
	89	127	FER089-127	\$12.65
	102	140	FER102-140	\$14.47
	115	152	FER115-152	\$17.05
	127	165	FER127-165	\$18.68
	140	178	FER140-178	\$18.68
	154	203	FER154-203	\$25.44
	168	203	FER168-203	\$28.06
	203	250	FER204-250	\$36.21
	219	250	FER219-250	\$35.90

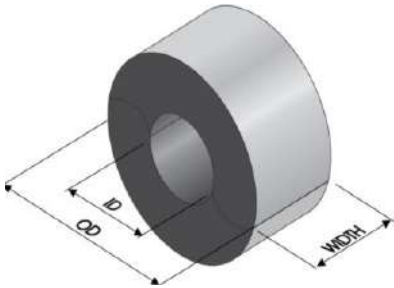

\*Indicates sizes that require specifically sized manufactured channel clips

## Mechanical & Industrial Services

Ferrule Blocks - 19 & 25mm Wall Thickness	25mm FERRULE BLOCKS				
	ID	OD	Code	\$/each	Qty Pkt
	6	57	FER006-57	\$5.37	1
	9	60	FER009-60	\$5.66	1
	13	63	FER013-63	\$5.29	1
	16	67	FER016-67	\$5.76	1
	20	70	FER020-70	\$6.02	1
	22	73	FER022-73	\$6.20	1
	25	76	FER025-76	\$6.35	1
	27	76	FER027-76	\$6.65	1
	32	83	FER032-83	\$7.32	1
	34	83	FER034-83	\$7.35	1
	38	89	FER038-89	\$8.62	1
	42	89	FER042-89	\$8.88	1
	48.00	98	FER048-98	\$9.14	1
	51.00	102	FER051-102	\$10.34	1
	54.00	102	FER054-102	\$10.94	1
	60.00	110	FER060-110	\$11.53	1
	64.00	114	FER064-114	\$13.17	1
	67.00	114	FER067-114	\$13.35	1
	76	127	FER076-127	\$13.52	1
	89	140	FER089-140	\$14.00	1
	102	152	FER102-152	\$18.87	1
	115	165	FER115-165	\$18.98	1
	127	178	FER127-178	\$23.01	1
	140	203	FER140-203	\$24.20	1
	154	203	FER154-203	\$25.44	1
	168	220	FER168-220	\$28.38	1
	203	250	FER204-250	\$36.21	1
	219	275	FER219-275	\$41.25	1

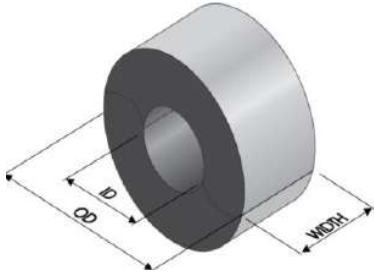

\*Indicates sizes that require specifically sized manufactured channel clips



## Mechanical & Industrial Services

CHANNEL CLIPS	Actual Size	Powder Coated		Galvanised		Hot Dipped Gal.		Stainless Steel		Qty Pkt
		Code	\$/each	Code	\$/each	Code	\$/each	Code	\$/each	
	10.7	CH0107P	\$1.46	CH0107	\$1.20	CH0107G	\$2.00			100
	12.7	CH0127P	\$1.46	CH0127	\$1.20	CH0127G	\$2.00	CH0127S	\$5.39	100
	14					CH0140G	\$0.87			
	16			CH01588	\$1.68					100
	17.1	CH0171P	\$1.84	CH0171	\$1.45	CH0171G	\$2.30			100
	19.1	CH0191P	\$1.60	CH0191	\$1.20	CH0191G	\$2.00	CH0191S	\$5.84	100
	21			CH0214	\$1.28					100
	21.3			CH0213	\$1.57	CH0213G	\$1.99			100
	22			CH0220	\$1.68	CH0220G	\$1.99	CH0220S	#N/A	100
	24	CH0240P	\$1.76	CH0240	\$1.32	CH0240G	\$2.33			100
	25.4	CH0254P	\$1.76	CH0254	\$1.43	CH0254G	\$2.33	CH0254S	\$6.39	100
	27			CH0270	\$1.44			CH0270S	\$9.49	100
	29.8	CH0298P	\$1.94	CH0298	\$1.58	CH0298G	\$2.55	CH0298S	\$6.81	100
	31.8	CH0318P	\$1.77	CH0318	\$1.58	CH0318G	\$2.55	CH0318S	\$8.72	100
	34.1	CH0341P	\$2.03	CH0341	\$1.58	CH0341G	\$2.66	CH0341S	\$7.36	100
	38.1	CH0381P	\$2.15	CH0381	\$1.73	CH0381G	\$2.77	CH0381S	\$7.69	100
	40	CH0400P		CH0400	\$1.60			CH0400S	\$7.69	100
	42.8	CH0430P	\$2.34	CH0430	\$1.89	CH0430G	\$2.99	CH0430S	\$8.15	100
	46.4	CH0464P	\$4.53	CH0464	\$3.94	CH0464G	\$5.12			50
	48.4	CH0484P	\$2.54	CH0484	\$2.34	CH0484G	\$3.65	CH0484S	\$9.67	50
	50.8	CH0508P	\$3.12	CH0508	\$2.47	CH0508G	\$3.82	CH0508S	\$14.12	50
	57.1	CH0571P	\$3.60	CH0571	\$3.03	CH0571G	\$4.40			50
	60.3	CH0603P	\$3.44	CH0603	\$2.70	CH0603G	\$4.12	CH0603S	\$11.52	50
	63.5	CH0635P	\$3.76	CH0635	\$3.18	CH0635G	\$4.76	CH0635S	\$12.14	50
	67			CH0670	\$3.21					50
	69.8	CH0700P	\$4.80	CH0700	\$4.21	CH0700G	\$5.86	CH0700S	\$12.76	50
	73			CH0730	\$3.37					50
	76.2	CH0762P	\$4.50	CH0762	\$3.63	CH0762G	\$5.30	CH0762S	\$14.34	50
	79			CH0790	\$3.92					50
	82.5	CH0825P	\$4.94	CH0825	\$4.19	CH0825G	\$6.11	CH0825S	\$16.61	50
	86			CH0860	\$5.19					50
	88.9	CH0889P	\$4.98	CH0889	\$3.92	CH0889G	\$5.71	CH0889S	\$15.59	50
	98			CH0980	\$5.55					50
	101.6	CH1016P	\$6.33	CH1016	\$5.14	CH1016G	\$8.15	CH1016S	\$21.26	25
	102							CH1020S	\$20.25	25
	111.1	CH1111P	\$6.72	CH1111	\$5.82	CH1111G	\$8.62	CH1111S	\$22.74	25
	114.3	CH1143P	\$6.72	CH1143	\$5.44	CH1143G	\$8.62	CH1143S	\$21.31	25
	127	CH1270P	\$8.35	CH1270	\$7.20	CH1270G	\$10.31	CH1270S	\$24.04	1
	140	CH1400P	\$8.72	CH1400	\$7.52	CH1400G	\$10.78	CH1400S	\$26.96	1
	152.4	CH1524P	\$9.92	CH1524	\$8.64	CH1524G	\$12.44	CH1524S	\$31.67	1
	162			CH1620	\$9.12	CH1620G	\$13.15	CH1620S	\$31.47	1
	165	CH1650P	\$10.45	CH1650	\$9.12	CH1650G	\$13.15	CH1650S	\$31.47	1
	168	CH1681P	\$10.45	CH1681	\$11.28	CH1681G	\$12.29	CH1681S	\$33.68	1
	178	CH1780P	\$11.02	CH1780	\$9.60	CH1780G	\$13.87	CH1780S	\$36.46	1
	203	CH2300P	\$13.37	CH2300	\$11.85	CH2300G	\$17.19	CH2300S	\$45.71	1
	219			CH2190	\$10.30	CH2190G	\$21.20	CH2190S	\$17.21	1
	225					CH2250G	\$44.25	CH2250S	\$49.16	1
	228			CH2280	\$21.20					1
	250	CH2500P	\$17.21	CH2500	\$12.50	CH2500G	\$21.20	CH2500S	\$49.16	1
	283			CH2830	\$31.70					1
	303	CH3030P	\$19.07	CH3030	\$16.85	CH3030G	\$23.23	CH3030S	\$56.28	1
	315			CH3150	\$16.85			CH3150S	\$59.78	1
	355			CH3550	\$35.23					1
	375							CH3750S	\$68.91	1
	400			CH4000	\$35.70			CH4000S	\$77.87	1

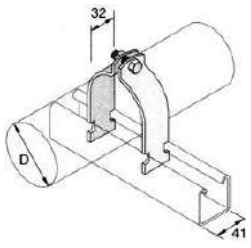

*\*Indicates Goods With Limited Stock Supplies*

**All Powder Coated Sizes Are Made to Order**

Ph: 02 9525 0970

Fax: 02 9540 2899

Email: orders@arrowsales.com.au

## Mechanical & Industrial Services

**Square Washer**

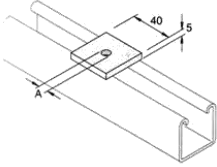

Hot Dipped Galvanised		Qty
Code	\$/each	Pkt
SX001	\$1.07	100
Details		
Width	Length	Thickness
40	40	5

**2 Hole Plate**

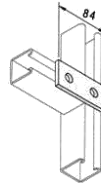

Hot Dipped Galvanised		Qty
Code	\$/each	Pkt
SX002	\$2.40	100
Details		
Width	Length	Thickness
40	84	5

SECTION B

**3 Hole Plate**

SECTION D

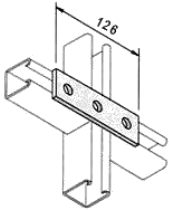

Hot Dipped Galvanised		Qty
Code	\$/each	Pkt
SX003	\$3.62	100
Details		
Width	Length	Thickness
40	126	5

**4 Hole Plate**

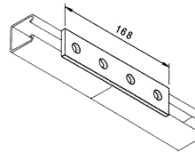

Hot Dipped Galvanised		Qty
Code	\$/each	Pkt
SX004	\$4.67	100
Details		
Width	Length	Thickness
40	168	5

**5 Hole Plate**

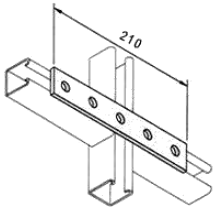

Hot Dipped Galvanised		Qty
Code	\$/each	Pkt
SX005	\$5.91	100
Details		
Width	Length	Thickness
40	210	5

**2 Hole 90 Degree Angle**

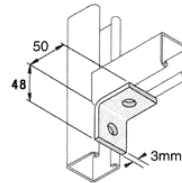

Hot Dipped Galvanised		Qty
Code	\$/each	Pkt
SX006	\$2.81	100
Details		
Width	Length	Thickness
48	50	5

**4 Hole 90 Degree Angle**

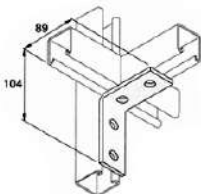

Hot Dipped Galvanised		Qty
Code	\$/each	Pkt
SX007	\$6.29	100
Details		
Width	Length	Thickness
89	104	5

**Base Plate**

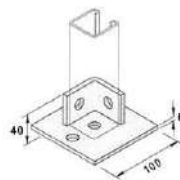

Hot Dipped Galvanised		Qty
Code	\$/each	Pkt
SX008	\$23.30	100
Details		
Width	Length	Thickness
40	126	5

**2 Hole Braced 90 Degree Angle**

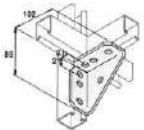

Hot Dipped Galvanised		Qty
Code	\$/each	Pkt
SX009	\$15.74	100
Details		
Width	Length	Thickness
40	168	5

**Square Saddle**

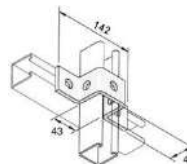

Hot Dipped Galvanised		Qty
Code	\$/each	Pkt
SX010	\$6.45	100
Details		
Width	Length	Thickness
40	210	5

## Mechanical & Industrial Services

Flat "L" Shape

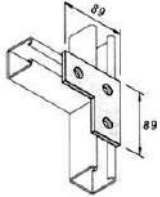

HDG		Qty Pkt
Code	\$/each	
SX011	\$5.24	100
Details		
Width	Length	Thickness
48	50	6

Flate "T" Shape

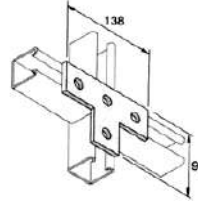

Hot Dipped Galvanised		Qty Pkt
Code	\$/each	
SX012	\$8.06	100
Details		
Width	Length	Thickness
89	104	6

50mm Beam Clamp

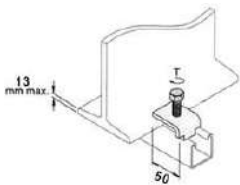

HDG		Qty Pkt
Code	\$/each	
SX013	\$3.24	100
Details		
Width	Length	Thickness
40	126	6

Support Beam Clamp

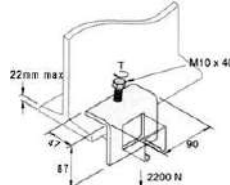

Hot Dipped Galvanised		Qty Pkt
Code	\$/each	
SX014	\$8.19	100
Details		
Width	Length	Thickness
40	168	6

3 Hole 90 Degree

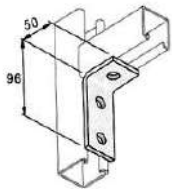

HDG		Qty Pkt
Code	\$/each	
SX015	\$5.88	1
Details		
Width	Length	Thickness
40	98	2

"Z" Shape Bracket

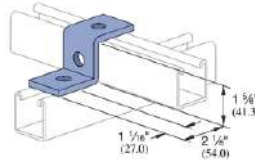

Hot Dipped Galvanised		Qty Pkt
Code	\$/each	
SX016	\$6.43	1
Details		
Width	Length	Thickness
40	95	6

Double Base Plate

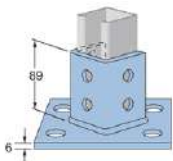

HDG		Qty Pkt
Code	\$/each	
SX017	\$31.86	1
Details		
Width	Length	Thickness
40	89	6

"U" Shape Bracket

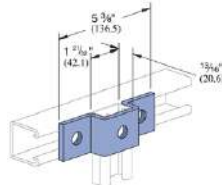

Hot Dipped Galvanised		Qty Pkt
Code	\$/each	
SX018	\$7.65	1
Details		
Width	Length	Thickness
40	138	6

45 Degree Angle Bracket

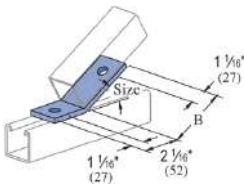

HDG		Qty Pkt
Code	\$/each	
SX019	\$6.28	1
Details		
Width	Length	Thickness
40	138	6

Winged Shaped Bracket

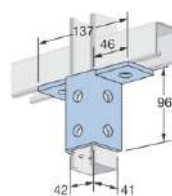

Hot Dipped Galvanised		Qty Pkt
Code	\$/each	
SX020	\$19.26	1
Details		
Width	Length	Thickness
40	52	6

4 Hole Post Base

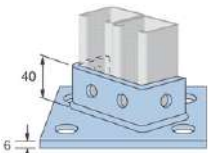

HDG		Qty Pkt
Code	\$/each	
SX021	\$31.47	1
Details		
Width	Length	Thickness
40	137	6

Electrical Hanger Fitting



Hot Dipped Galvanised		Qty Pkt
Code	\$/each	
SX022	\$9.14	1
Details		
Width	Length	Thickness
40	69	6

## Mechanical & Industrial Services

**Splice Fitting - External Joiner**

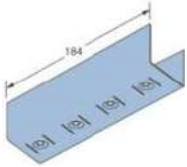

Zinc Plated		Qty
Code	\$/each	Pkt
SX023	\$7.27	1
Details		
Width	Length	Thickness
41	184	6

**Internal Channel Joiner**

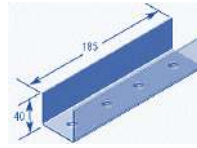

Hot Dipped Galvanised		Qty
Code	\$/each	Pkt
SX024	\$9.14	1
Details		
Width	Length	Thickness
40	185	6

**Trolley Assembly - 2 Wheel**

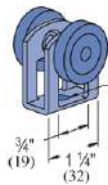

Hot Dipped Galvanised		Qty
Code	\$/each	Pkt
SX025	\$50.52	1
Details		
Width	Length	Thickness
32	43	11

**Trolley Assembly - 4 Wheel**

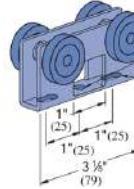

Hot Dipped Galvanised		Qty
Code	\$/each	Pkt
SX026	\$73.31	1
Details		
Width	Length	Thickness
32	80	11

**Trolley Assembly - 4 Wheel/3 Hole**

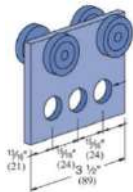

Hot Dipped Galvanised		Qty
Code	\$/each	Pkt
SX027	\$83.05	1
Details		
Width	Length	Thickness
32	90	6

**Flat Plate - 4 Hole**

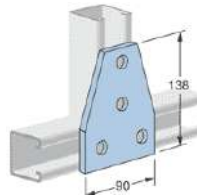

Hot Dipped Galvanised		Qty
Code	\$/each	Pkt
SX028	\$15.64	1
Details		
Width	Length	Thickness
90	139	6

**Angle Bracket (1035)**

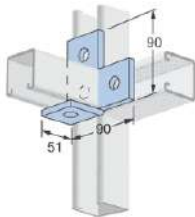

Hot Dipped Galvanised		Qty
Code	\$/each	Pkt
SX029	\$9.57	1
Details		
Width	Length	Thickness
90	90	6

**Angle Bracket (1034)**

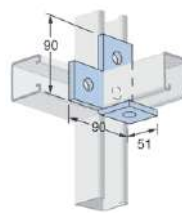

Hot Dipped Galvanised		Qty
Code	\$/each	Pkt
SX030	\$9.57	1
Details		
Width	Length	Thickness
90	90	6

**Angle Bracket (1359)**

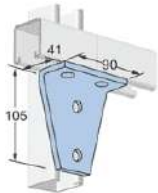

Hot Dipped Galvanised		Qty
Code	\$/each	Pkt
SX031	\$13.65	1
Details		
Width	Length	Thickness
90	105	6

**41 x 41 Plastic End**

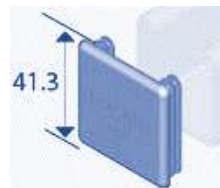

For C1000/C2000 Series		Qty
Code	\$/each	Pkt
END4141	\$1.42	1
Details		
Width	Length	Thickness
41	41	2

**21 x 41 Plastic End**

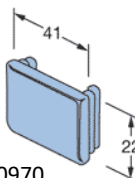

For C3000/C4000 Series		Qty
Code	\$/each	Pkt
END2141	\$1.42	1
Details		
Width	Length	Thickness
21	41	2

**62 x 41 Plastic End**

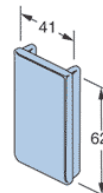

For C5000 Series		Qty
Code	\$/each	Pkt
END5041	\$2.93	1
Details		
Width	Length	Thickness
62	41	2

## MECHANICAL SERVICES CHANNEL ACCESSORIES



FAST TRAK STRUT		
CODE	DESCRIPTION	\$/Length
CAPOLOGST	Galvanised Metal - Channel Strut for self locking Pipe Clamps - 20mm Wide x 8mm High x 2 metre Lengths	\$19.41
CAPOLOPST	PVC - Channel Strut for Self locking Pipe Clamps - 25mm wide x 11mm High x 1m Lengths	\$13.00



FAST TRAK SYSTEM		
Code	Description	\$/each
CAPOLO12	Polymide Pipe Clip 12 to 13mm	\$1.09
CAPOLO14	Polymide Pipe Clip 14 to 18mm	\$1.52
CAPOLO20	Polymide Pipe Clip 20 to 25mm	\$2.16
CAPOLO26	Polymide Pipe Clip 26 to 32mm	\$2.59
CAPOLO35	Polymide Pipe Clip 35 to 42mm	\$3.39
CAPOLO47	Polymide Pipe Clip 47 to 50mm	\$5.30





## TRUNKING

PIPE DUCT			
CODE	DESCRIPTION	\$/each	Qty
PD80V2	80mm PVC Pipe Duct - 2m	\$41.75	10
PD100V2	100mm PVC Pipe Duct - 2m	\$72.11	8

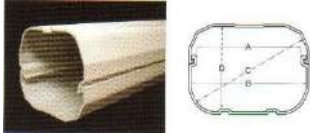

CORNER			
CODE	DESCRIPTION	\$/each	Qty
PD80C	80mm PVC Pipe Duct Corner	\$18.22	20
PD100C	100mm PVC Pipe Duct Corner	\$32.11	15

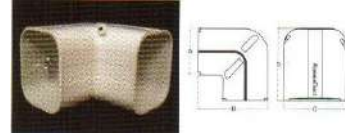

WALL CAP			
CODE	DESCRIPTION	\$/each	Qty
PD80WC	80mm PVC Pipe Duct Wall Cap	\$17.84	20
PD100WC	100mm PVC Pipe Duct Wall Cap	\$31.54	12

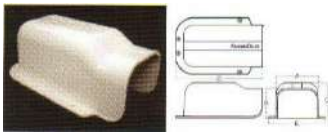

FLEXIBLE DUCT			
CODE	DESCRIPTION	\$/each	Qty
PD80FJ	80mm PVC Pipe Flexible Duct	\$20.72	10
PD100FJ	100mm PVC Pipe Flexible Duct	\$41.78	10

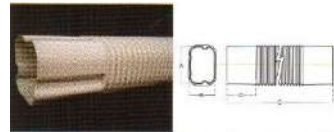

ELBOW			
CODE	DESCRIPTION	\$/each	Qty
PD80E	80mm PVC Pipe Duct Elbow	\$18.22	20
PD100E	100mm PVC Pipe Duct Elbow	\$31.54	12

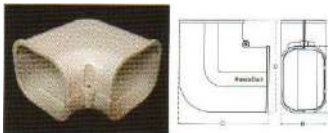

JOINER			
CODE	DESCRIPTION	\$/each	Qty
PD80J	80mm PVC Pipe Duct Joiner	\$6.41	20
PD100J	100mm PVC Pipe Duct Joiner	\$10.97	10

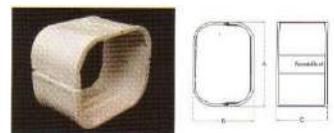

CEILING CAP			
CODE	DESCRIPTION	\$/each	Qty
PD80CC	80mm PVC Pipe Duct Ceiling Cap	\$18.79	20
PD100CC	100mm PVC Pipe Duct Ceiling Cap	\$24.93	16

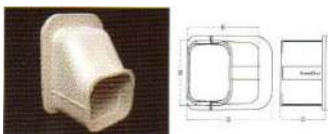

MOUNTING BLOCK			
CODE	DESCRIPTION	\$/each	Qty
PDMBIV	450mm PVC Mounting Block	\$23.04	24

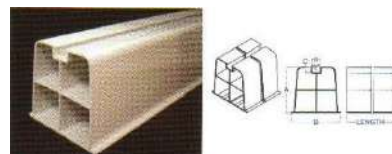



## COLOUR BOND TRUNKING

CODE	DESCRIPTION	\$/each	Qty
TRUNKB	TRUNKING 2.4m NIGHT SKY (BLACK)	\$50.96	1
TRUNKCR	TRUNKING 2.4m CLASSIC CREAM (CREAM)	\$50.96	1
TRUNKDB	TRUNKING 2.4m LOFT (DARK BROWN)	\$50.96	1
TRUNKDG	TRUNKING 2.4m IRONSTONE (DARK GREY)	\$50.96	1
TRUNKDO	TRUNKING 2.4m DEEP OCEAN (DARK BLUE)	\$50.96	1
TRUNKDR	TRUNKING 2.4m MANOR RED (DARK RED)	\$50.96	1
TRUNKGL	TRUNKING 2.4m GALVANISED (GAL)	\$50.96	1
TRUNKGR	TRUNKING 2.4m BUSHLAND (MED GREY)	\$50.96	1
TRUNKLF	TRUNKING 2.4m LOFT (DARK BROWN/PURPLE)	\$50.96	1
TRUNKLG	TRUNKING 2.4m SHALE GREY (LIGHT GREY)	\$50.96	1
TRUNKLW	TRUNKING 2.4m EVENING HAZE (OFF WHITE)	\$50.96	1
TRUNKMB	TRUNKING 2.4m JASPER (MEDIUM BROWN)	\$50.96	1
TRUNKMG	TRUNKING 2.4m COTTAGE GREEN (DARK GREEN)	\$50.96	1
TRUNKMR	TRUNKING 2.4m HEADLAND (MED RED)	\$50.96	1
TRUNKPB	TRUNKING 2.4m PAPER BARK (OFF PINK)	\$50.96	1
TRUNKPG	TRUNKING 2.4m PALE EUCALYPT (PALE GREEN)	\$50.96	1
TRUNKSB	TRUNKING 2.4m SAND BANK (SAND OFF YELLOW)	\$50.96	1
TRUNKW	TRUNKING 2.4m SURFMIST (WHITE)	\$50.96	1
TRUNKWD	TRUNKING 2.4m WILDERNESS (MED GREEN)	\$50.96	1
TRUNKWG	TRUNKING 2.4m WOODLAND GREY (DARK GREY)	\$50.96	1
TRUNKWS	TRUNKING 2.4m WINDSPRAY (GREY)	\$50.96	1

## TRUNKING EZY DUCT

PIPE DUCT			
CODE	DESCRIPTION	\$/each	Qty
PDE80V2	80mm Ezy Cable Duct 2m	\$25.94	10
PDE100V2	100mm PVC Ezy Pipe Duct - 2m	\$45.60	8



CORNER			
CODE	DESCRIPTION	\$/each	Qty
PDE80C	80mm Ezy Duct Corner	\$10.05	20
PDE100C	100mm Ezy PVC Pipe Duct Corner	\$14.24	15



WALL CAP			
CODE	DESCRIPTION	\$/each	Qty
PDE80WC	80mm Ezy Duct Wall Cap	\$10.05	20
PDE100WC	100mm PVC Ezy Pipe Duct Wall Cap	\$14.24	12



FLEXIBLE DUCT			
CODE	DESCRIPTION	\$/each	Qty
PDE80FJ	80mm Ezy Duct Flexi Joiner	\$17.40	10
PDE100FJ	100mm PVC Pipe Flexible Duct	\$23.68	10



ELBOW			
CODE	DESCRIPTION	\$/each	Qty
PDE80E	80mm Ezy Duct Bend (flat)	\$10.05	20
PDE100E	100mm PVC Ezy Pipe Duct Bend (flat)	\$14.24	12



JOINER			
CODE	DESCRIPTION	\$/each	Qty
PDE80J	80mm Ezy Duct Joiner	\$4.20	20
PDE100J	100mm PVC Ezy Pipe Duct Joiner	\$7.68	10



CEILING CAP			
CODE	DESCRIPTION	\$/each	Qty
PDE80CC	80mm Ezy Duct Ceiling Cap	\$10.05	20
PDE100CC	100mm PVC Ezy Pipe Duct Ceiling Cap	\$14.24	16



**ALSO AVAILABLE**

Ph: 02 9525 0970

Fax: 02 9540 2899

Email: [orders@arrowsales.com.au](mailto:orders@arrowsales.com.au)

Please Note All Prices Are GST Exclusive

## CONSUMABLES



DISPOSABLE COVERALLS			
CODE	DESCRIPTION	\$/each	Qty
XDSPCOVXL	WHITE - XL	\$11.99	1



STEEL GRINDING WHEELS			
CODE	DESCRIPTION	\$/each	Qty
GRWCM100	100x16mm METALCUT-OFF WHEEL	\$4.48	1
GRWCM115	115x22mm METALCUT-OFF WHEEL	\$4.85	1
GRWCM125	125x22mm METALCUT-OFF WHEEL	\$5.62	1
GRWCM178	178mmx16mm METAL CUT-OFF WHEEL	\$6.81	1
GRWCM180	178mmx22mm METAL CUT-OFF WHEEL	\$6.81	1
GRWCM230	230x22mm METALCUT-OFF WHEEL	\$9.87	1
GRWCM250	230x25mm METALCUT-OFF WHEEL	\$8.13	1
GRWCM300	300x3x25mm L/SMETAL C/O WHEEL	\$21.33	1
GRWCM355	355x3x25 L/S METAL C/O WHEEL	\$31.69	1



MASONRY GRINDING WHEELS			
CODE	DESCRIPTION	\$/each	Qty
GRWCC100	100x16mm MASONRY C/OFF WHEEL	\$4.48	1
GRWCC115	115x22mm MASONRY C/OFF WHEEL	\$4.85	1
GRWCC125	125x22mm MASONRY C/OFF WHEEL	\$5.62	1
GRWCC178	178mmx22mm MASONRY C/O WHEEL	\$6.81	1
GRWCC230	230x22mm MASONRY C/OFF WHEEL	\$9.87	1
GRWCC250	230x25mm MASONRY C/OFF WHEEL	\$8.13	1



CORDLESS DRILL BIT ENDS			
CODE	DESCRIPTION	\$/each	Qty
BIT7CED	45mm DOUBLE END PHILLIPS BIT	\$1.60	1
BIT7MS1	No 1 x 42mm MAGNETIC SOCKET	\$6.59	1
BIT7MS2	5/16 x 69mm MAGNETIC SOCKET	\$6.94	1
BIT7MS3	No 3 x 42mm MAGNETIC SOCKET	\$8.35	1
BIT7PED	No 2 x 45mm D/E POZIDRIVE BITS	\$2.42	1
BITXCS2	No 2 x 25mm PHILLIPS BIT-BULK	\$1.45	1
BITXDS2	No.2x25mm PHILLIPS Drywall Bit	\$3.85	1

## CONSUMABLES



DUCT AND FUME MASKS			
CODE	DESCRIPTION	\$/each	Qty
MASKD	DUSK MASKS	POA	50
XMASKP2V	P2M - Valve Mask	POA	10



MASONRY DRILLS ECONOMY			
CODE	DESCRIPTION	\$/each	Qty
DRILLM65-100	6.5mm MASONRY DRILL -100mm	\$5.62	1
DRILLM8-120	8mm MASONRY DRILL - 120mm	\$7.72	1
DRILLM10-120	10mm MASONRY DRILL - 120mm	\$9.11	1
DRILLM12-150	12mm MASONRY DRILL - 150mm	\$14.55	1



MASONRY DRILL   SDS TYPE			
CODE	DESCRIPTION	\$/each	Qty
DRILLSDS05160	SDS Plus Bit 5mm x 160mm	\$13.58	1
DRILLSDS06110	SDS Plus Bit 6.5mm x 110mm	\$10.74	1
DRILLSDS06160	SDS Plus Bit 6mm x 160mm	\$14.91	1
DRILLSDS08110	SDS Plus Bit 8mm x 110mm	\$12.29	1
DRILLSDS08160	SDS Plus Bit 8mm x 160mm	\$15.55	1
DRILLSDS10110	SDS Plus Bit 10mm x 110mm	\$14.26	1
DRILLSDS10160	SDS Plus Bit 10mm x 160mm	\$16.07	1
DRILLSDS12160	SDS Plus Bit 12mm x 160mm	\$21.92	1



GLOVES			
CODE	DESCRIPTION	\$/each	Qty
GLVCDY	Candy Striped Gloves	\$5.00	1
GLVCTN	Cotton Gloves	\$4.00	1



## TOOLS AVAILABLE

### PIPE CUTTERS



### THREADE ROD CUTTERS



### SETTING TOOLS



### CHISEL POINTS

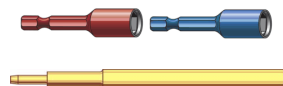

Ph: 02 9525 0970

Fax: 02 9540 2899

Email: [orders@arrowsales.com.au](mailto:orders@arrowsales.com.au)

Please Note All Prices Are GST Exclusive



## FLEXIBLE DUCT

PRODUCT INFO			
Type	Thermaflex	Colour	Silver
Function	Air Diffusion	Material	Metallised Outer Sleeve
Mount			Fire Rated to AS4254

Thermaflex R0.6					
	Product Code	Diameter Metric	Diameter Imperial	Length Metres	Price
	VTFP66	150	6	6	\$37.23
	VTFP86	200	8	6	\$41.29
	VTFP106	250	10	6	\$52.11
	VTFP106	250	10	6	\$52.11
	VTFP126	300	12	6	\$57.90
	VTFP146	350	14	6	\$68.62
	VTFP166	400	16	6	\$78.45
	VTFP186	450	18	6	\$104.88
VTFP206	500	20	6	\$122.53	

Thermaflex R1.0					
	Product Code	Diameter Metric	Diameter Imperial	Length Metres	Price
	VRITFP66	150	6	6	\$42.09
	VRITFP86	200	8	6	\$47.81
	VRITFP106	250	10	6	\$59.27
	VRITFP126	300	12	6	\$72.69
	VRITFP146	350	14	6	\$81.04
	VRITFP166	400	16	6	\$88.67
	VRITFP186	450	18	6	\$130.24
	VRITFP206	500	20	6	\$144.90

Thermaflex R1.5					
	Product Code	Diameter Metric	Diameter Imperial	Length Metres	Price
	VRI5TFP66	150	6	6	\$87.16
	VRI5TFP86	200	8	6	\$76.28
	VRI5TFP106	250	10	6	\$92.36
	VRI5TFP126	300	12	6	\$106.92
	VRI5TFP146	350	14	6	\$121.77
	VRI5TFP166	400	16	6	\$142.15
	VRI5TFP186	450	18	6	\$171.53
	VRI5TFP206	500	20	6	\$184.37

Ph: 02 9525 0970

Fax: 02 9540 2899

Email: orders@arrowsales.com.au

Please Note All Prices Are GST Exclusive



PRODUCT INFORMATION			
Type	Acoustiduct	Colour	Silver
Function	Air Diffusion	Material	Metallized Outer Sleeve
Mount			Acoustic Inner Core

Acoustiduct					
	Product Code	Diameter Metric	Diameter Imperial	Length Metres	Price
	VAC146	350	14	6	\$87.47
	VAC166	400	16	6	\$96.71
	VAC186	450	18	6	\$123.72
	VAC206	500	20	6	\$146.09

PRODUCT INFORMATION			
Type	Foilflex	Colour	Silver
Function	Air Diffusion	Material	Aluminium Foil
Mount			Fire Rated to 1530.4 Zero

Foilflex					
	Product Code	Diameter Metric	Diameter Imperial	Length Metres	Price
	VFF4ZG66	150	6	6	\$54.26
	VFF4ZG86	200	8	6	\$68.08
	VFF4ZG106	250	10	6	\$80.86
	VFF4ZG126	300	12	6	\$96.37
	VFF4ZG146	350	14	6	\$109.56
	VFF4ZG166	400	16	6	\$122.77
	VFF4ZG186	450	18	6	\$139.94
	VFF4ZG206	500	20	6	\$153.36

PRODUCT INFORMATION			
Type	Thermafex Plain	Colour	Silver
Function	Ventilation and Exhaust	Material	Uninsulated Duct
Mount			Fire Rated to AS4254 -1995

Thermafex Plain					
	Product Code	Diameter Metric	Diameter Imperial	Length Metres	Price
	VSBN66	150	6	6	\$17.69
	VSBN86	200	8	6	\$25.69
	VSBN106	250	10	6	\$33.89
	VSBN126	300	12	6	\$41.99
	VSBN146	350	14	6	\$49.62
	VSBN166	400	16	6	\$105.24

## CEILING MOUNTED GRILLS

### Lay-in Diffusers

PRODUCT INFORMATION			
Type	Lay-in/Flush Face Diffusers	Varieties	2
Function	Supply Air	Colour	White Powder Coat
Mount	Ceiling or Lay-in Grid	Material	Aluminium

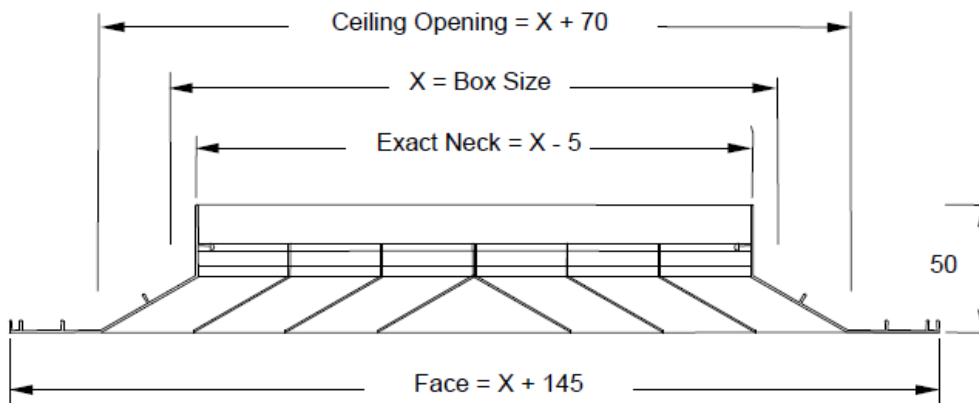

Lay-In 4-Way Blow Diffuser					
	Product Code	Face Size Metric	Nominal Size Metric	Pieces/Carton	Price
	VFFTBS	395 x 395 Face	250 x 250	8	\$66.96
	VFFTB	595 x 595 Face	450 x 450	10	\$63.09
*Grilles are aluminium powder coated white as standard					

## Reducing Necks for Lay-in Diffusers

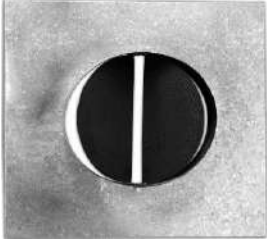
Reducing Necks					
	Product Code	Nominal Neck Metric	Spigot Size Imperial	Compatible Grills	Price
	VFFTBR200	450 x 450	8	VFFTB3W	\$24.71
				VFFTB	POA
	VFFTBR250	450 x 450	10		\$27.09
	VFFTBR300	450 x 450	12		\$24.71
	VECGFRN595F	550 x 550	10		\$29.38
*All Reducing Necks are sprayed black as standard					

## Flush Face Diffusers

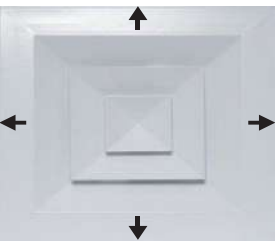
4-Way Flush Face Diffusers					
	Product Code	Nominal Neck Metric	Nominal Neck Imperial	Pieces/Carton	Price
	VFM466	150 x 150	6 x 6	10	\$42.98
	VFM499	225 x 225	9 x 9	10	\$87.05
	VFM41212	300 x 300	12 x 12	10	\$78.73
	VFM41515	375 x 375	15 x 15	10	\$72.56
*Grilles are aluminium powder coated white as standard					

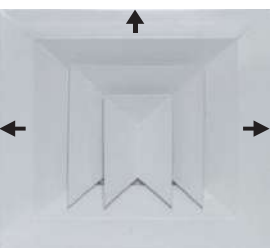
3 Way Flush Face Diffusers					
	Product Code	Nominal Neck Metric	Nominal Neck Imperial	Pieces/Carton	Price
	VFM366	150 x 150	6 x 6	10	\$51.56
	VFM399	225 x 225	9 x 9	10	\$67.57
	VFM31212	300 x 300	12 x 12	10	\$72.27
	VFM31515	375 x 375	15 x 15	10	\$87.06
*Grilles are aluminium powder coated white as standard					

## Bevelled Edge Diffuser

PRODUCT INFORMATION			
Type	Bevelled Edge Diffuser	Varieties	8
Function	Supply Air	Colour	Powder Coated White
Mount	Ceiling	Material	Aluminium

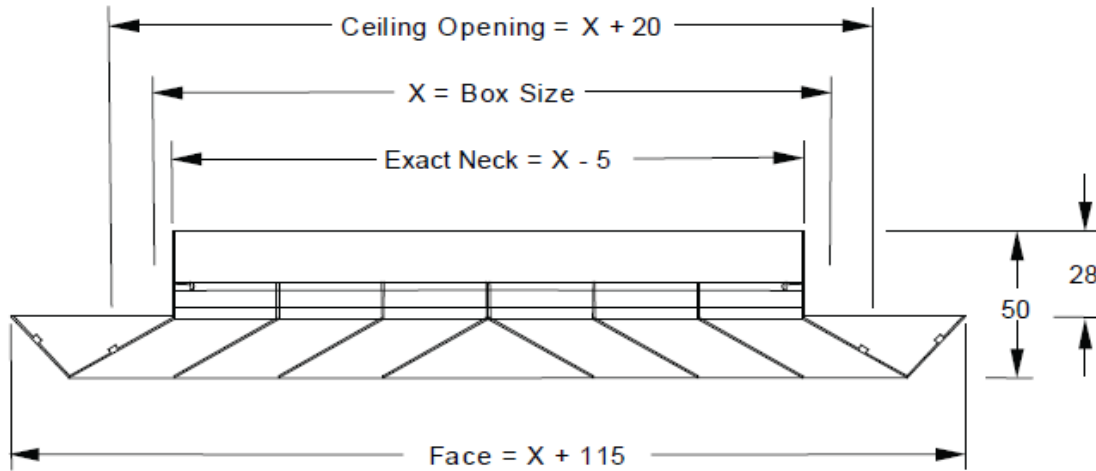

4 Way Bevelled Edge Diffuser					
	Product Code	Nominal Neck Metric	Nominal Neck Imperial	Pieces/Carton	Price
	VBF4W66	150 x 150	6 x 6	10	\$47.68
	VBF4W99	225 x 225	9 x 9	10	\$59.22
	VBF4W1212	300 x 300	12 x 12	10	\$61.80
	VBF4W1515	375 x 375	15 x 15	10	\$76.56
	VBF4W1818	450 x 450	18 x 18	10	\$94.34
	VBF4W2121	525 x 525	21 x 21	10	\$127.02
	VBF4W2424	600 x 600	24 x 24	10	\$184.38
*Grilles are aluminium powder coated white as standard					

4 Way with Fixing Clip Reducing Neck					
	Product Code	Nominal Neck Metric	Nominal Neck Imperial	Pieces/Carton	Price
	VBF4W998	225 x 225	200	4	\$75.46
	VBF4W12128	300 x 300	200	4	\$75.01
	VBF4W121210	300 x 300	250	4	\$75.01
	VBF4W121212	300 x 300	300	4	\$75.01
*Grilles are aluminium p/c white as standard					

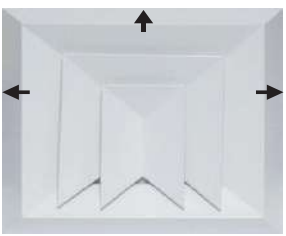
3 Way Bevelled Edge Diffuser					
	Product Code	Nominal Neck Metric	Nominal Neck Imperial	Pieces/Carton	Price
	VBF3W66	150 x 150	6 x 6	10	\$49.94
	VBF3W99	225 x 225	9 x 9	10	\$68.27
	VBF3W1212	300 x 300	12 x 12	10	\$71.17
	VBF3W1515	375 x 375	15 x 15	10	\$88.16
	VBF3W1818	450 x 450	18 x 18	8	\$103.76
*Grilles are aluminium powder coated white as standard					

Bevelled Edge 3 Way Rectangular					
	Product Code	Nominal Neck Metric	Nominal Neck Imperial	Pieces/Carton	Price \$
	VBF3W156	375 x 150	15 x 6	10	\$92.16
*Grilles are aluminium powder coated white as standard					

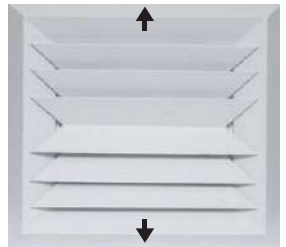
Bevelled Edge 2 Way Opposite					
	Product Code	Nominal Neck Metric	Nominal Neck Imperial	Pieces/Carton	Price
	VBF2W1212	300 x 300	12 x 12	10	\$79.08
	VBF2W1515	375 x 375	15 x 15	10	\$97.96
*Grilles are aluminium powder coated white as standard					

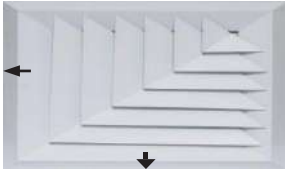
Bevelled Edge 2 Way Corner					
	Product Code	Nominal Neck Metric	Nominal Neck Imperial	Pieces/Carton	Price
	VBF1W1212	300 x 300	12 x 12	10	\$88.97
	VBF1W1515	375 x 375	15 x 15	10	\$110.20
*Grilles are aluminium powder coated white as standard					

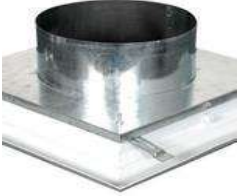
Reducing Neck with Fixing Clip for Bevelled Edge Diffusers					
	Product Code	Nominal Neck Metric	Nominal Neck Imperial	Spigot Sizes	Price
	VBFNA12128	300 x 300	12 x 12	200 - 300	\$27.90
	VBFNA15158	375 x 375	15 x 15	200 - 300	\$27.90
	VBFNA18188	450 x 450	18 x 18	200 - 300	\$27.90

## Removable Core Linear Slot Diffuser

Product Information			
Type	Linear Slot Diffuser	Varieties	2 (2 or 3 Slots)
Function	Supply Air	Colour	White P/C & Black Anodised Blade
Mount	Ceiling or Wall		Aluminium, Safety Cable, Rem. Core

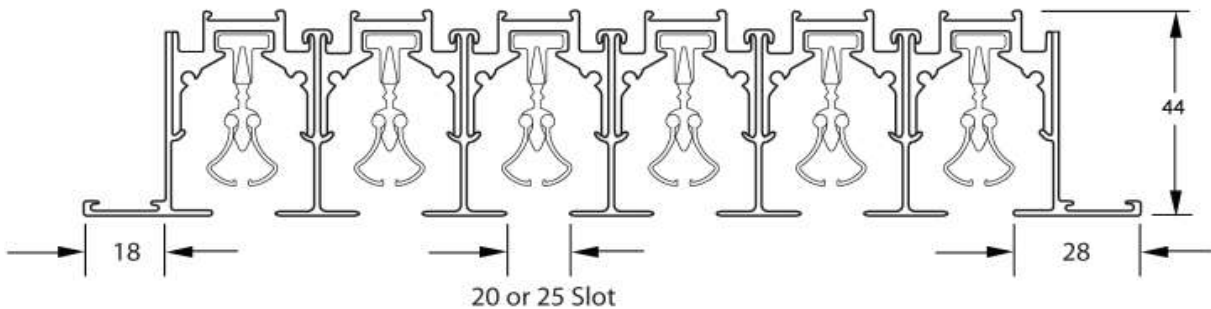

Removable Core Linear Slot Diffuser					
	Product Code	Nominal Neck Imperial	Exact Neck Metric	Face Size Metric	Price
	VRCLS600	12 x 12	590 x 97	638 x 145	\$102.30
	VRCLS900	15 x 15	890 x 97	938 x 145	\$149.25
Comes in 5 pieces per carton					
*Diffusers are aluminium powder coated white & c/w black anodised blades					
*All RCLS come complete with safety chains					



## Round Aluminium Diffuser

PRODUCT INFORMATION			
Type	Round Aluminium Diffuser	Colour	White Powder Coat
Function	Supply Air	Material	Aluminium
Mount	Ceiling		Polymer Damper Blade

Round Aluminium Diffuser						
	Product Code	Exact Neck Metric	Nominal Neck Imperial	Face Size Metric	Cut Out Size Metric	Price
	VRCD6	150	6	300	250	\$98.08
	VRCD8	200	8	350	300	\$124.85
	VRCD10	250	10	400	350	\$133.31
	VRCD12	300	12	450	400	\$168.06
*Fixing Clips available upon request						

## UNIFLO Round Diffuser

PRODUCT INFORMATION			
Type	UNIFLO Round Diffuser	Colour	White
Function	Supply Air	Material	ABS Polymer
Mount	Ceiling		Snap Down Fixing Clip

UNIFLO Round Diffuser						
	Product Code	Nominal Neck Metric	Nominal Neck Imperial	Face Size Metric	Cut Out Size Metric	Price
	VRPD06	150	6	255	235	\$20.53
	VRPD8	200	8	320	285	\$32.00
	VRPD10	250	10	390	355	\$30.15
	VRPD12	300	12	435	410	\$39.39
*Grilles complete with snap down fixing clip & dual spring arrangement						

## JETFLO Round Diffuser

PRODUCT INFORMATION			
Type	JETFLO Round Diffuser	Colour	White
Function	Supply or Exhaust Air	Material	ABS Polymer
Mount	Ceiling		Snap Down Fixing Clip

JETFLO Diffuser						
	Product Code	Nominal Neck Metric	Nominal Neck Imperial	Cut Out Size Metric	Cut Out Size Imperial	Price
	VJF6	150	6	205	8	\$16.73
	VJF8	200	8	260	10	\$22.97
	VJF10	250	10	305	12	\$34.86
*Suitable for heating, cooling and exhaust applications						

## Multi Directional Outlet

PRODUCT INFORMATION			
Type	Multi directional Outlet	Colour	White
Function	Supply Air	Material	ABS Polymer
Mount	Ceiling		Multi Directional

Multi Directional Outlet					
	Product Code	Nominal Neck Metric	Nominal Neck Imperial	Pieces/Carton	Price
	VMDO99	225 x 225	9 x 9	10	\$38.00
	VMDO1212	300 x 300	12 x 12	10	\$36.25
	*Non-glare mottled white finish				

## Reducing Neck for Multiflo

PRODUCT INFORMATION			
Type	Reducing Neck for Multiflo	Colour	Black
Design	Butterfly Damper at Rear	Material	ABS Polymer

Poly Reducing Necks - c/w Damper to suit MULTIFLO®					
	Product Code	Neck Size Metric	Neck Size Imperial	Spigot Size Metric	Price
	VMDO998	225 x 225	9 x 9	200	\$48.60
	VMDO12128	300 x 300	12 x 12	200	\$46.11
	VMDO121210	300 x 300	12 x 12	250	\$46.11
	VMDO121212	300 x 300	12 x 12	300	\$46.11
*All Reducing Necks are black as standard					

## Flanged Jet Difuser

PRODUCT INFORMATION			
Type	Flanged Jet Diffuser	Colour	White Powder Coat
Function	Supply Air	Material	Aluminium
Mount	Wall		Rotatable Core

Flanged Jet Diffuser					
	Product Code	Neck Size Metric	Height Metric	Face Size Metric	Price
	VJDF8W	200	165	266	\$142.53
	VJDF10W	250	165	322	\$152.73
	VJDF12W	300	180	365	\$203.66
	VJDF14W	350	220	425	\$254.52
	VJDF16W	400	210	470	\$307.05
*Grilles are aluminium powder coated white as standard					

## Egg Crate Round Diffuser

PRODUCT INFORMATION			
Type	EggCrate Round	Colour	White
Function	Supply or Exhaust Air	Mount	Ceiling or Wall
Material	Polymer	Design	Connection to duct

Egg Crate Round Diffuser					
	Product Code	Nominal Neck Metric	Nominal Neck Imperial	Face Size Metric	Price
	VREG6	150	6	235	\$46.81
	VREG8	200	8	285	\$52.06
	VREG10	250	10	305	\$62.55
	VREG12	300	12	355	\$77.95
*Grilles are aluminium powder coated white as standard					

## Louvre Grille

PRODUCT INFORMATION			
Type	Louvre Grille	Colour	White
Function	Exhaust or Intake Air	Mount	Ceiling or Wall
Material	ABS Polymer	Design	Connection to duct

Louvre Grille					
	Product Code	Nominal Neck Metric	Nominal Neck Imperial	Pieces/Carton	Price
	VLGF4	100	4	20	\$10.90
	VLGF5	125	5	20	\$13.69
	VLGF6	150	6	10	\$15.95
*Grilles are aluminium powder coated white as standard					

## Gravity Grille

PRODUCT INFORMATION			
Type	Gravity Grille	Colour	White
Function	Exhaust or Intake Air	Mount	Ceiling or Wall
Material	ABS Polymer	Design	Connection to duct

Gravity Grille					
	Product Code	Nominal Neck Metric	Nominal Neck Imperial	Pieces/Carton	Price
	VGG4	100	4	20	\$9.40
	VGG5	125	5	20	\$10.93
	VGG6	150	6	10	\$14.84
*Grilles are aluminium powder coated white as standard					

## Exhaust Metal Valve

PRODUCT INFORMATION			
Type	Round Valve	Colour	White Powdercoat
Function	Supply or Exhaust Air	Mount	Ceiling
Material	Steel	Design	Turn Adjustment

Exhaust Metal Valve					
	Product Code	Exact Neck Metric	Nominal Neck Imperial	Face Size Metric	Price
	VMVE4	100	4	140	\$19.05
	VMVE5	125	5	165	\$22.04
	VMVE6	150	6	200	\$33.87
	VMVE8	200	8	250	\$40.37
*Grilles are aluminium powder coated white as standard					

## Hinged EggCrate Grille with Filter

PRODUCT INFORMATION			
Type	Hinged EggCrate Grille	Colour	White Powdercoat
Function	Return or Exhaust Air	Mount	Ceiling or Wall
Material	Aluminium	Design	Hinged on Short Side

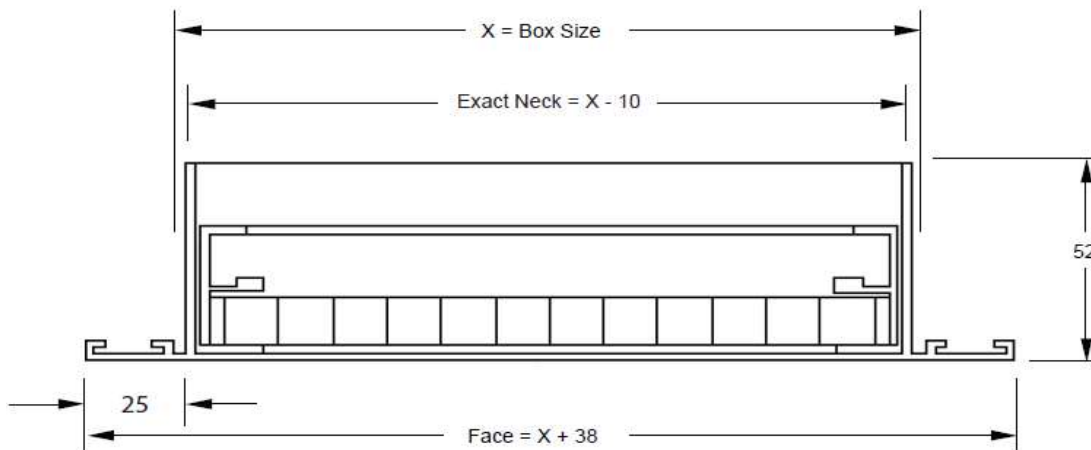

Hinged EggCrate Grille with Filter					
	Product Code	Nominal Neck Metric	Nominal Neck Imperial	Pieces/Carton	Price
	VECGF1212	300 x 300	12 x 12	2	\$53.84
	VECGF1612	400 x 300	16 x 12	2	\$83.87
	VECGF2412	600 x 300	24 x 12	2	\$98.72
	VECGF1414	350 x 350	14 x 14	2	\$72.15
	VECGF1616	400 x 400	16 x 16	2	\$72.15
	VECGF2016	500 x 400	20 x 16	2	\$92.74

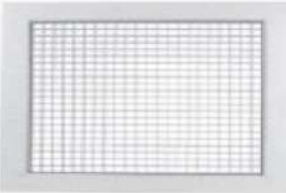
Hinged EggCrate Grille with Filter					
	Product Code	Nominal Neck Metric	Nominal Neck Imperial	Pieces/Carton	Price
		VECGF2416	600 x 400	24 x 16	2
VECGF2816		700 x 400	28 x 16	2	\$118.28
VECGF3016		750 x 400	30 x 16	2	\$124.51
VECGF3616		900 x 400	36 x 16	2	\$113.57
VECGF4016		1000 x 400	40 x 16	2	\$179.07
VECGF4816		1200 x 400	48 x 16	2	\$156.86
VECGF1818		450 x 450	18 x 18	2	\$81.84
VECGF2418		600 x 450	24 x 18	2	\$110.84
VECGF3018		750 x 450	30 x 18	2	\$127.98
VECGF3618		900 x 450	36 x 18	2	\$131.91
VECGF2020		500 x 500	20 x 20	2	\$94.05
VECGF2420		600 x 500	24 x 20	2	\$117.22
VECGF2820		700 x 500	28 x 20	2	\$124.51
VECGF3020		750 x 500	30 x 20	2	\$127.98
VECGF3220		800 x 500	32 x 20	2	\$153.41
VECGF3620		900 x 500	36 x 20	2	\$134.60
VECGF4020		1000 x 500	40 x 20	2	\$215.58
VECGF2422		600 x 550	24 x 22	2	\$135.63
VECGF2622		650 x 550	26 x 22	2	\$155.76
VECGF2822		700 x 550	28 x 22	2	\$146.30
VECGF3022		750 x 550	30 x 22	2	\$126.53
VECGF3622		900 x 550	36 x 22	2	\$156.14
VECGF2424		600 x 600	24 x 24	2	\$135.09
VECGF3024		750 x 600	30 x 24	2	\$164.43
VECGF3224		800 x 600	32 x 24	2	\$178.73
VECGF3624		900 x 600	36 x 24	2	\$170.76
VECGF4824		1200 x 600	48 x 24	2	\$204.57
VECGF3624		800 x 650	32 x 26	2	\$170.76
VECGF595595		595 x 595	550 x 50	2	\$99.61

## Round Aluminium EggCrate Grille

Round Aluminium EggCrate Grille					
	Product Code	Nominal Neck Metric	Nominal Neck Imperial	Face Size Metric	Price
		VREG6	150	6	205
VREG8		200	8	255	\$52.06
VREG10		250	10	305	\$62.55
VREG12		300	12	355	\$77.95

Ph: 02 9525 0970

Fax: 02 9540 2899

Email: orders@arrowsales.com.au

Please Note All Prices Are GST Exclusive

## Fixed Core EggCrate Grille

PRODUCT INFORMATION			
Type	Fixed EggCrate Grille	Colour	White Powdercoat
Function	Return or Exhaust Air	Mount	Ceiling or Wall
Material	Aluminium	Design	Fixed

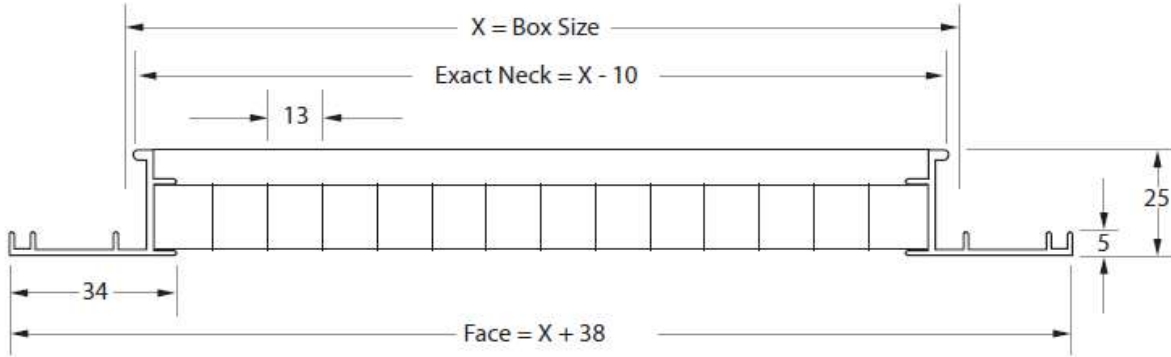

Fixed Core EggCrate Grille					
	Product Code	Nominal Neck Metric	Nominal Neck Imperial	Pieces/Carton	Price
	VEG66	150 x 150	6 x 6	40	\$26.09
	VEG88	200 x 200	8 x 8	20	\$30.03
	VEG99	225 x 225	9 x 9	10	\$36.19
	VEG1010	250 x 250	10 x 10	10	\$43.15
	VEG1212	300 x 300	12 x 12	10	\$53.88
	VEG2412	600 x 300	24 x 12	5	\$64.96
	VEG1414	350 x 350	14 x 14	10	\$67.50
	VEG1616	400 x 400	16 x 16	5	\$62.03
	VEG2424	600 x 600	24 x 24	5	\$102.28

## Fixed Core Layin EggCrate Grille

Fixed Core Layin EggCrate Grille					
	Product Code	Face Size Metric	Nominal Neck Metric	Pieces/Carton	Price
	VEG595295F	595 x 295	550 x 250	5	\$64.66
	VEG595595	595 x 595	550 x 250	5	\$103.58





## Fixed Core EggCrate Grille with Reducing Neck and Fixing Clip

Fixed Core EggCrate Grille with Reducing Neck and Fixing Clip					
	Product Code	Nominal Neck Metric	Nominal Neck Imperial	Spigot Size Metric	Price
	VEGN664	150 x 150	6 x 6	100	\$38.72
	VEGN665	150 x 150	6 x 6	125	\$38.72
	VEGN666	150 x 150	6 x 6	150	\$33.26
	VEGN886	200 x 200	8 x 8	150	\$40.08
	VEGN888	200 x 200	8 x 8	200	\$40.08
	VEGN10108	250 x 250	10 x 10	200	\$55.65
	VEGN101010	250 x 250	10 x 10	250	\$55.65
	VEGN12128	300 x 300	12 x 12	200	\$66.61
	VEGN121210	300 x 300	12 x 12	250	\$107.71
VEGN121212	300 x 300	12 x 12	300	\$66.61	

## Loose Core EggCrate Grille

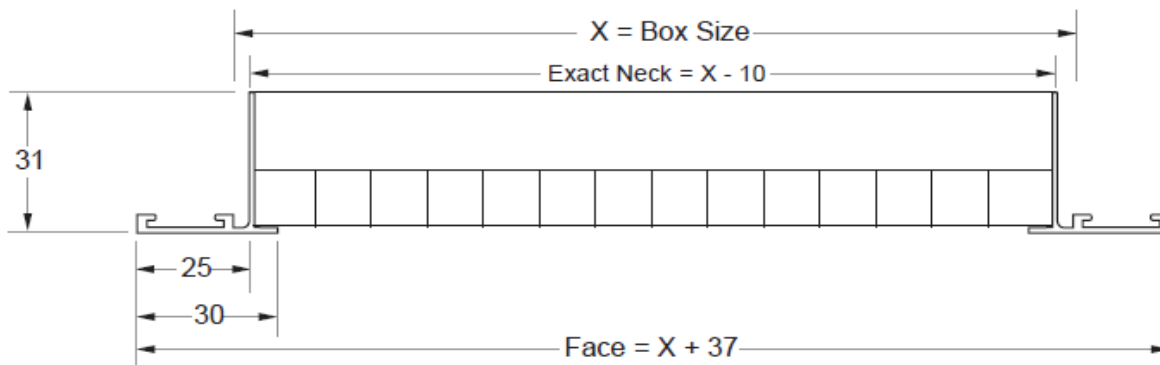
PRODUCT INFORMATION			
Type	Loose Core EggCrate Grille	Colour	White Powdercoat
Function	Return or Exhaust Air	Mount	Ceiling or Wall
Material	Aluminium	Design	Loose Core



Loose Core EggCrate Grille					
	Product Code	Nominal Neck Metric	Nominal Neck Imperial	Pieces/Carton	Price
	VEGLC1212	300 x 300	12 x 12	10	\$46.26
	VEGLC1616	400 x 400	16 x 16	5	\$86.40
	VEGLC2424	600 x 600	24 x 24	5	\$102.69

## Loose Core Lay-In EggCrate Grille

Loose Core Lay-In EggCrate Grille					
	Product Code	Face Size Metric	Nominal Neck Metric	Pieces/Carton	Price
	VEGLC595F	595 x 595	550 x 550	5	\$85.39

## Reducing Necks without clips for Lay-In Fixed and Loose Core EggCrate Grilles

Reducing Neck without Clips for Lay-In Fixed and Loose Core EggCrate Grilles					
	Product Code	Nominal Neck Metric	Nominal Neck Imperial	Spigot Size Imperial	Price
	VFFTBR200	550 x 550	22 x 22	8	\$24.71
	VFFTBR250	550 x 550	22 x 22	10	\$27.09
	VFFTBR300	550 x 550	22 x 22	12	\$24.71

## EggCrate Core Only

EggCrate Core Only					
	Product Code	Exact Size Metric	Finish	Pieces/Carton	Price
	VEGCC1195595	1220 x 1220	White	10	\$203.12

## Removable Core Bar Grille

PRODUCT INFORMATION			
Type	Removable Core Bar Grille	Colour	White Powdercoat
Function	Supply Air	Mount	Wall
Material	Aluminium	Design	Fixed Blades

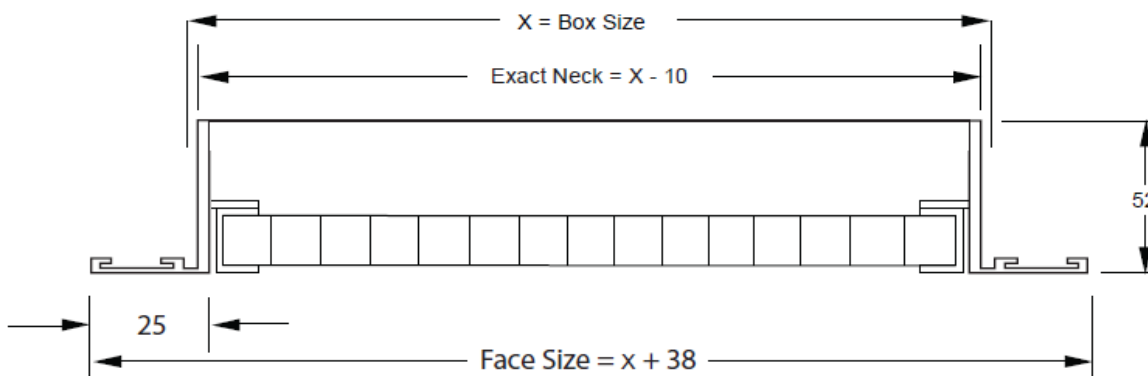

Removable Core Bar Grilles					
	Product Code	Nominal Neck Metric	Nominal Neck Metric	Pieces/Carton	Price
	VRCBG164	400 x 100	16 x 4	10	\$59.22
	VRCBG244	600 x 100	24 x 4	10	\$67.30
	VRCBG324	800 x 100	32 x 4	10	\$121.57
	VRCBG146	350 x 150	14 x 6	10	\$59.22
	VRCBG166	400 x 150	16 x 6	10	\$61.92
	VRCBG246	600 x 150	24 x 6	5	\$88.84

## Floor Grille

PRODUCT INFORMATION			
Type	Floor Grille	Colour	Natural Anodised
Function	Supply or Return Air	Mount	Aluminium
Material	Aluminium	Design	Fixed Core

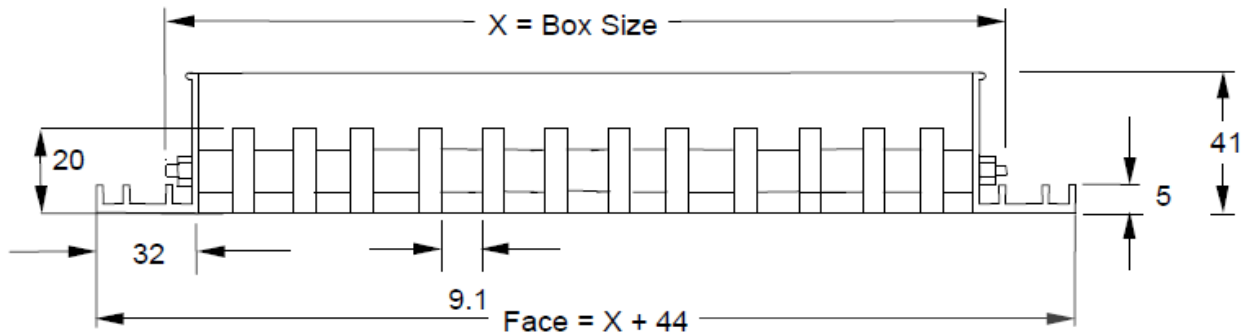



Floor Grille					
	Product Code	Nominal Neck Metric	Nominal Neck Imperial	Pieces/Carton	Price
	VMFG124B	300 x 100	12 x 4	10	\$101.40
	VMFG126N	300 x 150	12 x 6	10	\$102.98
	VMFG146N	350 x 150	14 x 6	10	\$143.19
	VMFG166N	400 x 150	16 x 6	10	\$146.16

## Schots Elite Vents

No. 7 Vent					
	Product Code	Description	Internal Size Metric	External Size Metric	Price
	VFGH7BN	Brush Nickel	355 x 145	380 x 185	\$119.74

No. 8 Vent					
	Product Code	Description	Internal Size Metric	External Size Metric	Price
	VFGH8OB	Oiled Bronze	350 x 150	400 x 200	\$119.74

No. 11 Vent					
	Product Code	Description	Internal Size Metric	External Size Metric	Price
	VFGH11BP	Brass Plated	300 x 100	345 x 145	\$84.94

No. 18 Vent					
	Product Code	Description	Int. Size	Ext. Size	Price
	VFGH18FB	Florintine Bronze	295 x 95	340 x 130	POA

## Door Grille

PRODUCT INFO			
Type	Door Grille	Colour	Anodised
Function	Air Relief	Mount	Door
Material	Aluminium	Design	Fixed Single Blades

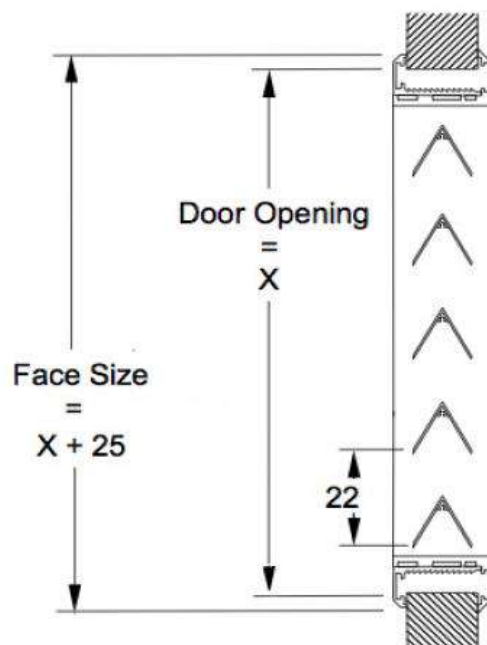



Door Grilles					
	Product Code	Nominal Neck Metric	Nominal Neck Imperial	Pieces/Carton	Price
	VDG126	300 x 150	12 x 6	10	\$56.03
	VDG186	450 x 150	18 x 6	10	\$62.00
	VDG244	600 x 100	24 x 4	10	\$77.52
	VDG246	600 x 150	24 x 6	10	\$70.09
	VDG248	600 x 200	24 x 8	10	\$123.49
	VDG1212	300 x 300	12 x 12	10	\$83.98
	VDG1818	450 x 450	18 x 18	10	\$134.43
	VDG2012	500 x 300	20 x 12	10	\$105.47
	VDG2410	600 x 250	24 x 10	10	\$88.10
	VDG2412	600 x 300	24 x 12	10	\$96.57
	VDG2416	600 x 400	24 x 16	10	\$121.63
	VDG2418	600 x 450	24 x 18	10	\$134.24
	VDG2424	600 x 600	24 x 24	10	\$270.00

## Removable Core Double Deflection Register

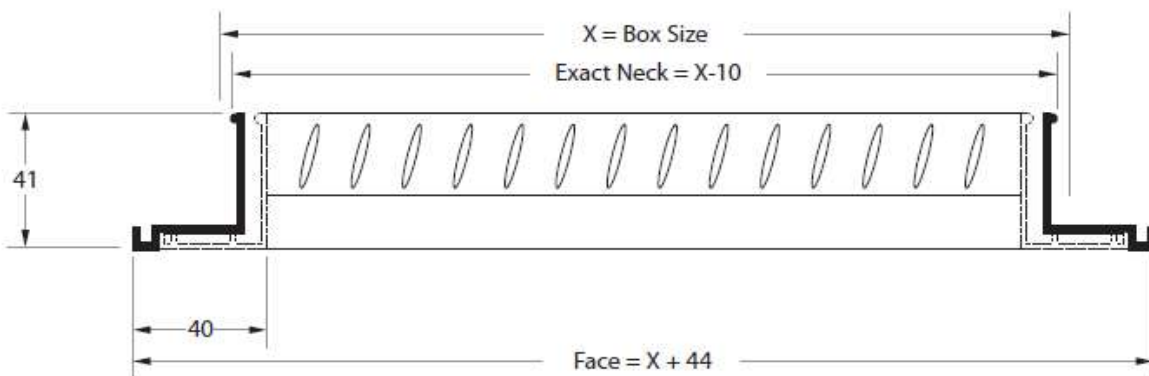
PRODUCT INFORMATION			
Type	Removable Double Deflection	Colour	White Powdercoat
Function	Supply Air	Mount	Wall or Duct
Material	Aluminium	Design	Adjustable Blades



Removable Core Double Deflection Register					
	Product Code	Nominal Neck Metric	Nominal Neck Imperial	Pieces/Carton	Price
	VSWR124RC	300 x 100	12 x 4	5	\$47.36
	VSWR144RC	350 x 100	14 x 4	5	\$52.52
	VSWR164RC	400 x 100	16 x 4	5	\$53.53
	VSWR184RC	450 x 100	18 x 4	5	\$69.34
	VSWR204RC	500 x 100	20 x 4	5	\$74.53
	VSWR244RC	600 x 100	24 x 4	5	\$74.76
	VSWR324RC	800 x 100	32 x 4	5	\$150.00

Removable Core Double Deflection Register					
	Product Code	Nominal Neck Metric	Nominal Neck Imperial	Pieces/Carton	Price
	VSWR126RC	300 x 150	12 x 6	5	\$49.42
	VSWR146RC	350 x 150	14 x 6	5	\$48.24
	VSWR166RC	400 x 150	16 x 6	5	\$53.10
	VSWR186RC	450 x 150	18 x 6	5	\$63.63
	VSWR206RC	500 x 150	20 x 6	5	\$71.28
	VSWR246RC	600 x 150	24 x 6	5	\$75.37
	VSWR128RC	300 x 200	12 x 8	5	\$55.83
	VSWR148RC	350 x 200	14 x 8	5	\$63.34
	VSWR168RC	400 x 200	16 x 8	5	\$61.04
	VSWR188RC	450 x 200	18 x 8	5	\$74.62
	VSWR208RC	500 x 200	20 x 8	5	\$85.09
	VSWR248RC	600 x 200	24 x 8	5	\$93.44
	VSWR1210RC	300 x 250	12 x 10	5	\$71.02
	VSWR2010RC	500 x 250	20 x 10	5	\$108.37
	VSWR2410RC	600 x 250	24 x 10	5	\$127.50
VSWR2412RC	600 x 300	24 x 12	5	\$127.98	

## Fixed Core Double Deflection Register

PRODUCT INFORMATION			
Type	Fixed Double Deflection	Colour	White Powdercoat
Function	Supply Air	Mount	Wall or Duct
Material	Aluminium	Design	Adjustable Blades

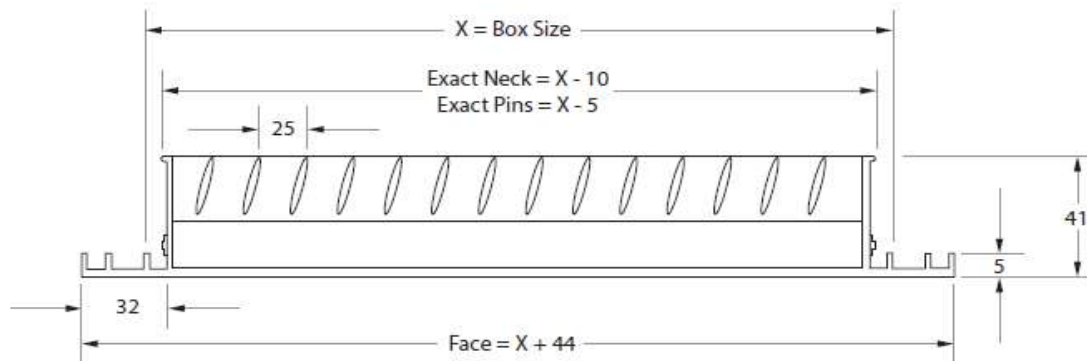

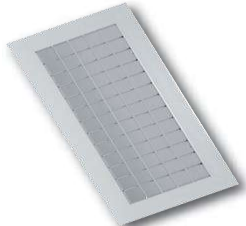
Fixed Core Double Deflection Register					
	Product Code	Nominal Neck (mm)	Nominal Neck Imperial	Pieces/Carton	Price
	VSWR104	200 x 100	8 x 4	5	\$38.72
	VSWR124	250 x 100	10 x 4	5	\$59.40
	VSWR144	300 x 100	12 x 4	5	\$43.94
	VSWR164	350 x 100	14 x 4	5	\$55.35
	VSWR184	400 x 100	16 x 4	5	\$52.43
	VSWR204	450 x 100	18 x 4	5	\$56.75
	VSWR244	500 x 100	20 x 4	5	\$62.99



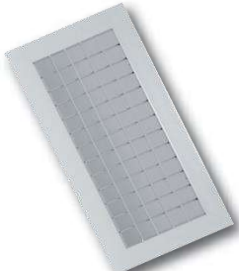

## Fixed Core Double Deflection Register

Fixed Core Double Deflection Register					
	Product Code	Nominal Neck Metric	Nominal Neck Imperial	Pieces/Carton	Price
	VSWR66	150 x 150	6 x 6	5	\$36.71
	VSWR86	200 x 150	8 x 6	5	\$37.15
	VSWR106	250 x 150	10 x 6	5	\$42.25
	VSWR126	300 x 150	12 x 6	5	\$41.59
	VSWR146	350 x 150	14 x 6	5	\$43.76
	VSWR166	400 x 150	16 x 6	5	\$49.39
	VSWR186	450 x 150	18 x 6	5	\$65.02
	VSWR206	500 x 150	20 x 6	5	\$68.26
	VSWR246	600 x 150	24 x 6	5	\$62.35
	VSWR306	750 x 150	30 x 6	5	\$104.20
	VSWR366	900 x 150	36 x 6	5	\$120.32
	VSWR88	200 x 200	8 x 8	5	\$40.66

## Weatherproof Louvre

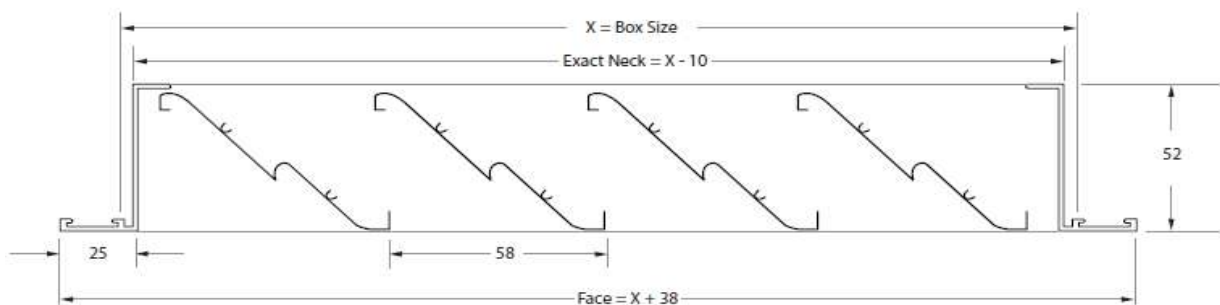
PRODUCT INFO			
Type	Weatherproof Louvre	Colour	Anodised
Function	Exhaust or air intake	Mount	Wall
Material	Aluminium	Design	48mm blade spacing



Weatherproof Louvre					
	Product Code	Nominal Neck Metric	Nominal Neck Imperial	Pieces/Carton	Price
	VOAL95	225 x 125	9 x 5	10	\$22.95
	VOAL66	150 x 150	9 x 6	10	\$29.15
	VOAL97	225 x 175	9 x 7	10	\$32.39
	VOAL88	200 x 200	8 x 8	10	\$30.45

## Weatherproof Louvre

Weatherproof Louvre					
	Product Code	Nominal Neck Metric	Nominal Neck Imperial	Pieces/Carton	Price
	VOAL168	400 x 200	16 x 8	10	\$70.44
	VOAL1010	250 x 250	10 x 10	10	\$81.00
	VOAL1212	300 x 300	12 x 12	10	\$60.26
	VOAL2412	600 x 300	24 x 12	10	\$132.21
	VOAL1414	350 x 350	14 x 14	10	\$78.53
	VOAL1616	400 x 400	16 x 16	10	\$98.92
	VOAL1818	450 x 450	18 x 18	5	\$118.03
	VOAL2020	500 x 500	20 x 20	5	\$137.14
	VOAL2424	600 x 600	24 x 24	5	\$154.69

## Return Air Boxes

Return Air Boxes			
	Product Code	Description	Price
	VRAB1195595216	1195x595 Insul Return Air Box-2x16	\$110.25
	VRAB161614	RAB 400 x 400 x 350	\$73.50
	VRAB181812	RAB 450 x 450 x 300	\$73.50
	VRAB181814	RAB 450 x 450 x 350	\$73.50
	VRAB241614	RAB 600 x 400 x 350	\$73.50
	VRAB241616	RAB 600 x 400 x 400	\$73.50
	VRAB2420214	RAB 600 x 500 x 2 off x 350	\$73.50
	VRAB2420216	RAB 600 x 500 x 2 off x 400	\$73.50
	VRAB242416	RAB 600 x 600 x 1off x 400	\$73.50
	VRAB2816214	RAB 700 x 500 x 2 off x 350	\$77.00
	VRAB2816216	RAB 700 x 500 x 2 off x 400	\$77.00
	VRAB301616	RAB 750 x 400 x 1 off 400	\$77.00
	VRAB3016214	RAB 750 x 400 x 2 off x 350	\$77.00
	VRAB3020214	RAB 750 x 500 x 2 off x 350	\$85.75
	VRAB3020216	RAB 750 x 500 x 2 off x 400	\$85.75
	VRAB30214	RAB 750 x 500 x 2 off x 350	\$85.75
	VRAB3022116	RAB 750 x 550 x 1 off x 400	\$85.75
	VRAB3022214	RAB 750 x 550 x 2 off x 350	\$85.75
	VRAB3022216	RAB 750 x 550 x 2 off x 400	\$85.75
	VRAB3616116	RAB 900 x 400 x 1 off x 400	\$85.75
	VRAB3616214	RAB 900 x 400 x 2 off x 350	\$85.75
	VRAB3616216	RAB 900 x 400 x 2 off x 400	\$85.75
	VRAB3620016	RAB 900 x 500 x 1 off x 400	\$85.75
	VRAB3620214	RAB 900 x 500 x 2 off x 350	\$85.75
	VRAB3620216	RAB 900 x 500 x 2 off x 400	\$85.75
	VRAB3622114	RAB 900 x 550 x 1 off x 350(14)	\$85.75
	VRAB3622116	RAB 900 x 550 x 1 off x 400	\$85.75
	VRAB3622214	RAB 900 x 550 x 2 off x 350(14)	\$85.75
	VRAB3622216	RAB 900 x 550 x 2 off x 400	\$85.75
	VRAB3624214	RAB 900 x 600 x 2 off x 350	\$85.75
VRAB3624216	RAB 900 x 600 x 2 off x 400	\$85.75	
VRAB4824216	RAB 1200 x 600 x 2 off x 400	\$110.25	
VRAB4824218	RAB 1200 x 600 x 2 off x 450	\$110.25	
VRAB59559516	Return Air Box 595x595 - 400(16)	\$73.50	

Supply Air Boxes			
	Product Code	Description	Price
	VVB1155245-12	Daikin V-Box 1155x250 -2x12sp	POA
	VVB1155245-14	Daikin V-Box 1155x250 -2x14sp	POA
	VVB1155245-16	Daikin V-Box 1155x250 -2x16sp	POA
	VVB1295320-14	Fujitsu V-Box 1295x316 -2x350sp	POA
	VVB855300-14	Fujitsu V-Box 855x300 -2x350sp	POA
	VVB855300-16	Fujitsu V-Box 855x300 -2x400sp	POA
	VVB925310-14	Fujitsu V-Box 925x310 -2x350sp	POA
	VVB925310-16	Fujitsu V-Box 925x310 -2x400sp	POA
	VVB1025265-12	Panasonic Vbox 1025x265 w 2 x12 sp	POA
	VVB1025335-14	Panasonic Vbox 1025x335 w 2 x14 sp	POA
	VVB1173225-14	Samsung V-Box 1170x225 - 2x350sp	POA
	VVB1270275-14	Samsung V-box 1270x275 - 2x350 sp	POA
	VVB1270275-16	Samsung V-box 1270x275 - 2x400 sp	POA
VVB823225-14	Samsung V-Box 823x225 - 2x350sp	POA	

UNI BOOT			
	Product Code	Description	Price
	VUB1246	Boots Uni 300 x 100 x 150	\$56.33
	VUB1248	Boots Uni 300 x 100 x 200	\$56.33
	VUB12610	Boots Uni 300 x 150 x 250	\$56.33
	VUB1268	Boots Uni 300 x 150 x 200	\$56.33
	VUB14610	Boots Uni 350 x 150 x 250	\$56.25
	VUB1468	Boots Uni 350 x 150 x 200	\$56.33
	VUB16410	Boots Uni 400 x 100 x 250	\$56.33
	VUB1648	Boots Uni 400 x 100 x 200	\$56.33
	VUB16610	Boots Uni 400 x 150 x 250	\$56.33
	VUB1668	Boots Uni 400 x 150 x 200	\$56.33
	VUB16812	Boots Uni 400 x 200 x 300	\$61.63

END BOOT			
	Product Code	Description	Price
	VUBE1246	Boots End 300 x 100 x 150	\$42.66
	VUBE1248	Boots End 300 x 100 x 200	\$48.36
	VUBE12610	Boots End 300 x 150 x 250	\$52.68
	VUBE1268	Boots End 300 x 150 x 200	\$52.68
	VUBE14610	Boots End 350 x 150 x 250	\$91.35
	VUBE1468	Boots End 350 x 150 x 200	\$51.51
	VUBE16410	Boots End 400 x 100 x 250	\$64.53
	VUBE1648	Boots End 400 x 100 x 200	\$64.53
	VUBE16610	Boots End 400 x 150 x 250	\$65.40
	VUBE1668	Boots End 400 x 150 x 200	\$65.40

Ph: 02 9525 0970

Fax: 02 9540 2899

Email: orders@arrowsales.com.au

Please Note All Prices Are GST Exclusive

SIDE BOOT			
	Product Code	Description	Price
	VUBS1246	Boots Side 300 x 100 x 150	\$61.97
	VUBS1248	Boots Side 300 x 100 x 200	\$61.97
	VUBS12610	Boots Side 300 x 150 x 250	\$61.97
	VUBS1268	Boots Side 300 x 150 x 200	\$61.97
	VUBS14610	Boots Side 350 x 150 x 250	\$61.97
	VUBS1468	Boots Side 350 x 150 x 200	\$75.87
	VUBS16410	Boots Side 400 x 100 x 250	\$61.97
	VUBS1648	Boots Side 400 x 100 x 200	\$61.97
	VUBS16610	Boots Side 400 x 150 x 250	\$61.97
	VUBS1668	Boots Side 400 x 150 x 200	\$61.97

## CUSTOM SHEET METAL

2-Way V-BOX				
	Product Code	Perimeter Range	Spigot	Price
	VVB2122300	0-2300	12"	POA
	VVB2142300	0 - 2300	14"	POA
	VVB2162300	0 - 2300	16"	POA
	VVB2122820	2301 - 2820	12	POA
	VVB2142820	2301 - 2820	14	POA
	VVB2162820	2301 - 2820	16	POA
	VVB2123500	2821 - 3500	12	POA
	VVB2143500	2821 - 3500	14	POA
	VVB2163500	2821 - 3500	16	POA

3-Way V-BOX			
	Product Code	Perimeter Range	Price
	VVB02300	0-2300	POA
	VVB02830	2301-2820	POA
	VVB03500	2821 -3500	POA

## CUSTOM SHEET METAL

Square To Round			
	Product Code	Perimeter Range	Price
	VCSSR02300	0 - 2300	\$129.00
	VCSSR02820	2301 - 2820	\$147.00
	VCSSR03500	2821 - 3500	\$189.60

Uni Boot Opposite Open End Spigot			
	Product Code	Perimeter Range	Price
	VUBM0800	0 - 800	POA
	VUBM8001200	800 - 1200	POA
	VUBM12011600	1201 - 1600	POA
	VUBM16012100	1601 - 2100	POA
	VUBM21012700	2101 - 2700	POA
	VUBM27013300	2701 - 3300	POA
	VUBM33013900	3301 - 3900	POA
	VUBM39015100	3901 - 5100	POA

End Boot Spigot On Short Side			
	Product Code	Perimeter Range	Price
	VCSCBS0800	0 - 800	POA
	VCSCBS1200	801 - 1200	POA
	VCSCBS1600	1201 - 1600	POA
	VCSCBS2100	1601 - 2100	POA
	VCSCBS2700	2101 - 2700	POA
	VCSCBS3300	2701 - 3300	POA
	VCSCBS3900	3301 - 3900	POA
	VCSCBS5100	3901 - 5100	POA

Side Boot Spigot On Long Side			
	Product Code	Perimeter Range	Price
	VCSCBS0800	0 - 800	POA
	VCSCBS01200	800 - 1200	POA
	VCSCBS01600	1201 - 1600	POA
	VCSCBS02100	1601 - 2100	POA
	VCSCBS02700	2101 - 2700	POA
	VCSCBS03300	2701 - 3300	POA
	VCSCBS03900	3301 - 3900	POA
	VCSCBS05100	3901 - 5100	POA



## CUSTOM SHEET METAL

Cushion Box 5mm Ruber - Low Profile (230 High)			
	Product Code	Size Metric	Price
	VCSCBL3052	305X305X-200	\$62.55
	VCSCBL3055	305X305-250	\$62.55
	VCSCVL3302	330X300-200	POA
	VCSCBL3305	330X330-250	\$68.10

Cushion Box Rubber Insulated				
	Product Code	Size Metric	Size Imperial	Price
	VCSCB1666	150X150-150	6x6-6	\$51.00
	VCSCB1886	200X200-150	8x8-6	\$58.95
	VCSCB1888	200X200-200	8x8-8	POA
	VCSCB1998	225X225-200	9x9-8	POA
	VCSCB110108	250X250-200	10x10-8	POA
	VCSCB1101010	250X250-250	10x10-10	POA
	VCSCB112128	300x300-200	12x12-8	POA
	VCSCB1121210	300x300-250	12x12-10	POA
	VCSCB1121212	300x300-300	12x12-12	POA
	VCSCB1151512	375x375-300	15x15-12	POA
	VCSCB1151514	375x375-350	15x15-14	POA
	VCSCB1181810	450x450-250	18x18-10	POA
	VCSCB1181812	450x450-300	18x18-12	POA
	VCSCB1181814	450x450-350	18x18-14	POA
	VCSCB1181816	450x450-400	18x18-16	POA
VCSCB1181818	450x450-450	18x18-18	POA	

Cushion Box Uninsulated Sprayed Black Inside				
	Product Code	Size Metric	Size Imperial	Price
	VCSCB066	150X150-150	6X6-6	POA
	VCSCB0886	200X200-150	8X8-6	\$44.55
	VCSCB0888	200X200-200	8X8-8	\$44.55
	VCSCB0998	225X225-200	9X9-8	POA
	VCSCB10108	250X250-200	10X10-8	\$75.00
	VCSCB101010	250X250-250	10X10-10	\$75.00

## CUSTOM SHEET METAL

### Cushion Box 25mm Black Fibre Glass Insulated

	Product Code	Size Metric	Size Imperial	Price
	VCSCB266	150X150-150	6x6-6	POA
	VCSCB2886	200X200-150	8x8-6	\$72.60
	VCSCB2888	200X200-200	8x8-8	\$79.35
	VCSCB2998	225X225-200	9x9-8	\$92.10
	VCSCB210108	250X250-200	10x10-8	\$101.10
	VCSCB210108	250X250-250	10x10-10	\$101.10
	VCSCB212128	300x300-200	12x12-8	\$107.10
	VCSCB21121210	300x300-250	12x12-10	POA
	VCSCB21121212	300x300-300	12x12-12	POA
	VCSCB21121212	375x375-300	15x15-14	POA
	VCSCB21181810	450x450-250	18x18-10	POA
	VCSCB21181812	450x450-300	18x18-12	POA
	VCSCB21181814	450x450-350	18x18-14	POA
	VCSCB21181816	450x450-400	18x18-16	POA
VCSCB21181818	450x450-450	18x18-18	POA	

### Return Air Boxes Plenums Top Entry

	Product Code	Perimeter Range	Price
	VRAB01600	0-1600	\$90.00
	VRAB02400	1601-2400	\$102.14
	VRAB02900	2401-2900	\$102.60
	VRAB03440	2901-3440	\$115.91
	VRAB03600	3441-3600	\$170.78

### Return Air Boxes Plenums + Fresh Air Spoigot

	Product Code	Perimeter Range	Price
	VRABF01600	0-1600	\$96.90
	VRABF02400	1601-2400	\$126.30
	VRAB02900	2401-2900	\$102.60
	VRABF03440	2901-3440	\$157.35
	VRABF03600	3441-3600	\$175.35

## Return Air Boxes Plenums Side Entry

	Product Code	Perimeter Range	Price
	VRABSE01600	0-1600	\$110.10
	VRABSE02400	1601-2400	\$158.55
	VRABSE02900	2401-2900	\$170.10
	VRABSE03440	2901-3440	\$210.30
	VRABSE03600	3441-3600	\$239.70

## Return Air Boxes Plenums Side Entry + Fresh Air Spoigot

	Product Code	Perimeter Range	Price
	VRABFAS01600	0-1600	\$130.05
	VRABFAS02400	1601-2400	\$174.00
	VRABFAS02900	2401-2900	POA
	VRABFAS03440	2901-3440	POA
	VRABFAS03600	3441-3600	\$247.95

## Return Air Boxes Plenums Side Entry + Filter Slide Door

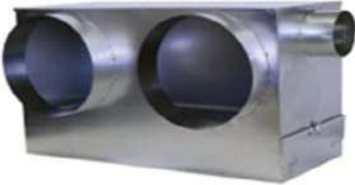
	Product Code	Perimeter Range	Price
	VRABFS01600	0-1600	\$219.00
	VRABFS02400	1601-2400	\$315.00
	VRABFS02900	2401-2900	\$338.25
	VRABFS03440	2901-3440	\$417.00
	VRABFS03600	3441-3600	\$474.00

## Drip Tray

	Product Code	Perimeter Range	Price
	VDTM03200	0 - 3200	POA
	VDTM32014400	3201 - 4400	POA
	VDTM44015600	4401 - 5600	POA

## Snap On Box for Weatherproof Louvre

PRODUCT INFO			
Type	Fitting	Colour	Black Powdercoated
Function	Exhaust or intake air	Mount	Wall
Material	Galvanised Saheet Metal	Design	Snap Fit

Snap On Box for Weatherproof Louvre					
	Product Code	Compatible Grilles	Size mm	Pieces/Carton	Price
	VOAL95B	VOAL95	225 x 125	18	\$23.56
	VOAL97B	VOAL97	225 x 175	18	\$20.61

**WE DELIVER**  
**SAVE TIME LET US COME TO YOU**



## BRANCH TAKE OFF

Fittings Branch Take Off Externally Sprayed Insulation Metal Construction				
	Nom. Size	Code	PICKUP	QTY
			\$/each	
	BTO 250x250x250	VPB101010	\$54.69	1
	BTO 250x250x200	VPB10108	\$47.16	1
	BTO 250x150x150	VPB1066	\$47.16	1
	BTO 250x200x150	VPB1086	\$42.96	1
	BTO 250x200x200	VPB1088	\$47.16	1
	BTO 300x250x250	VPB121010	\$54.69	1
	BTO 300x250x150	VPB12106	\$47.16	1
	BTO 300x250x200	VPB12108	\$45.87	1
	BTO 300x300x250	VPB121210	\$54.69	1
	BTO 300x300x300	VPB121212	\$56.67	1
	BTO 300x200x200	VPB1288	\$47.16	1
	BTO 350x250x250	VPB141010	\$55.29	1
	BTO 350x250x200	VPB14108	\$55.25	1
	BTO 350x300x250	VPB141210	\$57.69	1
	BTO 350x300x300	VPB141212	\$63.15	1
	BTO 350x300x200	VPB14128	\$54.69	1
	BTO 350x350x250	VPB141410	\$57.09	1
	BTO 350x350x300	VPB141412	\$62.34	1
	BTO 350x350x350	VPB141414	\$76.35	1
	BTO 350x350x200	VPB14148	\$57.09	1
	BTO 350x200x200	VPB1488	\$53.16	1
	BTO 400x250x250	VPB161010	\$56.91	1
	BTO 400x300x250	VPB161210	\$66.69	1
	BTO 400x300x300	VPB161212	\$66.69	1
	BTO 400x300x200	VPB16128	\$56.91	1
	BTO 400x350x250	VPB161410	\$59.40	1
	BTO 400x350x300	VPB161412	\$65.52	1
	BTO 400x350x350	VPB161414	\$93.60	1
	BTO 400x350x200	VPB16148	\$66.69	1
	BTO 400x400x250	VPB161610	\$59.40	1
	BTO 400x400x300	VPB161612	\$76.56	1
	BTO 400x400x350	VPB161614	\$84.21	1
	BTO 400x400x400	VPB161616	\$103.92	1
	BTO 400x400x200	VPB16168	\$59.40	1
	BTO 200x150x150	VPB866	\$42.96	1
	BTO 200x200x150	VPB886	\$47.25	1
	BTO 200x200x200	VPB888	\$47.16	1



## BRANCH TAKE OFF

Fittings Double Branch Take Off Externally Sprayed Insulation Metal Construction				
	Nom. Size	Code	PICKUP	QTY
			\$/each	
	250x250x200x200	VPDB101088	\$61.71	1
	250x200x150x150	VPDB10866	\$59.82	1
	250x200x200x200	VPDB10888	\$61.71	1
	300x250x250x250	VPDB12101010	\$67.32	1
	300x250x200x200	VPDB121088	\$61.71	1
	300x300x250x250	VPDB12121010	\$67.32	1
	300x300x250x200	VPDB1212108	\$61.71	1
	300x300x200x200	VPDB121288	\$67.20	1
	300x200x200x200	VPDB12888	\$61.71	1
	350x250x250x250	VPDB14101010	\$67.32	1
	350x250x200x200	VPDB141088	\$61.71	1
	350x300x250x250	VPDB14121010	\$67.32	1
	350x300x300x300	VPDB14121212	\$80.31	1
	350x350x250x250	VPDB14141010	\$67.32	1
	350x350x300x300	VPDB14141212	\$76.68	1
	350x350x200x200	VPDB141488	\$67.32	1
	350x200x200x200	VPDB14888	\$61.71	1
	400x250x250x250	VPDB16101010	\$80.46	1
	400x300x250x250	VPDB16121010	\$72.30	1
	400x300x300x300	VPDB16121212	\$80.46	1
	400x350x250x250	VPDB16141010	\$72.30	1
	400x350x300x300	VPDB16141212	\$85.95	1
	400x350x350x340	VPDB16141414	\$111.90	1
	400x350x200x200	VPDB161488	\$72.30	1
	400x400x250x250	VPDB16161010	\$80.46	1
	400x400x300x300	VPDB16161212	\$85.95	1
	200x150x150x150	VPDB8666	\$59.82	1

## Starting Collar

Starting Collar	Nom. Size	Code:	PICKUP	QTY
			\$/each	
	150	VSC6	\$11.46	1
	200	VSC8	\$12.12	1
	250	VSC10	\$13.40	1
	300	VSC12	\$15.17	1
	350	VSC14	\$17.26	1
	400	VSC16	\$18.24	1





## Y-PIECE

Fittings Branch Take Off Externally Sprayed Insulation Metal Construction				
	Nom. Size	Code:	PICKUP	
			\$/each	QTY
	250x250x250	VPY101010	\$41.25	1
	150x150x150	VPY1066	\$36.90	1
	250x200x200	VPY1088	\$37.50	1
	300x250x250	VPY121010	\$47.82	1
	300x300x300	VPY121212	\$48.69	1
	300x200x200	VPY1288	\$47.82	1
	350x250x250	VPY141010	\$53.82	1
	350x300x300	VPY141212	\$55.77	1
	350x200x200	VPY1488	\$53.13	1
	400x250x250	VPY161010	\$56.91	1
	400x300x300	VPY161212	\$67.77	1
	400x350x350	VPY161414	\$67.77	1
	400x400x400	VPY161616	\$79.71	1
	450x350x300	VPY181412	\$91.59	1
	450x350x350	VPY181414	\$107.79	1
	450x400x300	VPY181612	\$106.59	1
	450x400x350	VPY181614	\$109.59	1
	450x400x400	VPY181616	\$107.79	1
450x450x400	VPY181816	\$112.59	1	
	450x450x450	VPY181818	\$112.59	1
	500x400x400	VPY201616	\$128.70	1
	500x450x400	VPY201816	\$118.59	1
	150x150x150	VPY666	\$36.69	1
	Poly 150x150x150	VPY666P	\$21.05	1
	200x150x150	VPY866	\$36.69	1
	BTY 200x200x200	VPY888	\$36.69	1
	POLY 250x200x200	VPYP1088	\$33.64	1
	POLY 300x300x300	VPYP121212	\$53.26	1
	POLY 350x350x350	VPYP141414	\$59.74	1
	POLY 400x400x400	VPYP161616	\$70.77	1
	POLY 450x450x450	VPYP181818	\$83.70	1
	POLY 500x500x500	VPYP202020	\$105.93	1
POLY 200x150x150	VPYP866	\$29.70	1	

Semi Rigid Ducting	Nom. Size	Code:	PICKUP	
			\$/each	QTY
	100mm x 3m	VSRD100	\$45.68	1
	125mm x 3m	VSRD125	\$50.75	1
	150mm x 3m	VSRD150	\$55.83	1

## FITTINGS

Spun Spigots with dampers	Nom. Size	Code:	PICKUP	
			\$/each	QTY
	150	VSSD6	POA	1
	200	VSSD8	\$33.21	1
	250	VSSD10	\$39.01	1
	300	VSSD12	\$47.13	1
	350	VSSD14	\$54.52	1
	400	VSSD16	POA	1

Reducer	Nom. Size	Code:	PICKUP	
			\$/each	QTY
	200 - 150	VR86	\$32.94	1
	250 - 150	VR106	\$28.58	1
	250 - 200	VR108	\$33.90	1
	300 - 200	VR128	\$34.58	1
	300 - 250	VR1210	\$36.30	1
	350 - 250	VR1410	\$34.59	1
	350 - 300	VR1412	\$37.71	1
	400 - 300	VR1612	\$46.63	1
400 - 350	VR1614	\$41.10	1	

Line Dampers Externally Sprayed Insulation	Nom. Size	Code:	PICKUP	
			\$/each	QTY
	200	VLD8	POA	1
	250	VLD10	POA	1
	300	VLD12	POA	1
	350	VLD14	POA	1
	400	VLD16	POA	1
	450	VLD18	POA	1
	500	VLD20	POA	1

Manual dampers Externally Sprayed Insulation	Nom. Size	Code:	PICKUP	
			\$/each	QTY
	150	VMLD6	\$47.62	1
	200	VMLD8	\$56.97	1
	250	VMLD10	\$58.21	1
	300	VMLD12	\$56.35	1
	350	VMLD14	\$60.84	1
	400	VMLD16	\$66.64	1

## FITTINGS

Joiner	Nom. Size	Code:	PICKUP	
			\$/each	QTY
	150	VJC6	\$6.93	1
	200	VJC8	\$6.93	1
	250	VJC10	\$8.24	1
	300	VJC12	\$9.51	1
	350	VJC14	\$10.32	1
	400	VJC16	\$11.46	1
	450	VJC18	\$15.42	1
	500	VJC20	\$13.25	1

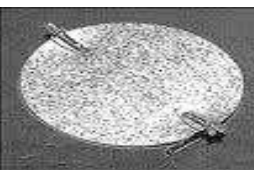
Damper Blade with Rapit Kits	Nom. Size	Code:	PICKUP	
			\$/each	QTY
	150	VDBK6	\$19.02	1
	200	VDBK8	\$19.02	1
	250	VDBK10	\$16.40	1
	300	VDBK12	\$19.02	1
	350	VDBK14	\$19.32	1
	400	VDBK16	\$21.09	1

Motorised Dampers Drive open/drive close motors Insulated	Nom. Size	Code:	PICKUP	
			\$/each	QTY
	250	VPZD10	\$78.30	1
	300	VPZD12	\$92.45	1
	350	VPZD14	\$100.47	1
	400	VPZD16	\$124.34	1

Inline Axial Fan	Nom. Size	Code:	PICKUP	
			\$/each	QTY
	150mm	FANAX150	\$95.00	1
	200mm	FANAX200	\$134.98	1
	250mm	FANAX250	\$287.38	1

Hanging Strap	Nom. Size	Code:	PICKUP	
			\$/each	QTY
	25mm x 50m	FS	POA	1

## VENTILATION PRODUCTS

DUCTWORK STRAPPING SUPPORT	Nom. Size	Code:	PICKUP	
			\$/each	QTY
	Blue Strapping 50m	FS	POA	1
	Steel Strapping 30kg	FS415M	\$19.17	1
	Steel Strapping 60kg	FS715M	\$30.88	1
Motorised	Nom. Size	Code:	PICKUP	
			\$/each	QTY
	200mm	VDZ200	\$113.74	1
	250mm	VDZ250	\$115.28	1
	300mm	VDZ300	\$116.81	1
	350mm	VDZ350	\$121.42	1
	400mm	VDZ400	\$122.96	1
Zone Air 24v Metal Motorised	Nom. Size	Code:	PICKUP	
			\$/each	QTY
	200mm	VDZ200	\$113.74	1
	250mm	VDZ250	\$115.28	1
	300mm	VDZ300	\$116.81	1
	350mm	VDZ350	\$121.42	1
	400mm	VDZ400	\$122.96	1
R1.5 Foilflex 4 Zero Glass	Nom. Size	Code:	PICKUP	
			\$/each	QTY
	250 x 6mtr	VR15FF4ZG106	\$88.97	1
	300 x 6mtr	VR15FF4ZG126	\$119.69	1
	350 x 6mtr	VR15FF4ZG146	\$148.37	1
	400 x 6mtr	VR15FF4ZG166	\$155.60	1
	450 x 6mtr	VR15FF4ZG186	\$148.81	1
	500 x 6mtr	VR15FF4ZG206	\$162.29	1
	150 x 6mtr	VR15FF4ZG66	\$65.26	1
	200 x 6mtr	VR15FF4ZG86	\$78.32	1
STANDARD DRIP TRAYS	Nom. Size	Code:	PICKUP	
			\$/each	QTY
	830 x 830	VDT8383	\$129.60	1
	1130 x 830	VDT11383	\$129.60	1
	1430 x 530	VDT14353	\$129.60	1
Slimline Axial Fan	Nom. Size	Code:	PICKUP	
			\$/each	QTY
	100mm	FANSL100	\$55.42	1

## VENTILATION PRODUCTS

Mixed Flow 2 Speed Fan	Nom. Size	Code:	PICKUP	
			\$/each	QTY
	100mm	FANMF100	\$158.33	1
	150mm	FANMF150	\$229.58	1
	200mm	FANMF200	\$316.67	1
	250mm	FANMF250	\$554.17	1
	315mm	FANMF315	\$672.92	1

## FLOW CONTROL

Drive open/close	Nom. Size	Code:	PICKUP	
			\$/each	QTY
	DA0216A	VDMPBW	POA	1
Spring return motors	Nom. Size	Code:	PICKUP	
			\$/each	QTY
	M447C1004	VDMS	POA	1
Cable	Nom. Size	Code:	PICKUP	
			\$/each	QTY
	10mtr	VDZCAB	POA	1
Touch Pad	Nom. Size	Code:	PICKUP	
			\$/each	QTY
	Touch Pad	VDZTP	\$78.30	1
Transformer	Nom. Size	Code:	PICKUP	
			\$/each	QTY
	Transformer	VDZTRANS	\$63.16	1
POLY MOTORISED DAMPERS	Nom. Size	Code:	PICKUP	
			\$/each	QTY
	200mm	VPZD8	\$78.00	1
	250mm	VPZD10	\$78.30	1
	300mm	VPZD12	\$92.45	1
	350mm	VPZD14	\$100.47	1
	400mm	VPZD16	\$124.34	1
Universal Remote	Code:	PICKUP		
		\$/each	QTY	
	VACUNI	POA	1	



## IZONE AIRCONDITIONING

### IZONE155 6 ZONE WIFI KITS & WIRELESS CONTROLLER

MODEL NO	DESCRIPTION	LIST PRICE
VDZIC155	NAKED - 8 ZONE ONLY + FOB KIT	POA
VDZIC155D	NAKED - 8 ZONE + DAIKIN + FOB KIT	\$889.34
VDZIC155F2	NAKED - 8 ZONE + FUJITSU + FOB KIT	\$889.34
VDZIC155H	NAKED - 8 ZONE + HITACHI + FOB KIT	\$889.34
VDZIC155HI	NAKED - 8 ZONE + HAIER + FOB KIT	\$889.34
VDZIC155L	NAKED - 8 ZONE + LG + FOB KIT	POA
VDZIC155M2	NAKED - 8 ZONE + MITSU ELECTRIC + FOB KIT	\$889.34
VDZIC155MD	NAKED - 8 ZONE + MIDEA + FOB KIT	\$889.34
VDZIC155MHI	NAKED - 8 ZONE + MHI + FOB KIT	\$889.34
VDZIC155P	NAKED - 8 ZONE + PANASONIC + FOB KIT	\$889.34
VDZIC155S	NAKED - 8 ZONE + SAMSUNG + FOB KIT	\$889.34
VDZIC155T	NAKED - 8 ZONE + TOSHIBA + FOB KIT	\$889.34
VDZIC155TZ	NAKED - 8 ZONE + TEMPERZONE + FOB KIT	\$889.34



CEPC

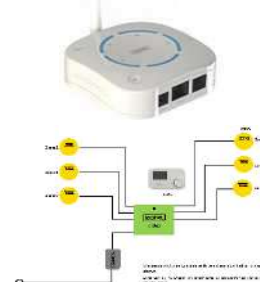

Naked kits include 1 x 8 zone CPU + 1 x Transformer + FOB or Bridge.

All Fujitsu 20kw and 25kw systems require an Intensis Box and a unique CPU, module and screen

### IZONE 415 8-16 ZONE NAKED KITS

MODEL NO	DESCRIPTION	LIST PRICE
VDZIC415D	NAKED - 8 ZONE + DAIKIN + WIFI KIT	\$1,242.20
VDZIC415F	NAKED - 8 ZONE + FUJITSU + WIFI KIT	\$1,242.20
VDZIC415H	NAKED - 8 ZONE + HITACHI + WIFI KIT	\$1,242.20
VDZIC415HI	NAKED - 8 ZONE + HAIER + WIFI KIT	\$1,242.20
VDZIC415M	NAKED - 8 ZONE + MITSU ELECTRIC + WIFI KIT	\$1,242.20
VDZIC415MD	NAKED - 8 ZONE + MIDEA + WIFI KIT	\$1,242.20
VDZIC415MHI	NAKED - 8 ZONE + MHI + WIFI KIT	\$1,242.20
VDZIC415P	NAKED - 8 ZONE + PANASONIC + WIFI KIT	\$1,242.20
VDZIC415S	NAKED - 8 ZONE + SAMSUNG + WIFI KIT	\$1,242.20
VDZIC415T	NAKED - 8 ZONE + TOSHIBA + WIFI KIT	\$1,242.20
VDZIC415TZ	NAKED - 8 ZONE + TEMPERZONE + WIFI KIT	\$1,242.20
VDZIC415Y	NAKED - 8 ZONE + YORK + WIFI KIT	\$1,242.20



[www.izoneilight.com.au](http://www.izoneilight.com.au)



## IZONE AIRCONDITIONING

### iZONE 420 NANO KITS

MODEL NO	DESCRIPTION	LIST PRICE
VDZIC420d	NANO + 8 ZONE + DAIKIN KIT	\$1,462.51
VDZIC420F	NANO + 8 ZONE + FUJITSU KIT	\$1,462.51
VDZIC420H	NANO + 8 ZONE + HITACHI KIT	\$1,462.51
VDZIC420HI	NANO + 8 ZONE + HAIER KIT	\$1,462.51
VDZIC420L	NANO + 8 ZONE + LG KIT	\$1,462.51
VDZIC420M	NANO + 8 ZONE + MITSU ELECTRIC KIT	\$1,462.51
VDZIC420MD	NANO + 8 ZONE + MIDEA KIT	\$1,462.51
VDZIC420MHI	NANO + 8 ZONE + MHI KIT	\$1,462.51
VDZIC420P	NANO + 8 ZONE + PANASONIC KIT	\$1,462.51
VDZIC420S	NANO + 8 ZONE + SAMSUNG KIT	\$1,462.51
VDZIC420T	NANO + 8 ZONE + TOSHIBA KIT	\$1,462.51
VDZIC420TZ	NANO + 8 ZONE + TEMPERZONE KIT	\$1,462.51
VDZIC420Y	NANO + 8 ZONE + YORK KIT	\$1,462.51



420 Nano kits include: 1 x Nano touch screen + 1 x RJ45 cable + 1 x 8 zone CPU + 1 x Transformer.  
Optional extras can be added to any kit such as: 6 zone extender, FOB, bridge, Nanos, Nexus, wireless sensors, iSense, iSave, iZone Lights, iZone Reticulation, Multiplexer and network extension module. See component parts below. All Fujitsu 20kw and 25kw systems require an Intensis Box and a unique CPU, module and screen.

### iZONE 425 NANO KITS

MODEL NO	DESCRIPTION	LIST PRICE
VDZIC425A	NANO + 8 ZONE + ACTRON + WIFI KIT	POA
VDZIC425D	NANO + 8 ZONE + DAIKIN + WIFI KIT	\$1,771.26
VDZIC425F	NANO + 8 ZONE + FUJITSU + WIFI KIT	\$1,771.26
VDZIC425H	NANO + 8 ZONE + HITACHI + WIFI KIT	\$1,771.26
VDZIC425HI	NANO + 8 ZONE + HAIER + WIFI KIT	\$1,771.26
VDZIC425Lg	NANO + 8 ZONE + LG + WIFI KIT	POA
VDZIC425M	NANO + 8 ZONE + MITSU ELECTRIC + WIFI KIT	\$1,771.26
VDZIC425MD	NANO + 8 ZONE + MIDEA + WIFI KIT	\$1,771.26
VDZIC425MHI	NANO + 8 ZONE + MHI + WIFI KIT	\$1,771.26
VDZIC425P	NANO + 8 ZONE + PANASONIC + WIFI KIT	\$1,771.26
VDZIC425S	NANO + 8 ZONE + SAMSUNG + WIFI KIT	\$1,771.26
VDZIC425T	NANO + 8 ZONE + TOSHIBA + WIFI KIT	\$1,771.26
VDZIC425TZ	NANO + 8 ZONE + TEMPERZONE + WIFI KIT	\$1,771.26
VDZIC425Y	NANO + 8 ZONE + YORK + WIFI KIT	\$1,771.26



## IZONE AIRCONDITIONING

### iZONE 430 NEXUS KITS

MODEL NO	DESCRIPTION	LIST PRICE
VDZIC430A	NEXUS + 8 ZONE + ACTRON KIT	POA
VDZIC430D	NEXUS + 8 ZONE + DAIKIN KIT	\$1,754.69
VDZIC430F	NEXUS + 8 ZONE + FUJITSU KIT	\$1,754.69
VDZIC430H	NEXUS + 8 ZONE + HITACHI KIT	\$1,754.69
VDZIC430HI	NEXUS + 8 ZONE + HAIER KIT	\$1,754.69
VDZIC430L	NEXUS + 8 ZONE + LG KIT	\$1,754.69
VDZIC430M	NEXUS + 8 ZONE + MITSU ELECTRIC KIT	\$1,754.69
VDZIC430MD	NEXUS + 8 ZONE + MIDEA KIT	\$1,754.69
VDZIC430MHI	NEXUS + 8 ZONE + MHI KIT	\$1,754.69
VDZIC430P	NEXUS + 8 ZONE + PANASONIC KIT	\$1,754.69
VDZIC430S	NEXUS + 8 ZONE + SAMSUNG KIT	\$1,754.69
VDZIC430T	NEXUS + 8 ZONE + TOSHIBA KIT	\$1,754.69
VDZIC430TZ	NEXUS + 8 ZONE + TEMPERZONE KIT	\$1,754.69
VDZIC430Y	NEXUS + 8 ZONE + YORK KIT	\$1,972.48

430 Nexus kits include: 1 x white Nexus touch screen (CCTSLW) + 1 x RJ45 cable + 1 x 8 zone CPU + 1 x Transformer. Optional extras can be added to any kit such as: 6 zone extender, FOB, bridge, Nanos, Nexus, wireless sensors, iSense, iSave, iZone Lights, iZone Reticulation, Multiplexer and network extension module. See component parts below.

Upgrade costs for other Nexus colours see "iZone Controllers". All Fujitsu 20kw and 25kw systems require an Intensis Box and a unique CPU, module and screen.

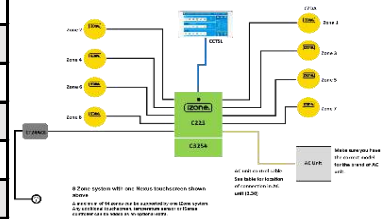

### iZONE 435 NEXUS KITS

MODEL NO	DESCRIPTION	LIST PRICE
VDZIC435A	NEXUS + 8 ZONE + ACTRON + WIFI KIT	POA
VDZIC435D	NEXUS + 8 ZONE + DAIKIN + WIFI KIT	\$1,972.48
VDZIC435F	NEXUS + 8 ZONE + FUJITSU + WIFI KIT	\$1,972.48
VDZIC435H	NEXUS + 8 ZONE + HITACHI + WIFI KIT	\$1,972.48
VDZIC435HI	NEXUS + 8 ZONE + HAIER + WIFI KIT	\$1,972.48
VDZIC435L	NEXUS + 8 ZONE + LG + WIFI KIT	\$1,972.48
VDZIC435M	NEXUS + 8 ZONE + MITSU ELECTRIC + WIFI KIT	\$1,972.48
VDZIC435MD	NEXUS + 8 ZONE + MIDEA + WIFI KIT	\$1,972.48
VDZIC435MHI	NEXUS + 8 ZONE + MHI + WIFI KIT	\$1,972.48
VDZIC435P	NEXUS + 8 ZONE + PANASONIC + WIFI KIT	\$1,972.48
VDZIC435S	NEXUS + 8 ZONE + SAMSUNG + WIFI KIT	\$1,972.48
VDZIC435T	NEXUS + 8 ZONE + TOSHIBA + WIFI KIT	\$1,972.48
VDZIC435TZ	NEXUS + 8 ZONE + TEMPERZONE + WIFI KIT	\$1,972.48
VDZIC435Y	NEXUS + 8 ZONE + YORK + WIFI KIT	\$1,972.48

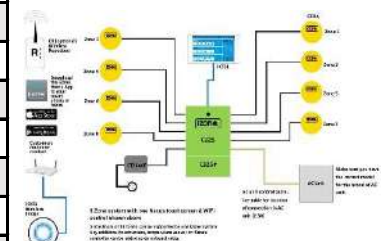

## IZONE AIRCONDITIONING

### IZONE WIRELESS SENSOR

MODEL NO	DESCRIPTION	LIST PRICE
VDZICRFSB	WIRELESS SENSOR BLACK	\$115.04
VDZICRFSW	WIRELESS SENSOR WHITE	\$115.04
VDZICRFSW	WIRELESS SENSOR OCEAN MIST	\$115.04



### IZONE WIRED SENSORS

MODEL NO	DESCRIPTION	LIST PRICE
VDZICWSMK	WIRED SENSOR MODULE KIT	\$243.00
VDZICSB	WIRED SENSOR BLACK	\$110.47
VDZICSW	WIRED SENSOR WHITE	\$110.47
VDZICSO	WIRED SENSOR OCEAN MIST	\$110.47
VDZICZCOB	ZONE CONTROLLER + ISENSE BLACK	\$331.34
VDZICZCOO	ZONE CONTROLLER + ISENSE OCEAN MIST	\$331.34
VDZICZCOW	ZONE CONTROLLER + ISENSE WHITE	\$331.34
VDZICDTS	IN DUCT SA TEMPERATURE SENSOR	\$24.11



### IZONE CONTROLLERS

MODEL NO	DESCRIPTION	LIST PRICE
VDZICCTSLW	NEXUS TOUCH SCREEN WHITE	\$939.07
VDZICCTSLB	NEXUS TOUCH SCREEN BLACK	\$939.07
VDZICCTSLS	NEXUS TOUCH SCREEN SILVER	\$939.07
VDZICCTSLG	NEXUS TOUCH SCREEN GOLD	\$939.07
VDZICCTSLBUG	NEXUS KIT UPGRADE - WHITE TO BLACK	\$54.48
VDZICCTSLSUG	NEXUS KIT UPGRADE - WHITE TO SILVER	POA
VDZICCTSLGUG	NEXUS KIT UPGRADE - WHITE TO GOLD	\$48.58
VDZICCTS	NANO COLOUR TOUCH SCREEN SILVER	\$803.42
VDZICCTSB	NANO COLOUR TOUCH SCREEN BLACK	\$803.42
VDZICCTSW	NANO COLOUR TOUCH SCREEN WHITE	\$803.42
VDZICCTSO	NANO KIT UPGRADE - WHITE TO GOLD	\$760.00
VDZICTSFB	NANO KIT UPGRADE - WHITE TO BLACK	\$24.50
VDZICTSFW	NANO KIT UPGRADE - WHITE TO SILVER	\$24.50
VDZICTSFO	NANO KIT UPGRADE - WHITE TO GOLD	\$24.50
VDZIC400FOB	400 NAKED ZONE FOB	\$150.45
VDZIC410FOB	410 NAKED ZONE + AC FOB	\$866.87
VDZIC100K	110 KIT	\$425.25
VDZIC110WC	110 WALL CONTROLLER	\$425.25
VDZIC110MC	110 MASTER CONTROLLER	\$425.25



## iZONE MODULES

MODEL NO	DESCRIPTION	LIST PRICE
VDZIC225	225 CPU MODULE	\$451.91
VDZIC325D	325 DAIKIN AC UNIT MODULE	\$ 162.50
VDZIC325F	325 FUJITSU AC UNIT MODULE	\$ 162.50
VDZIC325L	325 LG AC UNIT MODULE	\$ 162.50
VDZIC325M	325 MITSU ELECTRIC AC UNIT MODULE	\$ 162.50
VDZIC325P	325 PANASONIC AC UNIT MODULE	\$ 162.50
VDZIC325T	325 TOSHIBA AC UNIT MODULE	\$ 162.50
VDZIC325TZ	325 TEMPERZONE AC UNIT MODULE	\$ 162.50
VDZIC325H	325 HITACHI AC UNIT MODULE	\$ 162.50
VDZIC325MHI	325 MHI AC UNIT MODULE	\$ 162.50
VDZIC325S	325 SAMSUNG AC UNIT MODULE	\$ 162.50
VDZIC325HI	325 HAIER AC UNIT MODULE	\$ 162.50
VDZIC325Y	325 YORK AC UNIT MODULE	\$ 162.50
VDZICEXT	iZONE 6 ZONE EXTENDER	\$ 224.98
VDZICWSMK	WIRED SENSOR MODULE KIT	\$ 243.00
VDZICR	WIRELESS REPEATER	\$ 251.07
VDZICL5BK	iZONE WiFi BRIDGE	POA
VDZICUCMK	UNIVERSAL CONTROL MODULE	\$ 264.45
VDZICISMK	iZONE SYSTEM MULTIPLEXER KIT	\$ 517.83
VDZICNEMK	NETWORK EXTENSION KIT	\$ 619.30
VDZIC430K	NEXUS KIT - No bridge and no AC unit module	\$ 1972.48
VDZIC225K	NANO KIT - No bridge and no AC unit module	POA
VDZICINTEN	FUJITSU INTENSIS BOX (REQUIRED FOR ALL FUJITSU 20KW AND 25KW SYSTEMS)	\$ 600.00

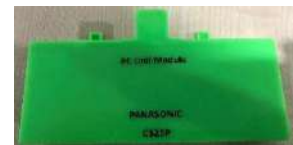

## iZONE SUNDRY COMPONENTS

MODEL NO	DESCRIPTION	LIST PRICE
VDZICFC1	1 METRE FLAT CAT 5E CABLE	\$11.80
VDZICFC12	12 METRE FLAT CAT 5E CABLE	\$ 45.90
VDZICFC25	25 METRE FLAT CAT 5E CABLE	\$ 87.21
VDZICDC12	12 METRE WHITE CABLE	\$ 28.11
VDZICDC25	25 METRE WHITE CABLE	\$ 70.24
VDZICGB2C35	AC UNIT TO IZONE CABLE FOR MIDEA UNITS. 1.5M LONG	\$ 172.57
VDZICDAK	ZONE DOUBLE ADAPTOR KIT	\$ 52.76
VDZICGB2C35	35 METRE CABLE FOR BRIDGE TO CPU	\$ 172.57
VDZICT24AC	TRANSFORMER 24V AC	\$ 126.21
VDZICR2032	CR2032 BATTERY	\$ 3.09
VDZICZDA	ZONE DAMPER ACTUATOR	\$ 64.24

Ph: 02 9525 0970

Fax: 02 9540 2899

Email: orders@arrowsales.com.au

Please Note All Prices Are GST Exclusive

## IZONE AIRCONDITIONING

### ZONE DAMPERS

MODEL NO	DESCRIPTION	LIST PRICE
VPZDIZ8	24V IZONE Dampers 200 Poly Motorised	POA
VPZDIZ10	24V IZONE Dampers 250 Poly Motorised	POA
VPZDIZ12	24V IZONE Dampers 300 Poly Motorised	POA
VPZDIZ14	24V IZONE Dampers 350 Poly Motorised	POA
VPZDIZ16	24V IZONE Dampers 400 Poly Motorised	POA
VPZDIZ18	24V IZONE Dampers 450 Poly Motorised	POA
VPZDIZCL08	IZONE CLIP IN LOW ZONE 200 PROFILE	POA
VPZDIZCL10	IZONE CLIP IN LOW ZONE 250 PROFILE	POA
VPZDIZCL12	IZONE CLIP IN LOW ZONE 300 PROFILE	POA
VPZDIZCL14	IZONE CLIP IN LOW ZONE 350 PROFILE	POA
VPZDIZCL16	IZONE CLIP IN LOW ZONE 400 PROFILE	POA
VDZICDC12	12m RJ12 Izone Green CABLE	\$28.11



### WIRELESS CONTROLLERS

MODEL NO	DESCRIPTION	LIST PRICE
VDZICACD	iZone Dimmer Switch Module	\$260.00
VDZICACR	Izone 240V 15A Wireless Relay Module	\$198.25
VDZICACRB	Izone 240V 5A Wireless Roller Blind	\$191.75
VDZICRFL1W	WIRELESS LIGHT SWITCH 1 BUTTON WHITE	\$182.73
VDZICRFL2W	WIRELESS LIGHT SWITCH 2 BUTTON WHITE	\$182.74
VDZICRFL3W	WIRELESS LIGHT SWITCH 3 BUTTON WHITE	\$182.74
VDZICRFLBAC	PRINTED SWITCH BUTTON (AC)	\$3.44
VDZICRFLBL	PRINTED SWITCH BUTTON (LIGHT)	\$3.44
VDZICRFLBOFF	PRINTED SWITCH BUTTON (ALL OFF)	\$3.44
VDZICRFLBON	PRINTED SWITCH BUTTON (ALL ON)	\$3.44



### CAMERA SECURITY

MODEL NO	DESCRIPTION	LIST PRICE
VDZICVD	iZONE SMART VIDEO DOORBELL	\$426.30
VDZICVDK	iZONE SMART VIDEO DOORBELL + 24VAC TRANSFORMER	\$479.61
VDZICVST	iZONE 24VAC TRANSFORMER FOR DOORBELL	\$26.46
VDZICIC	HVAC INDOOR CAMERA KIT	\$378.64





## IZONE AIRCONDITIONING



## LAMPS & DOWNLIGHTS

MODEL NO	DESCRIPTION	DISCOUNTED PRICE
<b>VDZICCLIGHT</b>		
VDZICL5B22	LAMP BAYONET BASE	\$151.71
VDZICL5E27	LAMP SCREW BASE	\$151.71
VDZICL5BS	DOWNLIGHT - WHITE	\$172.41
VDZICL5DB	DOWNLIGHT - SILVER	\$172.41
VDZICL5DW	DOWNLIGHT - BLACK	\$99.23

## SMART PLUG

MODEL NO	DESCRIPTION	DISCOUNTED PRICE
VDZICGPO	SMART POWER POINT	\$121.50



## GARAGE DOOR KIT

MODEL NO	DESCRIPTION	DISCOUNTED PRICE
VDZICGDK	SMART GARAGE DOOR CONTROLLER KIT	\$258.90



## SECURITY

MODEL NO	DESCRIPTION	DISCOUNTED PRICE
VDZICIC	WIRELESS REED SWITCH	\$378.64
VDIZLCVFR	VOLTAGE FREE RELAY FOR CGPO	POA

## iZONE GARDEN RETICULATION

MODEL NO	DESCRIPTION	DISCOUNTED PRICE
VDZICRCT	iZone Smart Irrigation System + Transformer	\$355.14
VDZICRCTK	iZone Smart Irrigation System +Transformer +Bridge	\$641.33



## POWER MONITORING

VDZICPMCT	CTS FOR POWER MONITORING	\$57.59
VDZICPMD	POWER MONITORING MODULE (EXCLUDES CTS)	\$129.77
VDZICPMK	WIRELESS POWER MONITORING KIT (3 CIRCUITS)	\$262.87







# **FASTENERS & SCREWS**

## Timber Screws

Self-Drilling Screws are suitable for fixing into timber and thin steel thicknesses of up to 0.6mm

### Selection Guide

#### Wafer Head

Suitable for jobs needing a low profile head, e.g. metal deck clips, electrical fittings, signs etc



#### Pan Head

Suitable for general fixing to Timber, e.g. brackets, fittings, etc



#### Countersunk Head

Suitable for jobs requiring a flush, finish, e.g. furniture, hinges, brackets, etc



#### Countersunk Rib Head

Suitable for jobs requiring a flush finish, e.g. furniture, flooring, etc



#### Bugle Head Batten

Rafters or fastening heavy timbers where a flush finish is required, e.g. fencing, furniture, pergolas, broadwalks, etc



#### Hexagon Head With Seal

Suitable for crest fixing roofing profiles to timbers battens and valley fixing wall cladding



#### Hexagon Head - No Seal



## Plasterboard Screws

Self Drilling Plasterboard Screws feature a bugle shaped head which countersinks neatly into plasterboard without crushing the core, or tearing the face paper. Available in a zinc-plated finish.

### Selection Guide

#### Bugle Head (Needle Point)

For general fixing to timber and thin steel up to 0.6mm thick, e.g. walls and ceilings, partitions, etc



#### Bugle Head (Metal Drill Point)

For fixing plasterboard to steel from 0.8mm to 2.5mm thickness



## Metal Screws

Self-Drilling Metal Screws have a hardened drill point and thread in structural and mild steel. These metal drill points are designed in a manner much the same as a high speed drill bit.

### Selection Guide

#### Wafer Head

Suitable for jobs needing a low profile head, e.g. metal deck clips, electrical fittings, signs, sheet metal, etc



#### Bugle Head

For fixing of plasterboard to metal



#### Button Head

Suitable for jobs needing a board flat head, e.g. foil sarking and insulation panels, fascia bracket clips to rafters, conduit clips to steel, etc



#### Countersunk Head

Suitable for jobs needing a flush finish, e.g. fencing, gates, hinges, etc



#### Countersunk Rib Head

Suitable for fixing pre-drilled board, e.g. panelling, lining board, etc



#### Pan Head

Suitable for general fixings, e.g. brackets, fixings, etc



#### Self Embedding Head

Suitable for general fixings to metal, e.g. lining boards, fascias, panelling, etc



#### Hexagon Head With Seal

Suitable for fixing roofing profiles and wall cladding to steel purlins



#### Hexagon Head - No Seal

Suitable for fixing metal e.g. fences, signs, fixings, trailers, etc



## Chipboard Screws

Zenith® self-drilling Chipboard screws have a coarse thread and fine shank to provide maximum grip and minimum stripout into chipboard, MDF board and soft timbers.

### Selection Guide



#### Countersunk Rib Head

Suitable for general fixing of chipboard, e.g., cabinets, furniture, kitchens, office partitioning etc. Available in 8 and 10 gauge. Lengths from 20mm to 100mm.

## Multi-Use Screws

Buildex® Multi-Use Screws are all-purpose self-drilling screws for general fixing around the home, into timber and thin metal. Available in a zinc-plated finish.

### Selection Guide

#### Button Head

Suitable for jobs where a broad, flat head is needed, e.g. shade cloth, foil insulation, wire mesh, clips, etc

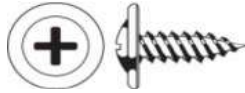

#### Pan Head

For general fixings, e.g., spotlights, doors, security alarms, light switches, wall phones, etc.



#### Bugle Head - Needle Point

Recommended for all general fixing into timber and light gauge metal, for applications where a countersunk head is required.



#### Countersunk Head

For attaching hinges



## Sleeve Anchors

The Sleeve Anchor is a general purpose medium duty anchor for fixing to concrete, masonry, solid and hollow brick and natural stone. The Sleeve Anchor is manufactured using carbon steel or 316 stainless steel.



### Selection Guide

#### Hex Head

## Wall Plugs

Plastic Wall Plug is a colour coded, light weight, low cost fixing combined with screws for fixing into solid masonry and is easy to install.



### Selection Guide

- White Wall Plug
- Red Wall Plug
- Green Wall Plug
- Blue Wall Plug

- Screw Gauge = 4 - 6
- Screw Gauge = 8 - 9
- Screw Gauge = 10 - 12



## Shuredrive

Shuredrive is an all metal nail expanding anchor for masonry and concrete



## Hollow Wall Anchor

Hollow Wall Anchors are all metal, pre-assembled fasteners for use in cavity walls. Suitable for light weight fixing to thin board



## Wallmates

Wallmates are self drilling plasterboard anchors, available in zinc or nylon and are suitable for attaching light weight fittings to hollow wall materials such as plasterboard, thin wall panelling and ceiling boards. It is ideal for hanging items such as paintings, picture frames, light weight brackets and fittings.

### Selection Guide

#### Zinc Wallmate



#### Nylon Wallmate



#### Nylon Wallmate (mini)



## Nylon Anchors

Nylon Anchors are a light duty nail expanding anchor for solid masonry and hollow wall constructions. The design of the expansion nail used in the Nylon Anchor is such that it can be removed if need be

### Selection Guide

#### Round Head



#### Countersunk Head



## Bolts & Thread Rod

### Selection Guide

#### Hex Round Bolt

Hexagon head bolts & nuts hold and join building materials used in framing structures. Typical applications include fixing metal to metal or metal to timber, e.g., heavy metal frames, metal posts, brackets, post supports, etc.



#### Cup Head Bolt

Cup head bolts & nuts hold and join building materials used in framing. Typical applications include fixing timber to timber, or timber to metal, e.g., heavy timber frames, pergolas, fencing, etc.



#### Coach Screw

For fixing to timber, Coach Screws are designed to form their own thread in pre-drilled holes. They have a Gimlet point for fast, easy penetration.

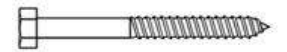





#### Threaded Rod

Threaded rod can be used in a variety of fixing applications.



## Fasteners - Anchors

DROP IN ANCHOR			Trade Price		Bulk Price		Stainless Steel		
			\$/each	Qty Pkt	\$/each	Qty Pkt	Code	\$/each	Qty Pkt
Product Details		Code							
	M6 Wedge / Drop-In Anchor	ANC0M06	\$0.47	50	\$0.26	100	ANC0SM06	\$1.78	50
	M8 Wedge / Drop-In Anchor	ANC0M08	\$0.53	50	\$0.31	100	ANC0SM08	\$3.11	50
	M10 Wedge / Drop-In Anchor	ANC0M10	\$0.79	25	\$0.38	50	ANC0SM10	\$3.73	25
	M12 Wedge / Drop-In Anchor	ANC0M12	\$1.22	25	\$0.78	50	ANC0SM12	\$6.43	25
	M16 Wedge / Drop-In Anchor	ANC0M16	\$2.44	10	\$1.56	25	ANC0SM16	\$16.21	10
	M20 Wedge / Drop-In Anchor	ANC0M20	\$4.12	10	\$3.12	25	POA		

SLEEVE ANCHOR			Trade Price		Bulk Price		Stainless Steel		
			\$/each	Qty Pkt	\$/each	Qty Pkt	Code	\$/each	Qty Pkt
Product Details		Code							
	Hex Sleeve Anchor M6.5 x 35mm	ACHSL6036	\$0.37	50	\$0.17	100	ANC6806036	\$1.24	50
	Hex Sleeve Anchor M6.5 x 55mm	ACHSL6055	\$0.43	50	\$0.22	100	ANC6806055	POA	50
	Hex Sleeve Anchor M6.5 x 75mm	ACHSL6075	\$0.35	50	\$0.00	100			
	Hex Sleeve Anchor M8 x 40mm	ACHSL8040	\$0.45	50	\$0.24	100	ANC6808040	\$1.47	50
	Hex Sleeve Anchor M8 x 65mm	ACHSL8065	\$0.70	25	\$0.30	50	ANC6808065	\$2.13	25
	Hex Sleeve Anchor M8 x 85mm	ACHSL8085	\$0.81	25	\$0.40	50	ANC6808085	\$2.54	25
	Hex Sleeve Anchor M10 x 40mm	ACHSL10040	\$0.80	25	\$0.39	50	ANC6810040	POA	25
	Hex Sleeve Anchor M10 x 50mm	ACHSL10050	\$0.87	25	\$0.46	50	ANC6810050	\$2.78	25
	Hex Sleeve Anchor M10 x 60mm	ACHSL10060	\$0.90	25	\$0.48	50	ANC6810060	POA	25
	Hex Sleeve Anchor M10 x 75mm	ACHSL10075	\$0.96	25	\$0.54	50	ANC6810075	\$3.51	25
	Hex Sleeve Anchor M10 x 95mm	ACHSL10095	\$1.45	25	\$0.64	50	ANC6810095	\$4.37	20
	Hex Sleeve Anchor M10 x 120mm	ACHSL10120	\$1.56	25	\$0.74	50			
	Hex Sleeve Anchor M12 x 60mm	ACHSL12060	\$1.58	25	\$0.76	50	ANC6812060	\$4.85	20
	Hex Sleeve Anchor M12 x 75mm	ACHSL12075	\$1.66	10	\$0.84	25	ANC6812075	\$5.19	20
	Hex Sleeve Anchor M12 x 100mm	ACHSL12100	\$2.09	10	\$1.06	25	ANC6812100	\$6.72	10
	Hex Sleeve Anchor M12 x 130mm	ACHSL12130	\$2.22	10	\$1.18	25			
	Hex Sleeve Anchor M16 x 65mm	ACHSL16065	\$2.28	10	\$1.24	25			
	Hex Sleeve Anchor M16 x 110mm	ACHSL16110	\$3.94	5	\$1.90	10			
	Hex Sleeve Anchor M16 x 145mm	ACHSL16145	\$4.37	5	\$2.30	10			
	Hex Sleeve Anchor M20 x 75mm	ACHSL20075	\$4.91	5	\$2.80	10			
	Hex Sleeve Anchor M20 x 105mm	ACHSL20105	\$7.24	5	\$3.20	10			
	Hex Sleeve Anchor M20 x 160mm	ACHSL20150	\$8.21	5	\$4.10	10			

HEX SLEEVE ANCHORS - Hot Dipped Galvanised			Trade Price		Bulk Price	
			\$/each	Qty Pkt	\$/each	Qty Pkt
Product Details		Code				
	Galvanised Hex Sleeve Anchor M8 x 40	ACHSG8040	\$0.54	25	\$0.33	50
	Galvanised Hex Sleeve Anchor M8 x 65	ACHSG8065	\$0.85	25	\$0.44	50
	Galvanised Hex Sleeve Anchor M8 x 80	ACHSG8080	\$0.92	25	\$0.50	50
	Galvanised Hex Sleeve Anchor M10 x 40	ACHSG10040	\$0.94	25	\$0.52	50
	Galvanised Hex Sleeve Anchor M10 x 50	ACHSG10050	\$1.00	25	\$0.58	50
	Galvanised Hex Sleeve Anchor M10 x 60	ACHSG10060	\$1.07	25	\$0.64	50
	Galvanised Hex Sleeve Anchor M10 x 80	ACHSG10080	\$1.13	25	\$0.70	50
	Galvanised Hex Sleeve Anchor M10 x 100	ACHSG10100	\$1.73	25	\$0.90	50
	Galvanised Hex Sleeve Anchor M12 x 60	ACHSG12060	\$1.84	25	\$1.00	50
	Galvanised Hex Sleeve Anchor M12 x 80	ACHSG12080	\$1.94	25	\$1.10	50
	Galvanised Hex Sleeve Anchor M12 x 100	ACHSG120100	\$2.37	25	\$1.32	50
	Galvanised Hex Sleeve Anchor M12 x 120	ACHSG120120	\$2.57	25	\$1.50	50

Mungo Frame Fixing		Code	Trade Price		Bulk Price	
			\$/each	Qty Pkt	\$/each	Qty Pkt
Product Details						
	Mungo Frame Fixing 10mm x 60mm Hex	MUF6	POA	50	POA	100
	Mungo Frame Fixing 10mm x 80mm Hex	MUF8	\$1.08	50	\$0.97	100
	Mungo Frame Fixing 10mm x 100mm Hex	MUF10	\$1.26	25	\$1.13	50
	Mungo Frame Fixing 10mm x 120mm Hex	MUF12	POA	25	POA	50
	Mungo Frame Fixing 10mm x 140mm Hex	MUF14	POA	25	POA	50

Ph: 02 9525 0970

Fax: 02 9540 2899

Email: orders@arrowsales.com.au

## Fasteners - Anchors

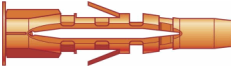
Mungo Nylon Multi Plug		Code	Trade Price		Bulk Price	
			\$/each	Qty Pkt	\$/each	Qty Pkt
	Product Details					
	Mungo Nylon Multi Plug 6mm x 35mm	MU6	\$0.47	50	\$0.26	100
	Mungo Nylon Multi Plug 8mm x 50mm	MU8	\$0.74	25	\$0.33	50
	Mungo Nylon Multi Plug 10mm x 60mm	MU10	\$1.36	10	\$0.56	25
	Mungo Nylon Multi Plug 12mm x 70mm	MU12	\$2.07	10	\$1.04	20
	Mungo Nylon Multi Plug 14mm x 75mm	MU14	\$3.37	5	\$1.37	10

HOLLOW WALL SET DROP-IN		Code	Trade Price		Bulk Price	
			\$/each	Qty Pkt	\$/each	Qty Pkt
	Product Details					
	Hollow Set Drop-In M10	ANCHSM10	\$3.92	50	\$3.08	100
	Hollow Set Drop-In M12	ANCHSM12	\$4.37	25	\$4.49	50

PVC Framed Wall Plugs		Code	Trade Price		Bulk Price	
			\$/100	Qty Pkt	\$/100	Qty Pkt
	Product Details					
	White 25mm PVC Framed Wall Plug	PLUG0525	\$0.08	500	\$0.06	1000
	White 38mm PVC Framed Wall Plug	PLUG0538	\$0.09	500	\$0.06	1000
	Green 25mm PVC Framed Wall Plug	PLUG0725	\$0.08	500	\$0.06	1000
	Green 30mm PVC Framed Wall Plug	PLUG0730	\$0.09	500	\$0.06	1000
	Green 38mm PVC Framed Wall Plug	PLUG0738	\$0.12	250	\$0.07	500
	Green 50mm PVC Framed Wall Plug	PLUG0750	\$0.12	250	\$0.08	500
	3m Roll Plastic Green Plugs	PLUGRLGREEN	\$6.40	1	\$0.00	1

Blue Tip Screw Bolt - Zinc Plated		Code	Trade Price		Bulk Price	
			\$/each	Qty Pkt	\$/each	Qty Pkt
	Product Details					
	Blue-Tip Screw-Bolt 5 x 50 Zn	ANCBT0550	POA	50	POA	100
	Blue-Tip Screw-Bolt 6.5 x 30 Zn	ANCBT0630	\$0.56	50	\$0.34	100
	Blue-Tip Screw-Bolt 6.5 x 50 Zn	ANCBT0650	\$0.71	50	\$0.48	100
	Blue-Tip Screw-Bolt 6.5 x 75 Zn	ANCBT0675	\$1.05	25	\$0.62	50
	Blue-Tip Screw-Bolt 6.5 x 100 Zn	ANCBT06100	\$1.26	25	\$0.81	50
	Blue-Tip Screw-Bolt 8 x 50 Zn	ANCBT0850	POA	25	POA	50
	Blue-Tip Screw-Bolt 8 x 75 Zn	ANCBT0875	\$1.69	25	\$1.22	50
	Blue-Tip Screw-Bolt 8 x 100 Zn	ANCBT08100	\$1.99	25	\$1.49	50
	Blue-Tip Screw-Bolt 10 x 60 Zn	ANCBT1060	\$1.84	25	\$1.35	50
	Blue-Tip Screw-Bolt 10 x 75 Zn	ANCBT1075	\$2.76	25	\$2.21	50
	Blue-Tip Screw-Bolt 10 x 100 Zn	ANCBT10100	\$3.09	25	\$2.51	50
	Blue-Tip Screw-Bolt 10 x 120 Zn	ANCBT10120	\$3.26	25	\$2.67	50
	Blue-Tip Screw-Bolt 12 x 75 Zn	ANCBT1275	\$3.72	25	\$3.09	50
	Blue-Tip Screw-Bolt 12 x 100 Zn	ANCBT12100	\$4.28	25	\$3.61	50
	Blue-Tip Screw-Bolt 12 x 150 Zn	ANCBT12150	\$5.64	10	\$4.87	25
	Blue-Tip Screw-Bolt 16 x 100 Zn	ANCBT16100	\$9.16	5	\$7.31	15
	Blue-Tip Screw-Bolt 16 x 150 Zn	ANCBT16150	\$10.91	5	\$8.94	15

Ph: 02 9525 0970

Fax: 02 9540 2899

Email: orders@arrowsales.com.au



## Fasteners - Anchors

Metal in Anchor		Code	Trade Price		Bulk Price	
Product Details			\$/each	Qty Pkt	\$/each	Qty Pkt
	Metal Pin Anchor M5 x 22	ANC1422	\$0.38	50	\$0.18	100
	Metal Pin Anchor M6.5 x 32	ANC1432	\$0.57	50	\$0.36	100
	Metal Pin Anchor M6.5 x 38	ANC1440	\$0.62	50	\$0.40	100
	Metal Pin Anchor M6.5 x 50	ANC1450	\$0.69	50	\$0.47	100

Hollow Wall Anchor		Code	Trade Price		Bulk Price	
Product Details			\$/each	Qty Pkt	\$/each	Qty Pkt
	6.5 Aluminium Hollow Wall	ANC09410	POA	50	POA	100
	Hollow Wall Anchor 1/8 (3-16mm)	ANCHW812	\$0.66	50	\$0.51	100

Metal Zip-It Drill Points		Code	Trade Price		Bulk Price	
Product Details			\$/each	Qty Pkt	\$/each	Qty Pkt
	Metal Zip-It Drill Point	ANC52WZ	POA	100	POA	100
	Zip-It Hollow Wall Fastener Nylon	ANZIPNY	\$0.20	50	\$0.17	100

Wall Dogs - Zinc Plated		Code	Trade Price		Bulk Price	
Product Details			\$/each	Qty Pkt	\$/each	Qty Pkt
	Wall Dog 32mm Pan Head Zinc	ANWD532	\$0.56	50	\$0.45	100
	Square Drive Wall Dog 32mm Pan Head	ANWDS532	\$0.82	50	\$0.80	100
	Square Drive Wall Dog 50mm Pan Head	ANWDS550	\$1.09	50	\$1.09	50
	Wall Dog 32mm Pan Head Zinc (500 pack)	ANWD532P	\$273.15	500	\$234.41	500

Drop In Anchors - Dynasets - Zinc Plated		Code	Trade Price		Bulk Price		Stainless Steel		
Product Details			\$/each	Qty Pkt	\$/each	Qty Pkt	Code	\$/each	Qty Pkt
	Nylon Anchor Round Head M5 x 25mm	ACHNYR525	\$0.29	50	\$0.10	100	ACHSR525	\$0.88	50
	Nylon Anchor Round Head M5 x 35mm		POA		POA		ACHSR535	\$0.69	50
	Nylon Anchor Round Head M5 x 40mm	ACHNYR540	\$0.33	50	\$0.13	100			
	Nylon Anchor Round Head M6.5 x 25mm	ACHNYR625	\$0.31	50	\$0.11	100	ACHSR626	\$0.88	50
	Nylon Anchor Round Head M6.5 x 40mm	ACHNYR640	\$0.36	50	\$0.16	100	ACHSR638	\$0.94	50
	Nylon Anchor Round Head M6.5 x 50mm	ACHNYR650	\$0.39	50	\$0.18	100			
	Nylon Anchor Round Head M6.5 x 75mm	ACHNYR675	\$0.27	25	\$0.00	50			

Nylon Anchor Mushroom Head		Code	Trade Price		Bulk Price	
Product Details			\$/100	Qty Pkt	\$/100	Qty Pkt
	Nylon Anchor Mushroom Head M5X25	ACHNYM525	\$29.75	50	\$10.05	100
	Nylon Anchor Mushroom Head M5X40	ACHNYM540	\$33.35	50	\$13.38	100
	Nylon Anchor Mushroom Head M6.5X25	ACHNYM625	\$31.91	50	\$12.05	100
	Nylon Anchor Mushroom Head M6.5X40	ACHNYM640	\$35.75	50	\$15.60	100
	Nylon Anchor Mushroom Head M6.5X50	ACHNYM650	\$37.18	50	\$16.93	100

Ph: 02 9525 0970

Fax: 02 9540 2899



Email: orders@arrowsales.com.au



## Fasteners - Anchors

Drive Spikes - Zinc Plated		Code	Trade Price		Bulk Price		Stainless Steel		
Product Details			\$/100	Qty Pkt	\$/100	Qty Pkt	Code	\$/each	Qty Pkt
	Mushroom Head Spike 5 x 25mm	ANCSPM525	\$71.46	50	\$64.00	100	ANCSPM525S	\$0.71	50
	Mushroom Head Spike 5 x 32mm	ANCSPM532	\$76.28	50	\$69.00	100	ANCSPM532S	\$0.76	50
	Mushroom Head Spike 5 x 38mm	ANCSPM538	\$78.32	50	\$71.00	100	ANCSPM538S	\$0.78	50
	Mushroom Head Spike 5 x 50mm	ANCSPM550	\$89.86	50	\$81.00	100	ANCSPM550S	\$0.90	50
	Mushroom Head Spike 6.5 x 25mm	ANCSPM625	\$91.30	50	\$82.00	100	ANCSPM625S	\$0.91	50
	Mushroom Head Spike 6.5 x 38mm	ANCSPM638	\$109.62	50	\$99.00	100	ANCSPM638S	\$1.10	50
	Mushroom Head Spike 6.5 x 50mm	ANCSPM650	\$121.68	50	\$101.00	100	ANCSPM650S	\$1.22	50
	Mushroom Head Spike 6.5 x 63mm	ANCSPM663	\$133.55	50	\$111.00	100	ANCSPM663S	\$1.34	10
	Mushroom Head Spike 6.5 x 75mm	ANCSPM675	\$156.33	50	\$130.00	100	ANCSPM675S	\$1.56	10
	Mushroom Head Spike 6.5 x 102mm	ANCSPM6102	\$201.06	50	\$181.00	100	ANCSPM6102S	\$2.01	10
	Countersunk Spike 5 x 65mm	ANCSPC565	\$115.13	50	\$104.00	100			
	Countersunk Spike 5 x 75mm	ANCSPC575	\$124.03	50	\$112.00	100			
	Countersunk Spike 5 x 100mm	ANCSPC5100	\$146.22	50	\$132.00	100			
	Countersunk Spike 6.5 x 38mm	ANCSPC638	\$105.70	50	\$95.00	100			
	Countersunk Spike 6.5 x 50mm	ANCSPC650	\$117.91	50	\$106.00	100			
	Countersunk Spike 6.5 x 65mm	ANCSPC665	\$136.26	50	\$123.00	100			
	Countersunk Spike 6.5 x 75mm	ANCSPC675	\$162.59	50	\$146.00	100			
	Countersunk Spike 6.5 x 100mm	ANCSPC6100	\$196.02	50	\$176.00	100			

Threaded Pipe Spikes - Zinc Plated		Code	Trade Price		Bulk Price	
Product Details			\$/100	Qty Pkt	\$/100	Qty Pkt
	Pipe Spike 5mm - 6mm Thread	PS56MM	\$211.33	50	\$211.00	100
	Pipe Spike 6.5mm - 8mm Thread	PS658MM	\$238.96	50	\$239.00	100
	Pipe Spike 6.5mm - 45mm M10	PS6510MM	\$238.96	50	\$239.00	100
	Pipe Dogleg Anc					

Kemfix Capsule Anchor - Zinc Plated		Code	Trade Price		Bulk Price	
Product Details			\$/each	Qty Pkt	\$/each	Qty Pkt
	Kemfix Capsule Anchor M8	ACHEM08	\$4.36	5	\$4.11	10
	Kemfix Capsule Anchor M10	ACHEM10	\$4.50	5	\$3.14	10
	Kemfix Capsule Anchor M12	ACHEM12	\$4.93	5	\$2.82	10
	Kemfix Capsule Anchor M16	ACHEM16	\$5.89	5	\$3.71	10
	Kemfix Capsule Anchor M20	ACHEM20	\$9.58	2	\$7.12	5
	Kemfix Capsule Anchor M24	ACHEM24	\$14.64	2	\$10.06	5

## Fasteners - Anchors

Hex Screw Anchor - Galvanized			Trade Price		Bulk Price	
			\$/each	Qty Pkt	\$/each	Qty Pkt
	Product Details	Code				
	HEX SCREW ANCHR HDG 6mmx50	ANCBTHG06050	\$0.71	50	\$0.49	100
	HEX SCREW ANCHR HDG 6mmx75	ANCBTHG06075	\$1.14	25	\$0.70	50
	HEX SCREW ANCHR HDG 6mmx100	ANCBTHG06100	\$1.34	25	\$0.89	50
	HEX SCREW ANCHR HDG 8mmx60	ANCBTHG08060	\$1.57	25	\$1.10	50
	HEX SCREW ANCHR HDG 8mmx75	ANCBTHG08075	\$1.89	25	\$1.40	50
	HEX SCREW ANCHR HDG 8mmx100	ANCBTHG08100	\$2.22	25	\$1.70	50
	HEX SCREW ANCHR HDG 10mmx60	ANCBTHG10060	\$2.11	25	\$1.60	50
	HEX SCREW ANCHR HDG 10mmx75	ANCBTHG10075	\$2.45	25	\$1.92	50
	HEX SCREW ANCHR HDG 10mmx100	ANCBTHG10100	\$3.19	25	\$2.60	50
	HEX SCREW ANCHR HDG 10mmx120	ANCBTHG10120	\$3.51	25	\$2.90	50
	HEX SCREW ANCHR HDG 12mmx75	ANCBTHG12075	\$3.81	25	\$3.17	50
	HEX SCREW ANCHR HDG 12mmx100	ANCBTHG12100	\$4.49	25	\$3.81	50

Wedge Bolt - Zinc Plated			Trade Price		Bulk Price	
			\$/each	Qty Pkt	\$/each	Qty Pkt
	Product Details	Code				
	ZYP WEDGE BOLT M10 X 65	ACHW10065	\$1.38	10	\$0.58	25
	ZYP WEDGE BOLT M10 X 75	ACHW10075	\$1.45	10	\$0.64	25
	ZYP WEDGE BOLT M10 X 90	ACHW10090	\$1.58	10	\$0.76	25
	ZYP WEDGE BOLT M10 X 120	ACHW10120	\$1.64	10	\$0.82	25
	ZYP WEDGE BOLT M12 X 80	ACHW12080	\$1.98	10	\$0.96	20
	ZYP WEDGE BOLT M12 X 100	ACHW12100	\$2.18	10	\$1.14	20
	ZYP WEDGE BOLT M12 X 140	ACHW12140	\$2.28	10	\$1.24	20
	ZYP WEDGE BOLT M8 X 80	ACHW8080	\$0.83	25	\$0.42	50
	ZYP WEDGE BOLT M8 X 100	ACHW8100	\$0.85	25	\$0.44	50
	ZYP WEDGE BOLT M8 X 120	ACHW8120	\$0.94	25	\$0.52	50

Wedge Bolt - Stainless Steel			Trade Price		Bulk Price	
			\$/each	Qty Pkt	\$/each	Qty Pkt
	Product Details	Code				
	SS316 WEDGE BOLT M10 X 90	ACHW10090S	\$3.72	10	\$2.74	25
	SS316 WEDGE BOLT M10 X 120	ACHW10120S	\$4.64	10	\$3.60	25
	SS316 WEDGE BOLT M12 X 80	ACHW12080S	\$5.48	10	\$4.20	20
	SS316 WEDGE BOLT M12 X 100	ACHW12100S	\$6.24	10	\$4.90	20
SS316 WEDGE BOLT M8 X 80	ACHW8080S	\$2.32	25	\$1.80	50	

Wedge Bolt - Galvanized			Trade Price		Bulk Price	
			\$/each	Qty Pkt	\$/each	Qty Pkt
	Product Details	Code				
	HDG WEDGE BOLT M10 X 65	ACHW10065HG	\$1.62	10	\$0.80	25
	HDG WEDGE BOLT M10 X 90	ACHW10090HG	\$1.94	10	\$1.10	25
	HDG WEDGE BOLT M10 X 120	ACHW10120HG	\$2.12	10	\$1.26	25
	HDG WEDGE BOLT M12 X 80	ACHW12080HG	\$2.41	10	\$1.36	20
	HDG WEDGE BOLT M12 X 100	ACHW12100HG	\$2.54	10	\$1.48	20
	HDG WEDGE BOLT M12 X 140	ACHW12140HG	\$3.00	10	\$1.90	20
	HDG WEDGE BOLT M8 X 80	ACHW8080HG	\$0.98	25	\$0.56	50
	HDG WEDGE BOLT M8 X 100	ACHW8100HG	\$1.07	25	\$0.64	50
	HDG WEDGE BOLT M8 X 120	ACHW8120HG	\$1.16	25	\$0.72	50

## Fasteners - Screws

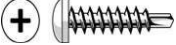

Pan Self tapping Screw - Zinc Plated			Trade Price		Bulk Price	
			\$/each	Qty Pkt	\$/each	Qty Pkt
	Product Details	Code				
	6gx32mm PAN SELF TAPPING SCREW	SKTSPZ0632	\$0.05	250	\$0.03	1000
	6gx50mm PAN SELF TAPPING SCREW	SKTSPZ0650	\$0.09	250	\$0.06	1000
	8gx32mm PAN SELF TAPPING SCREW	SKTSPZ0832	\$0.08	250	\$0.06	1000
	10gx32mm PAN SELF TAPPING SCREW	SKTSPZ1032	\$0.07	250	\$0.05	1000
	10gx50mm PAN SELF TAPPING SCREW	SKTSPZ1050	\$0.09	250	\$0.07	1000
	10gx75mm PAN SELF TAPPING SCREW	SKTSPZ1075	\$0.16	100	\$0.11	500



Pan Self Tapping Screw - Stainless Steel			Trade Price		Bulk Price	
			\$/each	Qty Pkt	\$/each	Qty Pkt
	Product Details	Code				
	10g x 25mm Pan S316 Tapping Screw	SKTSS16P10100	\$0.38	25	\$0.18	100
	10g x 32mm Pan S316 Tapping Screw	SKTSS16P10125	\$0.40	25	\$0.20	100
	6g x 32mm Pan S304 Tapping Screw	SKTSSP060125	\$0.20	50	\$0.10	200
	8g x 32mm Pan S304 Tapping Screw	SKTSSP080125	\$0.23	50	\$0.13	200
	10g x 32mm Pan S304 Tapping Screw	SKTSSP100125	\$0.36	25	\$0.16	100
	12G x 38mm Self Tapper Pan Head	SKTSSP120150	\$0.47	25	\$0.26	100

Countersunk Self Tapping Screw - Stainless Steel			Trade Price		Bulk Price	
			\$/each	Qty Pkt	\$/each	Qty Pkt
	Product Details	Code				
	304 STS CSK PHIL: #06 X 1/2	SKTSS0612	\$0.14	50	\$0.04	200
	304 STS CSK PHIL: #06 X 5/8	SKTSS0616	\$0.14	50	\$0.04	200
	304 STS CSK PHIL: #06 X 3/4	SKTSS0620	\$0.15	50	\$0.05	200
	304 STS CSK PHIL: #06 X 1	SKTSS0625	\$0.16	50	\$0.06	200
	304 STS CSK PHIL: #06 X 1-1/4	SKTSS0632	\$0.17	50	\$0.07	200
	304 STS CSK PHIL: #06 X 1-1/2	SKTSS0640	\$0.19	50	\$0.09	200
	304 STS CSK PHIL: #06 X 1-3/4	SKTSS0650	\$0.21	50	\$0.11	200
	304 STS CSK PHIL: #10 X 25mm	SKTSS1025	\$0.32	25	\$0.12	100
	304 STS CSK PHIL: #10 X 32mm	SKTSS1032	\$0.33	25	\$0.13	100
	304 STS CSK PHIL: #12 X 65mm	SKTSS1265	\$0.53	25	\$0.32	100

Countersunk Rib Head Screws - Zinc Plated			Trade Price		Bulk Price	
			\$/each	Qty Pkt	\$/each	Qty Pkt
	Product Details	Code				
	CSK Rib. Head (With Nibs) ZY 8-10x20mm	SDCY0820	\$0.04	250	\$0.02	1000
	CSK Rib. Head (With Nibs) ZY 8-10x25mm	SDCY0825	\$0.05	250	\$0.02	1000
	CSK Rib. Head (With Nibs) ZY 8-10x28mm	SDCY0830	\$0.05	250	\$0.03	1000
	CSK Rib. Head (With Nibs) ZY 8-10x32mm	SDCY0832	\$0.05	250	\$0.03	1000
	CSK Rib. Head (With Nibs) ZY 8-10x35mm	SDCY0835	\$0.06	250	\$0.03	1000
	CSK Rib. Head (With Nibs) ZY 8-10x41mm	SDCY0841	\$0.06	250	\$0.04	1000
	CSK Rib. Head (With Nibs) ZY 8-10x45mm	SDCY0845	\$0.06	250	\$0.04	1000
	CSK Rib. Head (With Nibs) ZY 8-10x50mm	SDCY0850	\$0.07	250	\$0.05	1000
	CSK Rib. Head (With Nibs) ZY 8-10x57mm	SDCY0857	\$0.07	250	\$0.05	1000
	CSK Rib. Head (With Nibs) ZY 8-10x65mm	SDCY0865	\$0.10	100	\$0.06	500
	CSK Rib. Head (With Nibs) ZY 10-8x100mm	SDCY10100	\$0.16	100	\$0.11	500
	CSK Rib. Head (With Nibs) ZY 10-8x40mm	SDCY1040	\$0.08	250	\$0.05	1000
	CSK Rib. Head (With Nibs) ZY 10-8x50mm	SDCY1050	\$0.09	250	\$0.07	1000
	CSK Rib. Head (With Nibs) ZY 10-8x65mm	SDCY1065	\$0.12	100	\$0.08	500
	CSK Rib. Head (With Nibs) ZY 10-8x75mm	SDCY1075	\$0.13	100	\$0.09	500

## Fasteners - Screws

Self Drilling Hex Coarse Screw - Class 4 - Galvanised		Code	Trade Price		Bulk Price	
Product Details			\$/100	Qty Pkt	\$/100	Qty Pkt
	SD Hex Coarse C4 8-18 x 12	SDSHG0812	\$7.21	1000	\$4.93	1000
	SD Hex Coarse C4 10-16 x 16	SDSHG1016	\$11.50	1000	\$8.90	1000
	SD Hex Coarse C4 10-16 x 22	SDSHG1022	\$10.64	1000	\$8.00	1000
	SD Hex Coarse C4 10-16 x 25	SDSHG1025	\$13.20	1000	\$10.48	1000
	SD Hex Coarse C4 12-14 x 20	SDSHG1220	\$15.36	1000	\$12.48	1000
	SD Hex Coarse C4 12-14 x 25	SDSHG1225	\$16.55	500	\$13.58	500
	SD Hex Coarse C4 12-14 x 35	SDSHG1235	\$19.68	500	\$16.48	500
	SD Hex Coarse C4 12-14 x 45	SDSHG1245	\$22.82	500	\$19.38	500
	SD Hex Coarse C4 12-14 x 55	SDSHG1255	\$25.72	500	\$20.00	500
	SD Hex Coarse C4 12-14 x 65	SDSHG1265	\$28.37	500	\$22.00	500
	SD Hex Coarse C3 12-14 x 75	SDSHG1275	\$33.25	250	\$26.00	250
	SD Hex Coarse C4 14-10 x 22	SDSHG1422	\$25.46	100	\$21.83	500
	SD Hex Coarse C4 14-10 x 25	SDSHG1425	\$27.41	50	\$23.63	250
	SD Hex Coarse C4 14-10 x 42	SDSHG1442	\$27.93	500	\$22.00	500
	SD Hex Coarse C4 14-10 x 50	SDSHG1450	\$31.48	100	\$24.00	500
	SD Hex Coarse C4 14-10 x 65	SDSHG1465	\$42.12	250	\$33.00	250
	SD Hex Coarse C4 14-10 x 75	SDSHG1475	\$45.22	250	\$35.00	250
	SD Hex Coarse C4 14-10 x 95	SDSHG1495	\$76.71	250	\$59.00	250

Self Drilling Hex Coarse Screw - Zinc Plated		Code	Trade Price		Bulk Price	
Product Details			\$/100	Qty Pkt	\$/100	Qty Pkt
	SD Hex Coarse ZY 8-18 x 12	SDSZ0812	\$5.24	200	\$3.10	1000
	SD Hex Coarse ZY 10-16 x 16	SDSZ1016	\$7.21	200	\$4.93	1000
	SD Hex Coarse Clear Zinc 10-16 x 16	SDSZ1016ZC	\$7.63	200	\$0.00	1000
	SD Hex Coarse ZY 10-16 x 22	SDSZ1022	\$7.18	200	\$4.00	1000
	SD Hex Coarse ZY 10-16 x 25	SDSZ1025	\$8.37	200	\$6.00	1000
	SD Hex Coarse ZY 12-14 x 20	SDSZ1220	\$8.68	500	\$0.00	500
	SD Hex Coarse ZY 12-14 x 25	SDSZ1225	\$9.75	500	\$7.00	500
	SD Hex Coarse ZY 12-14 x 30	SDSZ1230	\$10.32	200	\$7.00	1000
	SD Hex Coarse ZY 12-14 x 35	SDSZ1235	\$10.32	500	\$0.00	500
	SD Hex Coarse ZY 12-14 x 45	SDSZ1245	\$12.74	250	\$0.00	250
	SD Hex Coarse ZY 12-14X55	SDSZ1255	\$19.82	250	\$0.00	250
	SD Hex Coarse ZY 12-14X65	SDSZ1265	\$22.84	250	\$0.00	250
	SD Hex Coarse ZY 12-14X22	SDSZ1422	\$6.80	250	\$0.00	250

Self Drilling Hex Coarse Screw - Class 4 - With Neoprene		Code	Trade Price		Bulk Price	
Product Details			\$/100	Qty Pkt	\$/100	Qty Pkt
	SD Hex Coarse C4 8-18 x 12 Neo	SDSGNEO0812	\$11.02	1000	\$8.45	1000
	SD Hex Coarse C4 10-16 x 16 Neo	SDSGNEO1016	\$12.74	1000	\$10.05	1000
	SD Hex Coarse C4 10-16 x 25 Neo	SDSGNEO1025	\$15.36	1000	\$12.48	1000
	SD Hex Coarse C4 12-14 x 20 Neo	SDSGNEO1220	\$18.74	100	\$15.60	500
	SD Hex Coarse C4 12-14 x 35 Neo	SDSGNEO1235	\$23.06	200	\$19.60	1000
	SD Hex Coarse C4 12-14 x 45 Neo	SDSGNEO1245	\$24.52	200	\$20.95	1000
	SD Hex Coarse C4 12-14 x 55 Neo	SDSGNEO1255	\$33.21	200	\$19.00	1000
	SD Hex Coarse C4 12-14 x 65 Neo	SDSGNEO1265	\$29.06	200	\$28.00	1000
	SD Hex Coarse C4 12-14 x 75 Neo	SDSGNEO1275	\$34.91	100	\$29.00	500
	SD Hex Coarse C4 14-14 x 175 Neo	SDSGNEO14175	POA	500	POA	500
	SD Hex Coarse C4 14-10 x 20 Neo	SDSGNEO1420	\$27.41	250	\$23.63	250
	SD Hex Coarse C4 14-10 x 25 Neo	SDSGNEO1425	\$28.37	250	\$22.00	250
	SD Hex Coarse C4 14-10 x 42 Neo	SDSGNEO1442	\$31.04	250	\$24.00	250
	SD Hex Coarse C4 14-10 x 50 Neo	SDSGNEO1450	\$37.02	200	\$32.53	200
	SD Hex Coarse C4 14-10 x 65 Neo	SDSGNEO1465	\$39.42	500	\$39.42	500
	SD Hex Coarse C4 14-10 x 75 Neo	SDSGNEO1475	\$51.88	2,048	\$40.00	
	SD Hex Coarse C4 14-10 x 95 Neo	SDSGNEO1495	\$81.06	500	\$47.00	500

Ph: 02 9525 0970

Fax: 02 9540 2899







Email: orders@arrowsales.com.au

## Fasteners - Screws

Self Drilling Hex Fine Screw - Class 4 - Galvanised		Code	Trade Price		Bulk Price	
			\$/100	Qty Pkt	\$/100	Qty Pkt
	Product Details					
	SD Hex Fine C4 10-24 x 25	SDSF1025	POA	200	POA	1000
	250 - SD Hex Fine C4 12-24X30	SDSF10230	POA	200	POA	1000
	SD Hex Fine C4 12-24 x 30	SDSF10230	POA	100	POA	500
	260 - SD Hex Fine C4 14-20X115	SDSF14115	POA	50	POA	250
	SD Hex Fine C4 14-20 x 25	SDSF1425	POA	50	POA	250
	270 - SD Hex Fine C4 14-20X150	SDSF14150	POA	50	POA	250
	SD Hex Fine C4 14-20 x 115	SDSF14115	POA	50	POA	250
	SD Hex Fine C4 14-20 x 135	SDSF14135	POA	50	POA	250
	SD Hex Fine C4 14-20 x 150	SDSF14150	POA	50	POA	250



## Fasteners - Screws

Type 17 Hex Drive Screws - Zinc Plated		Code	Trade Price		Bulk Price	
Product Details			\$/100	Qty Pkt	\$/100	Qty Pkt
	T17 Hex Screw ZY 10-12 x 20	SK17ZY1020	\$12.40	1000	\$0.00	1000
	T17 Hex Screw ZY 10-12 x 25	SK17ZY1025	\$14.74	1000	\$0.00	1000
	T17 Hex Screw ZY 12-11 x 25	SK17ZY1225	\$9.79	500	\$0.00	500
	T17 Hex Screw ZY 12-11 x 35	SK17ZY1235	\$11.18	500	\$8.00	500
	T17 Hex Screw ZY 12-11 x 40	SK17ZY1240	\$10.89	500	\$0.00	500
	T17 Hex Screw ZY 12-11 x 45	SK17ZY1245	\$21.91	500	\$0.00	500
	T17 Hex Screw ZY 12-11 x 50	SK17ZY1250	\$11.22	1000	\$0.00	1000
	T17 Hex Screw ZY 12-11 x 65	SK17ZY1265	\$14.66	1000	\$14.66	1000
	T 17 Hex Screw ZY 14-10 x 25	SK17ZY1425	POA	1000	POA	1000
Type 17 Hex Drive Screws - Class 4 - Galvanised		Code	Trade Price		Bulk Price	
Product Details			\$/100	Qty Pkt	\$/100	Qty Pkt
	T17 Hex C4 10-12 x 25	SK17G1025	\$9.96	200	\$8.00	1000
	T17 Hex C4 12-11 x 25	SK17G1225	\$13.04	100	\$10.00	500
	T17 Hex C4 12-11 x 40	SK17G1240	\$17.20	200	\$14.00	1000
	T17 Hex C4 12-11 x 45	SK17G1245	\$15.77	200	\$13.00	1000
	T17 Hex C4 12-11 x 50	SK17G1250	\$17.06	200	\$14.00	1000
	T17 Hex C4 14-10 x 100	SK17G14100	\$46.49	100	\$36.00	500
	T17 Hex C4 14-10 x 115	SK17G14115	\$53.38	200	\$42.00	1000
	T17 Hex C4 14-10 x 125	SK17G14125	\$55.57	200	\$45.00	1000
	T17 Hex C4 14-10 x 150	SK17G14150	\$95.03	200	\$76.00	1000
	T17 Hex C4 14-10 x 25	SK17G1425	\$16.50	100	\$14.00	500
	T17 Hex C4 14-10 x 40	SK17G1440	\$18.31	100	\$15.00	500
	T17 Hex C4 14-10 x 50	SK17G1450	\$22.03	50	\$19.00	250
	T17 Hex C4 14-10 x 65	SK17G1465	\$30.81	50	\$25.00	250
	T17 Hex C4 14-10 x 75	SK17G1475	\$36.18	50	\$27.00	250
	T17 Hex C4 14-10 x 90	SK17G1490	\$40.42	50	\$34.00	250
Type 17 Hex Drive Screws - Class 4 - Galvanised With Neoprene		Code	Trade Price		Bulk Price	
Product Details			\$/100	Qty Pkt	\$/100	Qty Pkt
	T17 Hex C4 10-12 x 25 Neo	SK7GNEO1025	\$14.15	200	\$11.35	1000
	T17 Hex C4 12-11 x 25 Neo	SK7GNEO1225	\$19.17	100	\$16.00	500
	T17 HEX C3 12-11 x 35 Neo	SK7GNEO1235	\$22.36	200	\$18.95	1000
	T17 Hex C4 12-11 x 40 Neo	SK7GNEO1240	\$23.76	200	\$20.25	1000
	T17 Hex C4 12-11 x 45 Neo	SK7GNEO1245	\$20.90	200	\$17.60	1000
	T17 Hex C4 12-11 x 50 Neo	SK7GNEO1250	\$21.87	100	\$18.50	500
	T17 Hex C4 14-10 x 100 Neo	SK7GNEO14100	\$60.08	200	\$52.13	1000
	T17 Hex C4 14-10 x 115 Neo	SK7GNEO14115	\$72.36	200	\$60.00	1000
	T17 Hex C4 14-10 x 125 Neo	SK7GNEO14125	\$88.18	200	\$74.65	1000
	T17 Hex C4 14-10 x 150 Neo	SK7GNEO14150	\$99.71	100	\$85.33	500
	T17 Hex C4 14-10 x 25 Neo	SK7GNEO1425	\$26.68	100	\$22.95	500
	T17 Hex C4 14-10 x 40 Neo	SK7GNEO1440	\$23.57	50	\$23.00	250
	T17 Hex C4 14-10 x 50 Neo	SK7GNEO1450	\$38.23	50	\$33.65	250
	T17 Hex C4 14-10 x 65 Neo	SK7GNEO1465	\$40.58	50	\$34.08	250
	T17 Hex C4 14-10 x 75 Neo	SK7GNEO1475	\$42.04	50	\$35.43	250
	T17 Hex C4 14-10 x 90 Neo	SK7GNEO1490	\$53.46	50	\$46.00	250
Type 17 Self Embed Head Screw - Stainless Steel		Code	Trade Price		Bulk Price	
Product Details			\$/each	Qty Pkt	\$/each	Qty Pkt
	10-12X40mm TP 17 SELF EMBED Head	SK17SSE10040	\$0.25	250	\$0.21	1000
	10-12X50mm TP 17 SELF EMBED Head	SK17SSE10050	\$0.30	250	\$0.26	1000
	10-12X65mm TP 17 SELF EMBED Head	SK17SSE10065	\$0.44	100	\$0.38	500
	10-12X75mm TP 17 SELF EMBED Head	SK17SSE10075	\$0.51	100	\$0.43	500
	12-10X130mm TP 17 SELF EMBED Head	SK17SSE12130	\$1.33	50	\$1.16	250
	12-10X150mm TP 17 SELF EMBED Head	SK17SSE12150	\$1.89	50	\$1.68	250

Ph: 02 9525 0970

Fax: 02 9540 2899

Email: orders@arrowsales.com.au



## Fasteners - Screws

Type 17 Hex Drive Screw - Stainless Steel		Code	Trade Price		Bulk Price	
Product Details			\$/each	Qty Pkt	\$/each	Qty Pkt
	S/Steel Type 17 Hex 12-10X25	SK17SS1225	\$0.52	250.00	POA	1000
	S/Steel Type 17 Hex 12-10X50	SK17SS1250	\$0.58	250	\$0.52	1000
	S/Steel Type 17 Hex 12-10X65	SK17SS1265	\$0.86	100	\$0.78	500
	S/Steel Type 17 Hex 14-10X25	SK17SS1425	\$0.58	250	\$0.52	1000
	S/Steel Type 17 Hex 14-10X50	SK17SS1450	\$0.86	100	\$0.78	500
	S/Steel Type 17 Hex 14-10X65	SK17SS1465	\$0.94	100	\$0.84	500
	S/Steel Type 17 Hex 14-10X75	SK17SS1475	\$1.23	100	\$1.10	500
	S/Steel Type 17 Hex 14-10X90	SK17SS1490	\$1.35	50	\$1.22	250

Type 17 Hex Drive Screw - Stainless Steel with Neoprene		Code	Trade Price		Bulk Price	
Product Details			\$/each	Qty Pkt	\$/each	Qty Pkt
	S/Steel Type 17 Hex 12-10X25 Neo	SK17SSW1225	\$0.52	250	\$0.47	1000
	S/Steel Type 17 Hex 12-10X50 Neo	SK17SSW1250	\$0.72	250	\$0.65	1000
	S/Steel Type 17 Hex 12-10X65 Neo	SK17SSW1265	\$0.95	100	\$0.87	500
	S/Steel Type 17 Hex 12-14X25 Neo	SK17SSW1425	\$1.01	250	\$0.91	1000
	S/Steel Type 17 Hex 12-14X50 Neo	SK17SSW1450	\$1.02	100	\$0.93	500
	S/Steel Type 17 Hex 12-14X65 Neo	SK17SSW1465	\$1.18	100	\$1.05	500
	S/Steel Type 17 Hex 12-14X75 Neo	SK17SSW1475	\$1.23	100	\$1.10	500
	S/Steel Type 17 Hex 12-14X90 Neo	SK17SSW1490	\$1.38	100	\$1.25	500

Type 17 Bugle Batten - Stainless Steel		Code	Trade Price		Bulk Price	
Product Details			\$/each	Qty Pkt	\$/each	Qty Pkt
	14-10x50 TP 17 BUGLE BATTEN S304 HEX	SK17SSB14050	\$0.45	100	\$0.38	500
	14-10x65 TP 17 BUGLE BATTEN S304 HEX	SK17SSB14065	\$5.06	100	\$0.52	500
	14-10x50 TP 17 BUGLE BATTEN S316 SQ	SK17SSBQ14050	\$0.67	25	\$0.44	100
	14-10x65 TP 17 BUGLE BATTEN S316 SQ	SK17SSBQ14065	\$1.12	25	\$0.87	100
	14-10x75 TP 17 BUGLE BATTEN S316 SQ	SK17SSBQ14075	\$0.89	25	\$0.65	100

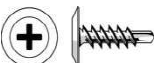
Self Drilling Button Head Screw - Class 3		Code	Trade Price		Bulk Price	
Product Details			\$/each	Qty Pkt	\$/each	Qty Pkt
	SD Button CLASS 3 8-18X12	SD23TG0812	\$0.06	250	\$0.04	1000
	SD Button CLASS 3 8-18X16	SD23TG0816	\$0.06	200	\$0.04	1000
	SD Button CLASS 3 8-18X20	SD23TG0820	\$0.08	200	\$0.06	1000
	SD Button CLASS 3 8-18X25	SD23TG0825	\$0.09	200	\$0.06	1000
	SD Button CLASS 3 8-18X32	SD23TG0832	\$0.10	200	\$0.07	1000
	SD Button CLASS 3 10-16X40	SD23TG1040	\$0.15		\$0.00	#N/A

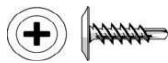
Self Drilling Button Head Screw - Zinc Plated		Code	Trade Price		Bulk Price	
Product Details			\$/100	Qty Pkt	\$/100	Qty Pkt
	SD Button ZY 8-18 x 12	SD23TB0812	\$4.81	250	\$2.92	1000
	SD Button Clear Zinc 8-18 x 12	SD23TB0812ZC	\$4.91	1000	\$5.00	1000
	SD Button ZY 8-18 x 16	SD23TB0816	\$5.35	200	\$3.46	1000
	SD Button ZY 8-18 x 20	SD23TB0820	\$5.75	200	\$3.86	1000
	SD Button ZY 8-18 x 25	SD23TB0825	\$5.97	200	\$4.08	1000
	SD Button ZY 8-18 x 32	SD23TB0832	\$7.21	200	\$5.32	1000
	SD Button ZY 10-18 x 16	SD23TB1016	\$5.08	200	\$3.00	1000

Ph: 02 9525 0970

Fax: 02 9540 2899

Email: orders@arrowsales.com.au

## Fasteners - Screws

TYPE 17 Bugle Batten - Zinc Plated		Code	Trade Price		Bulk Price	
Product Details			\$/100	Qty Pkt	\$/100	Qty Pkt
	T17 Bugle Batten ZY 14-10 x 50	SK7ZYB1450	\$23.33	1000	POA	1000
	T17 Bugle Batten ZY 14-10 x 65	SK7ZYB1465	\$29.81	1000	\$0.26	1000
	T17 Bugle Batten ZY 14-10 x 75	SK7ZYB1475	\$34.13	500	\$0.30	500
	T17 Bugle Batten ZY 14-10 x 100	SK7ZYB14100	\$47.76	500	\$0.37	500

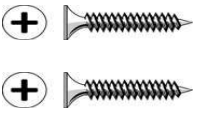
Bugle Screws - Fine Thread		Code	Trade Price		Bulk Price	
Product Details			\$/100	Qty Pkt	\$/100	Qty Pkt
	Needle Bugle Fine ZY 6-18 x 20	SK0B0620	\$4.19	200	\$2.13	1000
	Needle Bugle Fine ZY 6-18 x 25	SK0B0625	\$4.29	200	\$2.23	1000
	Needle Bugle Fine ZY 6-18 x 32	SK0B0632	\$5.02	200	\$2.90	1000
	Needle Bugle Fine ZY 6-18 x 35	SK0B0635	#N/A	200	POA	1000
	Needle Bugle Fine ZY 6-18 x 41	SK0B0641	\$5.24	200	\$3.10	1000
	Needle Bugle Fine ZY 6-18 x 45	SK0B0645	\$5.51	100	\$3.35	1000
	Needle Bugle Fine ZY 7-16 x 50	SK0B0750	\$6.21	100	\$4.00	1000
	Needle Bugle Fine ZY 8-16 x 50	SK0B0850	#N/A	100	POA	1000
	Needle Bugle Fine ZY 8-15 x 75	SK0B0875	\$9.61	50	\$7.15	1000
	Needle Bugle Fine ZY 10-15 x 100	SK0B10100	\$17.01	50	\$12.25	1000

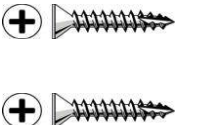
Bugle Screws - Coarse Thread		Code	Trade Price		Bulk Price	
Product Details			\$/100	Qty Pkt	\$/100	Qty Pkt
	Bugle Coarse ZY 6-9 x 20mm	SK9B20	\$4.29	200	\$2.23	1000
	Bugle Coarse ZY 6-9 x 25mm	SK9B25	\$4.54	200	\$2.45	1000
	Bugle Coarse ZY 6-9 x 32mm	SK9B32	\$5.02	200	\$2.90	1000
	Bugle Coarse ZY 6-9 x 45mm	SK9B45	\$5.51	100	\$3.35	1000
	Bugle Coarse ZY 8-10 x 50mm	SK9B50	\$6.10	100	\$3.90	1000
	Bugle Coarse ZY 8-10 x 65mm	SK9B65	\$6.62	100	\$5.00	1000

Button Head Needle Point		Code	Trade Price		Bulk Price	
Product Details			\$/100	Qty Pkt	\$/100	Qty Pkt
	Needle Button ZY 8-15 x 12	SK21BB13	\$5.13	200	\$3.00	1000
	Needle Button ZY 8-15 x 15	SK21BB16	\$5.51	200	\$3.35	1000
	Needle Button ZY 8-15 x 20	SK21BB20	\$5.75	200	\$3.58	1000
	Needle Button ZY 8-15 x 25	SK21BB25	\$6.48	200	\$4.25	1000
	Needle Button ZY 8-15 x 32	SK21BB32	\$6.70	200	\$4.45	1000
	Needle Button ZY 8-15 x 40	SK21BB40	\$7.21	100	\$4.93	1000
	Needle Button CLASS 3 8-15 x 12	SK21BG12	\$6.48	100	\$4.25	1000
	Needle Button CLASS 3 8-15 x 15	SK21BG15	\$6.86	100	\$4.60	1000
	Needle Button CLASS 3 8-15 x 20	SK21BG20	\$7.91	100	\$5.58	1000
	Needle Button CLASS 3 8-15 x 25	SK21BG25	\$8.15	100	\$5.80	1000
	Needle Button CLASS 3 8-15 x 30	SK21BG30	\$9.61	100	\$7.15	1000

Ph: 02 9525 0970

Fax: 02 9540 2899

Email: orders@arrowsales.com.au

## Fasteners - Screws

Coach Bolts - Hot Dipped Galvanised		Code	Trade Price		Bulk Price	
			\$/100	Qty Pkt	\$/100	Qty Pkt
	Product Details					
	HDG AS1393 4.6 Coach:M8 x 40	SKC08040	\$68.47	50	\$45.90	100
	HDG AS1393 4.6 Coach:M8 x 50	SKC08050	\$74.17	50	\$51.18	100
	HDG AS1393 4.6 Coach:M8 x 65	SKC08065	\$82.57	50	\$58.95	100
	HDG AS1393 4.6 Coach:M8 x 75	SKC08075	\$85.59	50	\$61.75	100
	HDG AS1393 4.6 Coach:M10 x 40	SKC10040	\$68.47	50	\$45.90	100
	HDG AS1393 4.6 Coach:M10 x 50	SKC10050	\$79.65	50	\$56.25	100
	HDG AS1393 4.6 Coach:M10 x 65	SKC10065	\$85.08	50	\$61.28	100
	HDG AS1393 4.6 Coach:M10 x 75	SKC10075	\$87.78	50	\$63.78	100
	HDG AS1393 4.6 Coach:M12 x 40	SKC12040	\$148.45	50	\$67.45	100
	HDG AS1393 4.6 Coach:M12 x 75	SKC12075	\$175.23	50	\$92.25	100
	HDG AS1393 4.6 Coach:M12 x 90	SKC12090	\$182.17	50	\$98.68	100
HDG AS1393 4.6 Coach:M12 x 100	SKC12100	\$199.75	50	\$114.95	100	

Hex Washer Face Head Self Drilling - Stainless Steel		Code	Trade Price		Bulk Price	
			\$/100	Qty Pkt	\$/100	Qty Pkt
	Product Details					
	SD Hex Coarse SS 10-16 x 16	SDS1016S	\$94.23	200	\$83.75	1000
	SD Hex Coarse SS 10-16 x 25	SDS1025S	\$66.00	200	\$0.00	1000
	SD Hex Coarse SS 10-16 x 35	SDS1035S	\$123.31	100	\$119.00	500
	SD Hex Coarse SS 12-14 x 20	SDS1220S	\$66.00	100	\$0.00	500
	SD Hex Coarse SS 12-14 x 45	SDS1245S	\$81.00	200	\$0.00	1000
	SD Hex Coarse SS 14-14 x 25	SDS1425S	\$142.97	200	\$128.88	1000
	SD Hex Coarse SS 14-14 x 50	SDS1450S	\$210.44	200	\$191.35	1000
SD Hex Coarse SS 14-14 x 75	SDS1475S	\$258.17	200	\$235.55	1000	

Hex Washer Face Head Self Drilling - Stainless Steel (With Neoprene)		Code	Trade Price		Bulk Price	
			\$/100	Qty Pkt	\$/100	Qty Pkt
	Product Details					
	SD Hex Coarse SS 10-16 x 16 Neo	SDSNEO1016S	\$ 132.80	200	\$128.00	1000
	SD Hex Coarse SS 12-14 x 20 Neo	SDSNEO1220S	\$ 151.76	100	\$146.00	500
	SD Hex Coarse SS 14-14 x 25 Neo	SDSNEO1425S	\$ 189.71	100	\$183.00	500
	SD Hex Coarse SS 14-14 x 50 Neo	SDSNEO1450S	\$ 270.33	200	\$261.00	1000
SD Hex Coarse SS 14-14 x 75 Neo	SDSNEO1475S	\$ 341.48	200	\$329.00	1000	

## Fasteners - Nuts And Bolts

Metric Hex Set Screw - Zinc Plated		Code	Trade Price		Bulk Price	
			\$/100	Qty Pkt	\$/100	Qty Pkt
	Product Details					
	4.6 Zn Plated Set Screw - M6 x 12mm	BOLTM06012	\$20.79	50	\$6.65	200
	4.6 Zn Plated Set Screw - M6 x 16mm	BOLTM06016	\$21.09	50	\$6.88	200
	4.6 Zn Plated Set Screw - M6 x 20mm	BOLTM06020	\$21.74	50	\$7.35	200
	4.6 Zn Plated Set Screw - M6 x 25mm	BOLTM06025	\$22.34	50	\$7.80	200
	4.6 Zn Plated Set Screw - M6 x 30mm	BOLTM06030	\$24.17	50	\$9.15	200
	4.6 Zn Plated Set Screw - M6 x 40mm	BOLTM06040	\$24.17	50	\$9.15	200
	4.6 Zn Plated Set Screw - M6 x 50mm	BOLTM06050	\$31.05	50	\$14.25	200
	4.6 Zn Plated Set Screw - M8 x 12mm	BOLTM08012	\$29.77	50	\$13.30	200
	4.6 Zn Plated Set Screw - M8 x 16mm	BOLTM08016	\$30.11	50	\$13.55	200
	4.6 Zn Plated Set Screw - M8 x 20mm	BOLTM08020	\$30.41	50	\$13.78	200
	4.6 Zn Plated Set Screw - M8 x 25mm	BOLTM08025	\$32.57	50	\$15.38	200
	4.6 Zn Plated Set Screw - M8 x 30mm	BOLTM08030	\$35.34	50	\$17.43	200
	4.6 Zn Plated Set Screw - M8 x 40mm	BOLTM08040	\$38.14	50	\$19.50	200
	4.6 Zn Plated Set Screw - M8 x 50mm	BOLTM08050	\$42.80	50	\$22.95	200
	4.6 Zn Plated Set Screw - M8 x 75mm	BOLTM08075	\$74.91	50	\$43.83	150
	4.6 Zn Plated Set Screw - M10 x 16mm	BOLTM10016	\$46.73	30	\$22.95	150
	4.6 Zn Plated Set Screw - M10 x 20mm	BOLTM10020	\$47.04	30	\$23.18	150
	4.6 Zn Plated Set Screw - M10 x 25mm	BOLTM10025	\$47.37	30	\$23.43	150
	4.6 Zn Plated Set Screw - M10 x 30mm	BOLTM10030	\$54.16	30	\$28.45	150
	4.6 Zn Plated Set Screw - M10 x 40mm	BOLTM10040	\$60.67	30	\$33.28	150
	4.6 Zn Plated Set Screw - M10 x 50mm	BOLTM10050	\$96.54	20	\$48.18	75
	4.6 Zn Plated Set Screw - M10 x 65mm	BOLTM10065	\$104.60	20	\$54.15	75
	4.6 Zn Plated Set Screw - M10 x 75mm	BOLTM10075	\$108.96	20	\$57.38	75
	4.6 Zn Plated Set Screw - M10 x 100mm	BOLTM10100	\$154.74	20	\$79.63	75
	4.6 Zn Plated Set Screw - M12 x 20mm	BOLTM12020	\$72.23	10	\$36.00	50
	4.6 Zn Plated Set Screw - M12 x 25mm	BOLTM12025	\$77.63	10	\$40.00	50
	4.6 Zn Plated Set Screw - M12 x 30mm	BOLTM12030	\$80.33	10	\$42.00	50
	4.6 Zn Plated Set Screw - M12 x 40mm	BOLTM12040	\$85.73	10	\$46.00	50
	4.6 Zn Plated Set Screw - M12 x 50mm	BOLTM12050	\$96.30	10	\$48.00	50
4.6 Zn Plated Set Screw - M12 x 75mm	BOLTM12075	\$126.00	10	\$70.00	50	
4.6 Zn Plated Set Screw - M12 x 100mm	BOLTM12100	\$193.79	10	\$108.55	50	
4.6 Zn Plated Set Screw - M16 x 40mm	BOLTM16040	\$182.01	10	\$99.83	50	
4.6 Zn Plated Set Screw - M16 x 45mm	BOLTM16045	POA	10	POA	50	
4.6 Zn Plated Set Screw - M16 x 50mm	BOLTM16050	\$236.86	10	\$140.45	50	
4.6 Zn Plated Set Screw - M16 x 65mm	BOLTM16065	\$246.44	10	\$147.55	50	
4.6 Zn Plated Set Screw - M16 x 75mm	BOLTM16075	\$338.58	10	\$180.80	50	
4.6 Zn Plated Set Screw - M16 x 130mm	BOLTM16130	\$806.09	10	\$527.10	50	
4.6 Zn Plated Set Screw - M20 x 40mm	BOLTM20040	\$355.66	10	\$193.45	50	
4.6 Zn Plated Set Screw - M20 x 50mm	BOLTM20050	\$377.06	10	\$209.30	50	

## Fasteners - Nuts And Bolts

Metric Hex Set Screw - Stainless Steel		Code	Trade Price		Bulk Price	
Product Details			\$/100	Qty Pkt	\$/100	Qty Pkt
	4.6 S/S Set Screw - M6 x 12mm	BOLTM0612S	\$30.51	50	\$10.75	200
	4.6 S/S Set Screw - M6 x 16mm	BOLTM0616S	\$32.18	50	\$12.30	200
	4.6 S/S Set Screw - M6 x 20mm	BOLTM0620S	\$34.02	50	\$14.00	200
	4.6 S/S Set Screw - M6 x 25mm	BOLTM0625S	\$36.18	50	\$16.00	200
	4.6 S/S Set Screw - M6 x 30mm	BOLTM0630S	\$36.69	50	\$16.48	200
	4.6 S/S Set Screw - M6 x 40mm	BOLTM0640S	\$42.66	50	\$22.00	200
	4.6 S/S Set Screw - M6 x 50mm	BOLTM0650S	\$71.28	50	\$31.00	200
	4.6 S/S Set Screw - M8 x 12mm	BOLTM0812S	\$43.74	50	\$23.00	200
	4.6 S/S Set Screw - M8 x 16mm	BOLTM0816S	\$44.71	50	\$23.90	200
	4.6 S/S Set Screw - M8 x 20mm	BOLTM0820S	\$48.06	50	\$27.00	200
	4.6 S/S Set Screw - M8 x 25mm	BOLTM0825S	\$51.14	50	\$29.85	200
	4.6 S/S Set Screw - M8 x 30mm	BOLTM0830S	\$55.73	50	\$34.10	200
	4.6 S/S Set Screw - M8 x 40mm	BOLTM0840S	\$64.26	50	\$42.00	200
	4.6 S/S Set Screw - M8 x 50mm	BOLTM0850S	\$70.74	50	\$48.00	200
	4.6 S/S Set Screw - M10 x 20mm	BOLTM1020S	\$69.55	30	\$46.90	150
	4.6 S/S Set Screw - M10 x 25mm	BOLTM1025S	\$78.46	30	\$55.15	150
	4.6 S/S Set Screw - M10 x 30mm	BOLTM1030S	\$82.57	30	\$58.95	150
	4.6 S/S Set Screw - M10 x 40mm	BOLTM1040S	\$96.66	30	\$72.00	150
	4.6 S/S Set Screw - M10 x 50mm	BOLTM1050S	\$103.30	20	\$78.15	75
	4.6 S/S Set Screw - M10 x 65mm	BOLTM1065S	\$142.18	20	\$96.65	75
	4.6 S/S Set Screw - M10 x 75mm	BOLTM1075S	\$145.80	20	\$100.00	75
	4.6 S/S Set Screw - M12 x 30mm	BOLTM1230S	\$118.26	10	\$92.00	50
	4.6 S/S Set Screw - M12 x 40mm	BOLTM1240S	\$154.49	10	\$108.05	50
	4.6 S/S Set Screw - M12 x 45mm	BOLTM1245S	\$156.60	10	\$110.00	50
	4.6 S/S Set Screw - M16 x 35mm	BOLTM16035S	\$276.48	10	\$186.00	50
	4.6 S/S Set Screw - M16 x 40mm	BOLTM16040S	\$295.92	10	\$204.00	50
	4.6 S/S Set Screw - M16 x 60mm	BOLTM16060S	\$352.08	10	\$256.00	50
	4.6 S/S Set Screw - M16 x 80mm	BOLTM16080S	\$414.05	10	\$313.38	50
4.6 S/S Set Screw - M16 x 180mm	BOLTM16180S	\$1,113.48	10	\$856.00	50	
4.6 S/S Set Screw - M20 x 40mm	BOLTM20040S	\$457.92	10	\$354.00	50	

Metric Hex Set Screw - Nylon		Code	Trade Price		Bulk Price	
Product Details			\$/100	Qty Pkt	\$/100	Qty Pkt
	M6x 25 Nylon Hex Set Screw	BOLTN06025	\$75.41		\$52.00	
	M8x 25 Nylon Hex Set Screw	BOLTN08025	\$150.82		\$105.00	
	M10 x 25 Nylon Hex Set Screw	BOLTN10025	\$248.91		\$161.00	
	M10 x 30 Nylon Hex Set Screw	BOLTN10030	\$263.98		\$174.00	
	M10 x 40 Nylon Hex Set Screw	BOLTN10040	\$283.20		\$192.00	
	M10 x 50 Nylon Hex Set Screw	BOLTN10050	\$288.31		\$197.00	

Ph: 02 9525 0970

Fax: 02 9540 2899

Email: orders@arrowsales.com.au

Please Note All Prices Are GST Exclusive





## Fasteners - Nuts And Bolts

Metric Hex Set Screw - Hot Dipped Galvanised		Code	Trade Price		Bulk Price	
			\$/100	Qty Pkt	\$/100	Qty Pkt
	<b>Product Details</b>					
	4.6 HDG B/N Kit - M6 x 25mm	BOLTG06025	\$26.21	50	\$11.48	200
	4.6 HDG B/N Kit - M6 x 50mm	BOLTG06050	\$30.78	50	\$15.00	200
	4.6 HDG B/N Kit - M8 x 25mm	BOLTG08025	\$40.47	50	\$22.48	200
	4.6 HDG B/N Kit - M8 x 40mm	BOLTG08040	\$46.14	50	\$26.85	200
	4.6 HDG B/N Kit - M8 x 50mm	BOLTG08050	\$57.89	50	\$33.00	200
	4.6 HDG B/N Kit - M10 x 20mm	BOLTG10020	\$53.27	30	\$34.00	150
	4.6 HDG B/N Kit - M10 x 25mm	BOLTG10025	\$54.43	30	\$35.00	150
	4.6 HDG B/N Kit - M10 x 30mm	BOLTG10030	\$57.93	30	\$38.00	150
	4.6 HDG B/N Kit - M10 x 35mm	BOLTG10035	\$62.60	30	\$42.00	150
	4.6 HDG B/N Kit - M10 x 40mm	BOLTG10040	\$67.26	30	\$46.00	150
	4.6 HDG B/N Kit - M10 x 45mm	BOLTG10045	\$71.93	30	\$50.00	150
	4.6 HDG B/N Kit - M10 x 50mm	BOLTG10050	\$90.20	20	\$54.00	75
	4.6 HDG B/N Kit - M10 x 60mm	BOLTG10060	\$97.20	20	\$60.00	75
	4.6 HDG B/N Kit - M10 x 65mm	BOLTG10065	\$104.20	20	\$66.00	75
	4.6 HDG B/N Kit - M10 x 75mm	BOLTG10075	\$111.20	20	\$72.00	75
	4.6 HDG B/N Kit - M10 x 80mm	BOLTG10080	\$120.53	20	\$80.00	75
	4.6 HDG B/N Kit - M10 x 90mm	BOLTG10090	\$138.80	20	\$84.00	75
	4.6 HDG B/N Kit - M10 x 100mm	BOLTG10100	\$141.13	20	\$86.00	75
	4.6 HDG B/N Kit - M10 x 110mm	BOLTG10110	\$151.63	20	\$95.00	75
	4.6 HDG B/N Kit - M10 x 120mm	BOLTG10120	\$161.25	20	\$103.25	75
	4.6 HDG B/N Kit - M12 x 25mm	BOLTG12025	\$81.65	10	\$56.00	50
	4.6 HDG B/N Kit - M12 x 30mm	BOLTG12030	\$84.24	10	\$58.00	50
	4.6 HDG B/N Kit - M12 x 35mm	BOLTG12035	\$91.69	10	\$62.00	50
	4.6 HDG B/N Kit - M12 x 40mm	BOLTG12040	\$94.28	10	\$64.00	50
	4.6 HDG B/N Kit - M12 x 50mm	BOLTG12050	\$116.21	10	\$78.00	50
	4.6 HDG B/N Kit - M12 x 60mm	BOLTG12060	\$123.98	10	\$84.00	50
	4.6 HDG B/N Kit - M12 x 80mm	BOLTG12080	\$167.22	10	\$111.53	50
	4.6 HDG B/N Kit - M12 x 100mm	BOLTG12100	\$183.38	10	\$124.00	50
	4.6 HDG B/N Kit - M16 x 50mm	BOLTG16050	\$209.30	10	\$144.00	50
	4.6 HDG B/N Kit - M16 x 65mm	BOLTG16065	\$232.42	10	\$156.00	50
	4.6 HDG B/N Kit - M16 x 70mm	BOLTG16070	\$242.78	10	\$164.00	50
	4.6 HDG B/N Kit - M16 x 80mm	BOLTG16080	\$255.74	10	\$174.00	50
	4.6 HDG B/N Kit - M16 x 90mm	BOLTG16090	\$281.66	10	\$194.00	50
	4.6 HDG B/N Kit - M16 x 110mm	BOLTG16110	\$338.26	10	\$226.00	50
4.6 HDG B/N Kit - M16 x 130mm	BOLTG16130	\$369.36	10	\$250.00	50	
4.6 HDG B/N Kit - M20 x 50mm	BOLTG20060	\$426.06	10	\$293.75	50	
4.6 HDG B/N Kit - M20 x 60mm	BOLTG20060	\$426.06	10	\$293.75	50	
4.6 HDG B/N Kit - M20 x 70mm	BOLTG20070	\$452.50	10	\$314.15	50	
4.6 HDG B/N Kit - M20 x 80mm	BOLTG20080	\$498.31	10	\$349.50	50	
4.6 HDG B/N Kit - M20 x 90mm	BOLTG20090	\$575.21	10	\$385.50	50	
4.6 HDG B/N Kit - M20 x 100mm	BOLTG20100	\$609.75	10	\$412.15	50	
4.6 HDG B/N Kit - M20 x 110mm	BOLTG20110	\$691.78	10	\$475.45	50	
4.6 HDG B/N Kit - M20 x 120mm	BOLTG20120	\$725.41	10	\$501.40	50	
4.6 HDG B/N Kit - M20 x 130mm	BOLTG20130	\$803.92	10	\$561.98	50	
4.6 HDG B/N Kit - M20 x 140mm	BOLTG20140	\$842.21	10	\$579.85	50	
4.6 HDG B/N Kit - M20 x 150mm	BOLTG20150	\$852.06	10	\$587.45	50	
4.6 HDG B/N Kit - M20 x 160mm	BOLTG20160	\$885.07	10	\$612.93	50	
4.6 HDG B/N Kit - M20 x 170mm	BOLTG20170	\$894.56	10	\$620.25	50	



## Fasteners - Nuts And Bolts

Imperial Hex Set Screw - Stainless Steel		Code	Trade Price		Bulk Price	
			\$/each	Qty Pkt	\$/each	Qty Pkt
	Product Details					
	304 SET SCRW: 1/4UNC X 1-1/2	BOLT14I112S	\$0.67		\$0.24	
	304 SET SCRW: 1/4UNC X 1-1/4	BOLT14I114S	\$0.64		\$0.22	
	304 SET SCRW: 1/4UNC X 1	BOLT14I1S	\$0.61		\$0.20	
	304 SET SCRW: 1/4UNC X 3/4	BOLT14I34S	\$0.56		\$0.17	
	316 S/Steel Hex Set Screw 1/4 x 3/4	BOLT14I34S16	\$0.26		\$0.00	

Cup Head Set and Nut - Hot Dipped Galvanised		Code	Trade Price		Bulk Price	
			\$/each	Qty Pkt	\$/each	Qty Pkt
	Product Details					
	4.6 Cup Head B/N Kit - M6 x 20mm	CUPMG06020	\$0.32	50	\$0.13	200
	4.6 Cup Head B/N Kit - M6 x 25mm	CUPMG06025	\$0.32	50	\$0.13	200
	4.6 Cup Head B/N Kit - M8 x 20mm	CUPMG08020	\$0.44	50	\$0.21	200
	4.6 Cup Head B/N Kit - M8 x 25mm	CUPMG08025	\$0.50	50	\$0.25	200
	4.6 Cup Head B/N Kit - M8 x 30mm	CUPMG08030	\$0.58	50	\$0.31	200
	4.6 Cup Head B/N Kit - M8 x 75mm	CUPMG08075	\$0.96	50	\$0.48	200
	4.6 Cup Head B/N Kit - M10 x 25mm	CUPMG10025	\$0.73	50	\$0.41	200
	4.6 Cup Head B/N Kit - M10 x 30mm	CUPMG10030	\$0.73	50	\$0.41	200
	4.6 Cup Head B/N Kit - M10 x 90mm	CUPMG10090	\$1.70	25	\$0.82	25
	4.6 Cup Head B/N Kit - M10 x 100mm	CUPMG100100	\$1.74	25	\$0.84	25
	4.6 Cup Head B/N Kit - M10 x 110mm	CUPMG100110	\$1.78	25	\$0.87	25
4.6 Cup Head B/N Kit - M10 x 170mm	CUPMG10170	\$2.19	25	\$1.33	25	

Cup Head Set and Nut - Zinc Plated		Code	Trade Price		Bulk Price	
			\$/each	Qty Pkt	\$/each	Qty Pkt
	Product Details					
	4.6 Cup Head B/N Kit - M6 x 20mm	CUPZ0620	\$0.28	50	\$0.10	200
	4.6 Cup Head B/N Kit - M6 x 25mm	CUPZ0625	\$0.28	50	\$0.11	200
	4.6 Cup Head B/N Kit - M6 x 30mm	CUPZ0630	\$0.29	50	\$0.11	200
	4.6 Cup Head B/N Kit - M6 x 40mm	CUPZ0640	\$0.36	50	\$0.16	200
	4.6 Cup Head B/N Kit - M6 x 50mm	CUPZ0650	\$0.38	50	\$0.17	200
	4.6 Cup Head B/N Kit - M6 x 65mm	CUPZ0665	\$0.46	25	\$0.20	150
	4.6 Cup Head B/N Kit - M6 x 75mm	CUPZ0675	\$0.47	25	\$0.21	150
	4.6 Cup Head B/N Kit - M8 x 25mm	CUPZ08025	\$0.12	25	\$0.00	150
	4.6 Cup Head B/N Kit - M10 x 20mm	CUPZ1020	\$0.60	25	\$0.33	150
	4.6 Cup Head B/N Kit - M10 x 25mm	CUPZ1025	\$0.62	25	\$0.34	150
	4.6 Cup Head B/N Kit - M10 x 30mm	CUPZ1030	\$0.66	25	\$0.36	150
4.6 Cup Head B/N Kit - M10 x 50mm	CUPZ1050	\$0.92	25	\$0.46	150	

## Fasteners - Nuts And Bolts

Metric Nuts With Nylon Insert - Zinc Plated		Code	Trade Price		Bulk Price		
Product Details			\$/100	Qty Pkt	\$/100	Qty Pkt	
		M10 Nylon Insert	NUTNM10	\$28.38	50	\$17.53	200
		M12 Nylon Insert	NUTNM12	\$47.79	25	\$26.75	100

Metric Nuts With Nylon Insert - Stainless Steel		Code	Trade Price		Bulk Price		
Product Details			\$/100	Qty Pkt	\$/100	Qty Pkt	
		M10 Nylon Insert	NUTNM10S	\$58.73	50	\$36.88	200
		M12 Nylon Insert	NUTNM12S	\$78.57	25	\$55.25	100

Washers - Zinc Plated		Code	Trade Price		Bulk Price		
Product Details			\$/100	Qty Pkt	\$/100	Qty Pkt	
		M6 Zn Plated M/S Round Washer	WASHER06	\$5.94	200	\$2.00	500
		M8 Zn Plated M/S Round Washer	WASHER08	\$7.72	200	\$3.65	500
		M10 Zn Plated M/S Round Washer	WASHER10	\$10.64	200	\$6.35	500
		M12 Zn Plated M/S Round Washer	WASHER12	\$19.12	500	\$8.95	100
		M16 Zn Plated M/S Round Washer	WASHER16	\$27.49	50	\$16.70	50
		M20 Zn Plated M/S Round Washer	WASHER20	\$34.15	100	\$19.95	200
		M10 x 30 Zn Plated Large Washer	WASHER10LG	\$18.52	50	\$13.65	50
		M10 x 40 Zn Plated Large Mud Washer	WASHER10LMG	\$26.49	100	\$15.78	200
		M12 x 30 Zn Plated Large Washer	WASHER12LG	\$35.10	50	\$23.75	150

Washers - Hot Dipped Galvanised		Code	Trade Price		Bulk Price		
Product Details			\$/100	Qty Pkt	\$/100	Qty Pkt	
		M6 HDG M/S Round Washer	WASHER06G	\$6.86	200	\$2.85	500
		M8 HDG M/S Round Washer	WASHER08G	\$8.45	200	\$4.33	500
		M10 HDG M/S Round Washer	WASHER10G	\$11.88	200	\$7.50	500
		M12 HDG M/S Round Washer	WASHER12G	\$22.36	50	\$11.95	200
		M16 HDG M/S Round Washer	WASHER16G	\$35.21	50	\$23.85	200
		M20 HDG M/S Round Washer	WASHER20G	\$51.26	50	\$35.80	150

Spring Washers - Zinc Plated		Code	Trade Price		Bulk Price		
Product Details			\$/100	Qty Pkt	\$/100	Qty Pkt	
		M10 ZYP Spring Washer	WASHER10SP	\$13.18	50	\$3.45	200
		M12 ZYP Spring Washer	WASHER12SP	\$16.88	100	\$6.88	200
		M16 ZYP Spring Washer	WASHER16SP	\$22.82	50	\$12.38	200

Rod Couplers - Zinc Plated		Code	Trade Price		Bulk Price		
Product Details			\$/each	Qty Pkt	\$/each	Qty Pkt	
		M10 x 40 ZYP M/S Hex Coupler	HEXCZ10	\$0.84	25	\$0.53	100
		M12 x 40 ZYP M/S Hex Coupler	HEXCZ12	\$1.17	10	\$0.81	100
		M16 x 50 ZYP M/S Hex Coupler	HEXCZ16	\$2.31	10	\$1.59	50

Ph: 02 9525 0970

Fax: 02 9540 2899

Email: orders@arrowsales.com.au

Please Note All Prices Are GST Exclusive

## Fasteners - Nuts and Bolts

Metric Hex Nut - Zinc Plated		Code	Trade Price		Bulk Price	
Product Details			\$/100	Qty Pkt	\$/100	Qty Pkt
	M6 Hex Nut	NUT06	\$4.37	200	\$2.30	1000
	M8 Hex Nut	NUT08	\$8.59	150	\$4.45	500
	M10 Hex Nut	NUT10	\$18.31	100	\$8.20	200
	M12 Hex Nut	NUT12	\$23.36	50	\$12.88	200
	M16 Hex Nut	NUT16	\$42.28	50	\$30.40	200
	M20 Hex Nut	NUT20	\$98.44	25	\$73.65	100

Metric Hex Nut - Stainless Steel		Code	Trade Price		Bulk Price	
Product Details			\$/each	Qty Pkt	\$/each	Qty Pkt
	M6 Hex Nut	NUT06S	\$0.28	200	\$0.08	1000
	M8 Hex Nut	NUT08S	\$0.32	150	\$0.12	500
	M10 Hex Nut	NUT10S	\$0.47	100	\$0.26	200
	M12 Hex Nut	NUT12S	\$0.58	50	\$0.36	200
	M16 Hex Nut	NUT16S	\$1.13	50	\$0.70	200
	M20 Hex Nut	NUT20S	\$3.30	25	\$2.36	100

Washer - Stainless Steel		Code	Trade Price		Bulk Price	
Product Details			\$/100	Qty Pkt	\$/100	Qty Pkt
	M6 S/S Plated M/S Round Washer	WASHER06S	\$21.90	150	\$2.78	500
	M8 S/S Plated M/S Round Washer	WASHER08S	\$23.65	150	\$4.40	500
	M10 S/S Plated M/S Round Washer	WASHER10S	\$24.89	150	\$5.55	500
	M12 S/S Plated M/S Round Washer	WASHER12S	\$28.62	25	\$9.00	100
	M16 S/S Plated M/S Round Washer	WASHER16S	\$34.16	25	\$14.13	100
	M20 S/S Plated M/S Round Washer	WASHER20S	POA	25	POA	100

Metric Threaded Rod - Hot Dipped Galvanised (1M Lengths)		Code	Trade Price		Bulk Price	
Metric	\$/100		Qty Pkt	\$/100	Qty Pkt	
	M8	ROD08G1	\$4.55	5	\$3.34	20
	M10	ROD10G1	\$5.76	3	\$4.46	10
	M12	ROD12G1	\$8.63	3	\$6.24	10
	M16	ROD16G1	\$13.92	3	\$11.14	10
	M20	ROD20G1	\$22.84	2	\$17.65	5
	M24	ROD24G1	\$35.06	2	\$28.96	5

Metric Threaded Rod - Hot Dipped Galvanised (3M Lengths)		Code	Trade Price		Bulk Price	
Metric	\$/100		Qty Pkt	\$/100	Qty Pkt	
	M8	ROD08G	\$11.26	3	\$8.68	10
	M10	ROD10G	\$16.35	3	\$13.39	10
	M12	ROD12G	\$24.18	2	\$18.89	5
	M16	ROD16G	\$44.59	2	\$37.79	5
	M20	ROD20G	\$80.11	1	\$56.68	2
	M24	ROD24G	\$107.93	1	\$82.43	2
M30	ROD30G	\$158.45	1	\$129.22	2	

Ph: 02 9525 0970

Fax: 02 9540 2899

Email: orders@arrowsales.com.au

## Fasteners - Nuts and Bolts

Metric Threaded Rod - Stainless Steel (1M Lengths)		Code	Trade Price		Bulk Price	
Metric	\$/100		Qty Pkt	\$/100	Qty Pkt	
	M6	ROD06S	\$5.99	3	\$3.80	10
	M8	ROD08S	\$9.88	3	\$7.40	10
	M10	ROD10S	\$13.12	3	\$10.40	10
	M12	ROD12S	\$23.22	2	\$18.00	5
	M16	ROD16S	\$34.02	2	\$28.00	5
	M20	ROD20S	\$53.46	1	\$46.00	2
	M24	ROD24S	\$70.74	1	\$62.00	2

Metric Threaded Rod - Stainless Steel (3M Lengths)		Code	Trade Price		Bulk Price	
Metric	\$/100		Qty Pkt	\$/100	Qty Pkt	
	M6	ROD06S3	\$17.04	3	\$14.90	10
	M8	ROD08S3	\$27.81	3	\$24.00	10
	M10	ROD10S3	\$41.76	2	\$36.92	5
	M12	ROD12S3	\$78.62	2	\$55.30	5
	M16	ROD16S3	\$127.98	1	\$101.00	2
	M20	ROD20S3	\$192.78	1	\$161.00	2
	M24	ROD24S3	\$256.50	1	\$220.00	2

Metric Threaded Rod - 316 Stainless Steel (1M Lengths)		Code	Trade Price		Bulk Price	
Metric	\$/100		Qty Pkt	\$/100	Qty Pkt	
	M6	ROD31606S	\$7.72	5	\$5.40	20
	M8	ROD31608S	\$12.69	3	\$10.00	10
	M10	ROD31610S	\$17.01	3	\$14.00	10
	M12	ROD31612S	\$27.54	2	\$22.00	5

Metric Threaded Rod - 316 Stainless Steel (3M Lengths)		Code	Trade Price		Bulk Price	
Metric	\$/100		Qty Pkt	\$/100	Qty Pkt	
	M6	ROD31606S3	\$23.49	3	\$20.00	10
	M8	ROD31608S3	\$37.57	3	\$33.04	10
	M10	ROD31610S3	\$58.48	2	\$52.40	5
	M12	ROD31612S3	\$97.31	1	\$72.60	2

Metric Threaded Rod - Zinc Plated (3M Lengths)		Code	Trade Price		Bulk Price	
Metric	\$/100		Qty Pkt	\$/100	Qty Pkt	
	M6	ROD06	\$6.05	3	\$4.72	10
	M8	ROD08	\$10.31	3	\$7.80	10
	M10	ROD10	\$8.89	2	\$6.33	5
	M12	ROD12	\$14.58	2	\$10.00	5
	M16	ROD16	\$39.87	1	\$33.42	2
	M20	ROD20	\$62.38	1	\$49.01	2
	M24	ROD24	\$98.30	1	\$73.52	2
	M30	ROD30	\$139.64	1	\$111.80	2

Ph: 02 9525 0970

Fax: 02 9540 2899

Email: [orders@arrowsales.com.au](mailto:orders@arrowsales.com.au)

## Application for Commercial Credit

### *Including Personal Guarantee & Indemnity Agreement*

WARNING: If you do not understand this document, you should seek independent legal advice. Please do not use correction fluid or tape as this is a legal document. Any corrections should be crossed out and initialled.

#### Applicant Details (Enter all relevant details pertaining to your business)

Registered Name					
A.C.N		A.B.N			
Credit Limit Requested					
Company		Sole Trader		Partnership	Other
Nature of Business			Date of Company Registration		
Street Address (Not a PO Box)					
State			Postcode		
Postal Address (if Different)					
State			Postcode		
Telephone Number			Fax Number		
Mobile Number			Email Address		

#### Partner, Sole Trader or Director Details (All Applicants MUST Complete)

Names of Directors (If Company), Partnership or Sole Trader	Residential Address	Owning or Renting	Date of Birth dd/mm/yyyy	Driver's Licence No.

#### Contact Details

Primary Contact	Primary Contact:	Ph:	Email:
Primary Contact	Primary Contact:	Ph:	Email:



**Bank Details**

ABN: 47 102 419 152

<b>Bank</b>		<b>Account Name</b>	
<b>Branch</b>		<b>BSB:</b>	<b>Account No.:</b>

**Trade References (Major Suppliers)**

Name	Email	Phone	Fax

Has the Applicant of any associated company or person traded with US now or in the past Yes  No

**Terms of the Commercial Credit Application and the PPSA**

By signing this Commercial Credit Application, YOU hereby acknowledge and agree that YOU are applying for a Commercial Credit Account with Arrow Sales Pty Ltd on the conditions that YOU together with the Arrow Sales will constitute a Commercial Credit Agreement between us for the purposes of the Personal Property Securities Act 2009 ("PPSA") and all purchases of goods or services by YOU the customer from Arrow Sales the Supplier will be subject to the following terms and conditions of sale which are incorporated into any contract for the provision of goods and/or services by the Supplier (Arrow Sales) to the Customer (YOU): -

Until YOU as the customer have paid in full for any service or goods provided by the Arrow Sales the Supplier, no interest or title in any goods shall pass to YOU as the Customer, although risk in the goods passes to YOU the Customer upon delivery. If the goods are delivered to YOU the Customer before payment has been made and title given, YOU the Customer shall have possession of the goods as bailee only. As bailee thereof, YOU the Customer will not dispose of, sell, or grant any security over the goods. YOU the Customer will be responsible for any damage to or loss of the goods. Arrow Sales the Supplier may terminate such bailment at any time by giving written notice to YOU the Customer

If possession of the goods is transferred to YOU the Customer and Arrow Sales the Supplier has not received full payment for the goods, then upon YOU the Customer taking possession of the goods, YOU the Customer grants to Arrow Sales the Supplier a purchase money security interest ('PMSI') pursuant to the PPSA in the goods; and any proceeds of those goods

Arrow Sales the Supplier shall have the right to register a financing statement for that PMSI pursuant to the PPSA and YOU the Customer agrees to execute any documents and do all other things required by Arrow Sales the Supplier to ensure that Arrow Sales the Supplier maintains a perfected security interest as that term is defined in the PPSA. YOU the Customer agree that such PMSI will have priority over all other security interests in the goods

YOU the Customer agrees to pay all costs incurred by the Supplier relating to the registration and/or variation or removal of its security interest; and any enforcement thereof

YOU the Customer agree that ss 142- 143 of the PPSA will not apply to this Agreement or the security interest granted to Arrow Sales the Supplier by YOU the Customer. YOU the Customer hereby waives its rights to receive a:

- Notice of removal of an accession under S95 PPSA
- Notice of an intention to seize collateral under S123 PPSA
- Notice of disposal of collateral under S130 PPSA
- Statement of account under S132(3)(d) PPSA
- Statement of account if there is no disposal under S132(4) PPSA
- Notice of retention of collateral under S135 PPSA
- Notice of verification statement under S157 PPSA

Time for payment shall be of the essence. Events of default by YOU the Customer for the purpose of ss23 of the PPSA shall include failure to pay any monies due, the insolvency of YOU the Customer, or a failure by YOU the Customer to comply with any of its other obligations under this Commercial Credit Application. In the event of any such default, all monies payable, whether or not due for payment, shall become immediately payable by YOU the Customer

Warrant that all information provided by YOU the Customer to Arrow Sales the Supplier in relation to this Commercial Credit Application is true and complete and acknowledge that Arrow Sales the Supplier rely on the information in making a decision to grant a Credit Account

By signing this Application for Credit, YOU the customer consent and authorise Arrow Sales the supplier: -

- To obtain any information about YOU the customer or commercial credit or business history or YOUR commercial activities or commercial credit worthiness from external credit reporting agencies and or any trade references disclosed in this Application for Credit and any other credit provider for the purpose of assessing the application for credit, or in connection with any guarantee and to disclose such information to a credit reporting agency
- To give a person who is currently guarantor, or whom YOU the Customer have indicated is considering becoming a guarantor, a credit report containing information about YOU the Customer for the purpose of the Guarantor deciding whether to act as guarantor, or to keep the Guarantor informed about the guarantee. You understand we may disclose any information about YOUR credit worthiness, credit standing, credit history or credit capacity that credit providers are allowed to disclose under the Privacy Act
- Unless otherwise prevented by law to collect from, store, use, disclose to or exchange with any parties named above or any Guarantors or other credit providers named in this Application for Credit or named in a consumer credit report issued by a credit reporting agency, third party providers, solicitors, mercantile agents, insolvency administrators, insurers and insurance brokers, persons involved with the collection of trade bills or the factoring of trade debt, information about YOUR personal or commercial credit worthiness or business history in order to assess the Application for Commercial Credit (including whether to accept as Guarantor any person signing), monitor the credit worthiness or withdraw credit facilities, notify your default, issue trade bills, insure risk, process any payment instructions, direct debit facilities and or credit facilities requested by YOU the customer and or Guarantor(s) to enable the daily operation of YOUR Commercial Credit Account and collect overdue monies
- To the extent permitted by law, to disclose the contents of a credit report by a reporting agency to OUR solicitors or mercantile agents
- Unless otherwise prevented by law, YOU the customer consent to the use of any personal information provided for the following purposes and any other purposes as shall be agreed between US Arrow Sales and YOU the Customer from time to time



YOU the customer agree to advise Arrow Sales the Supplier in writing of the occurrence of any Insolvency Event, any change in its name, ownership or control, or any step being taken to sell an asset or assets (separately or together having a value being greater than 20% in value of its gross assets) as soon as practicable and not later than within two (2) business days of such event, change or step occurring. YOU the Customer acknowledges that, despite any such event, change or step YOU the Customer remains liable to pay the price for all Goods Supplied by Arrow Sales the Supplier

YOU the customer agree to pay without any deduction or setoff the price charged by Arrow Sales the Supplier for goods supplied to YOU the Customer on receipt or delivery, if credit terms are offered, within thirty (30) Days following the end of the month during which the goods were supplied or provided

Any amount not paid by the due will incur interest at a rate of 12% per annum calculated daily and compounded monthly

Payments made by Visa, MasterCard or American Express will attract a 2% surcharge

Deductions from payments for any reason will not be allowed unless Arrow Sales has issued a tax adjustment note. All tax adjustments are issued by Arrow Sales the Supplier to YOU the Customer and are not transferable

YOU the Customer agree to pay all costs and expenses (including legal costs, commissions paid by Arrow Sales the Supplier to any commercial or mercantile agent and dishonour fees) incurred by Arrow Sales the Supplier in connection with the recovery of overdue amounts and enforcing the charge in clause 10(c)

As security for any amounts due to the Arrow Sales the Supplier from time to time, YOU the Customer charges all of its legal and equitable interest (both present and future) of whatsoever nature held in any and all Real Property to Arrow Sales the Supplier

Arrow Sales the Supplier reserves the right to require YOU the Customer to spend a minimum dollar amount per year to obtain products or services on a credit account (charged to YOUR account)

Arrow Sales may, in its sole discretion and without requiring any reason to do so, at any time, suspend or terminate YOUR commercial trading account without notice

Arrow Sales specifies the maximum (GST Inclusive) Credit Limit amount that may be charged to the Account over a particular period (Credit Limit). YOUR Credit Limit is subject to review at any time by Arrow Sales the Supplier. Arrow Sales the Supplier may, on request in writing by YOU the Customer, agree in writing to increase or decrease the Credit Limit. The balance of the Account at any time must not exceed the Credit Limit. Arrow Sales is not responsible for any loss or damages whatsoever caused arising from refusal by Arrow Sales to supply the YOU the Customer with any products on credit because the Credit Limit has been exceeded. YOU the Customer agrees to immediately pay the amounts charged to YOUR account for any products supplied by Arrow Sales in excess of the Credit Limit, whether or not demand for payment has been made by Arrow Sales

YOU the Customer are responsible for and indemnify Arrow Sales against any unauthorised use of YOUR account

All orders are subject to acceptance by Arrow Sales the Supplier and hereafter referred to as Arrow Sales due to the high cost of processing orders, a minimum order of \$200.00 is required

Prices are subject to change without notice. Please be aware that orders will be invoiced at the pricing prevailing at the time of the order. Prices are not guaranteed

No deductions are allowed for freight on back orders. Arrow Sales will endeavour to ship the bulk of your order at one time and back ordered products will be shipped as soon as possible thereafter. All back orders are cancelled after three (3) months unless otherwise instructed by YOU the Customer. Part shipments may be made and orders will be considered complete if Arrow Sales the Supplier is unable to deliver the entire order. In such event, YOU the Customer waives its right to claim a reduction in price or cancellation of sale

Freight charges will be applicable to all orders and are subject to change without notice. Any increases in freight and fuel levies that are applied to Arrow Sales the Supplier by our freighting sub-contractors will automatically be applied to YOU the customer

Arrow Sales the Supplier is not liable or responsible for loss or damage in transit. Deliveries should be carefully checked upon delivery for total carton count and condition. Any shortage or evidence of damage must be noted on the freight carrier's delivery receipt and reported immediately to Arrow Sales. Any short deliveries in unopened cartons that be attributed to picking/packing errors must be reported to Arrow Sales within two (2) working days of receipt of goods

Any items that YOU the Customer consider to be defective must be pre-authorised by Arrow Sales the Supplier. All such returns require a return authorisation and must be shipped back to Arrow Sales immediate. Authorised returns of products considered to be defective will be subject to inspection by Arrow Sales. It must also be noted that Arrow Sales reverse the right to refuse credit or replacement should we feel that the product has been mistreated or damaged intentionally

All returns must be authorised in advance by Arrow Sales. All credit claims must be made within two (2) working days of the invoice date. Authorised returns will be assessed at a 15% restocking charge and must be shipped to Arrow Sales prepaid by YOU the Customer. There may be additional fees incurred if the product is deemed to have been received in an unsaleable condition (for example un-bagged, product price tagged, other markings on product, etc)

#### **Acknowledgment**

YOU the Customer acknowledge that the Goods it will acquire from Arrow Sales Pty Ltd will be obtained for either the purpose of re-supply (whether or not in an altered form or as part of some other manufacture) or for the purpose of using them up or transforming them in trade or commerce in the course of a process of production or manufacture or in the course of repairing or treating other goods or fixtures.

#### **Who MUST sign this Application for Commercial Credit: -**

For Companies – Where there is only one (1) director for the company then that person must sign; where there are two (2) or more directors for the company then all Directors MUST sign.

Sole Traders operating under their own name or under a business name.

Partnerships – All Partners of the Partnership.

**You the Customer agrees to be bound by the Application for Commercial Credit Account and Conditions as stated above of this Agreement**

**Signatory**

**Witness (Executed by Independent Witnesses)**

<b>Print Name (in block letters)</b>		<b>Print Name (in block letters)</b>	
<b>Position</b>		<b>Position</b>	
<b>Signature</b>		<b>Signature</b>	
<b>Date</b>	____ / ____ / 20____	<b>Date</b>	____ / ____ / 20____

		<b>Print Name (in block letters)</b>	
<b>Position</b>		<b>Position</b>	
<b>Signature</b>		<b>Signature</b>	
<b>Date</b>	____ / ____ / 20____	<b>Date</b>	____ / ____ / 20____

**Personal Guarantee & Indemnity Agreement**

As part of your application for Commercial Credit, this Personal Guarantee and Indemnity Agreement must be completed and signed by all Directors, Sole Traders and Business Partners in the presence of an Independent Witness (not Spouses/Partners or Family Members). Spouses/Partners of all Directors, Sole Traders and Business Partners must sign as Guarantors in the presence of Independent witnesses where there is joint ownership of personal assets.

I/We, the  
Guarantor(s), \_\_\_\_\_  
\*\*\*Insert Guarantor(s) name as applicable\*\*\*

Have requested Arrow Sales the Supplier to  
supply \_\_\_\_\_  
\*\*\*Insert Company Name/Partnership/Sole  
Trader\*\*\*

Trading as (if  
applicable) \_\_\_\_\_  
\*\*\*Insert Registered Business Name\*\*\*

(YOU the Customer) of  
\_\_\_\_\_  
\*Insert Street Address (Not a PO Box) \*

\_\_\_\_\_  
\*State\* \*Postcode\*

## With Goods & Services on Credit

**NB: Guarantor(s) names need to agree with those on Certificate of Guarantee – Executed as a Deed Below**

The Guarantors hereby **jointly and severally agree** with Arrow Sales as follows: -

I/We guarantee payment to the Arrow Sales the Supplier of the whole price charged Arrow Sales the Supplier for Goods or Services supplied to US the Customer from time to time, without any deduction or setoff what-so-ever. I/We also guarantee payment of any other monies now or in the future owing by US the Customer to Arrow Sales the Supplier. I/We also guarantee the performance of the obligations of US the Customer pursuant to the guarantee given by the US the Customer to Arrow Sales the Supplier in the Commercial Credit Account Terms and Conditions I/We indemnify Arrow Sales the Supplier against all costs, losses and expenses which Arrow Sales the Supplier incur as a result of any default by US the Customer.

My/Our guarantee and indemnity under this Guarantee is a continuing guarantee and will not be affected: -

If Arrow Sales the Supplier grants any extension of time or other indulgence to US the Customer or varies the terms of account (even if this increases my/our liability under this Guarantee)

By the release of any of the Guarantors or if this Guarantee is or becomes unenforceable against one or more of the Guarantors

Any Payment by US the Customer being later avoided by law, whether or not I/We have been given notice of the matters

I/We agree that an application for commercial credit made by the Customer is deemed to have been accepted from the date of the first invoice by the Arrow Sales the Supplier to US the Customer and without further notice to me/us, this Guarantee will extend to all liabilities from the Customer to Arrow Sales the Supplier

This Guarantee extends to credit given to the Customer in the future by a company which is not now, but at the time such credit is extended

This Guarantee may be withdrawn by the Guarantor(s) on expiry of 30 Days following written notice of withdrawal being delivered to Arrow Sales the Supplier. This Guarantee will continue in force in respect of all debt incurred up to the date of withdrawal

I/We authorise Arrow Sales to do each of the things listed in Application for Commercial Credit Account Terms and Conditions in relation to my/our personal credit matters

As security for the obligations and liabilities of the Guarantor(s), I/We charge the due and punctual payment and performance of those obligations and liabilities, all of my/our legal and equitable interest (including as beneficial owner, both present and future) of whatsoever nature held in any and all Real Property in favour of Arrow Sales the Supplier

Without limiting the generality of the charge above, I/We agree on request by Arrow Sales the Supplier to execute any documents and do all things reasonably required by Arrow Sales the Supplier to register a mortgage security over any Real Property. In the event that the Guarantor(s) fails to deliver the requested documents, the Guarantor(s) hereby appoints Arrow Sales to be the Guarantor's(s) lawful attorney for the purposes of executing and registering such documents. I/We indemnify Arrow Sales the Supplier on an indemnity basis against all costs and expenses incurred by Arrow Sales the Supplier as the case may be in connection with the preparation and registration of such mortgage documents

I/We consent unconditionally to Arrow Sales the Supplier both lodging a caveat or caveats noting its interest in any Real Property

We agree to advise Arrow Sales the Supplier in writing of the occurrence of any Insolvency Event and change in my/our name, ownership or control, or any step being taken to sell an asset or assets (separately or together having a value being greater than 20% in value of my/our gross assets) as soon as practicable and not later than within two (2) business days of such event, change or step occurring

If any payment made by or on behalf of the US the Customer is alleged to be void or voidable by any liquidator or like officer of the Customer under any law related to insolvency, I/We indemnify Arrow Sales the Supplier against any costs or losses it may incur in connection with such claim. This indemnity shall continue to apply notwithstanding any withdrawal as above

If a charge created above is or becomes void or unenforceable, it may be severed from this Guarantee without effect on Arrow Sales' right against the Guarantor(s)

Any condition or agreement under this Guarantee by or in favour of two (2) or more persons is deemed to bind them jointly and severally, or be in favour of each of them severally. If the Guarantor comprises more than one person Arrow Sales the Supplier may at any time and from time to time, proceed against any or all of them in respect of the Guarantor's obligations as the Arrow Sales the Supplier is not obliged to make any claim against all the persons comprising the Guarantor

Until the whole of the YOUR obligations as the Customer have been paid or satisfied in full, the Guarantor must not (except with the prior written consent of the Arrow Sales the Supplier) either directly or indirectly and either before or after the winding up or bankruptcy of the Customer, or any person, take any steps to recover or enforce a right or claim against YOU the Customer relating to any sum paid by the Guarantor to Arrow Sales the Supplier under this guarantee including without limitation proving or claiming in competition with Arrow Sales the Supplier so as to diminish any distribution, dividend or payment which, but for the proof of claim, Arrow Sales the Supplier would be entitled to receive pursuant to the winding up or bankruptcy of YOU the customer

The definitions in the Application for Commercial Credit Account Terms and Conditions shall apply in this Guarantee, except that "Real Property" shall mean all real property owned by the Guarantor(s) now or in the future, solely or jointly. Also, singular words include the plural and vice versa and references to any party to this Guarantee, include that party's executors, administrators, substitutes, successors or permitted assigns

### **Certificate of Guarantee – Executed as a Deed**

*By signing below as Guarantor(s), I/We understand the terms of this Guarantee. In particular, I/We understand that if the Customer fails to make any required payments to Arrow Sales the Supplier, Arrow Sales may recover the amount of these payments from me/us personally. In such case, Arrow Sales the Supplier may, amongst other recovery rights, take a charge over any Real Property.*

*I/We certify that I/We have had the opportunity of taking independent legal advice in relation to the meaning and effect of this Guarantee. All Directors, Sole Traders, Business Partners and any other Guarantors complete, print and sign below as Guarantors in the presence of Independent Witnesses (not Spouses or Family Members)*

Spouses of all Directors, Sole Traders and Business Partners must also sign below as Guarantors in the presence of Independent Witnesses.

Guarantor		Witness (Executed by Independent Witnesses)	
Print Name (in block letters)		Print Name (in block letters)	
Address		Address	
Signature		Signature	
Date	/ /20	Date	/ /20

Print Name (in block letters)		Print Name (in block letters)	
Address		Address	
Position		Position	
Signature		Signature	
Date	/ /20	Date	/ /20

**Mailing Instructions**

*For your application to be processed ensure you have completed and signed both the Application for Commercial Credit Form and the Personal Guarantee and Indemnity Agreement. Please return all original and witnessed documents to Arrow Sales Pty Ltd.*

Arrow Sales Pty Ltd  
 Attention: Accounts Department  
 PO Box 2998, Taren Point NSW 2229

## Conditions of Sale

All special orders are to be in the form of written confirmation. Cancellation or return of special orders will not be accepted.

The customer will be deemed to have accepted the goods as being in accordance with its order unless a written notification is received within 7 days of receipt of goods.

Returns for credit will be subjected to a 15% surcharge. All goods must be in original condition.

Minimum invoice of \$40 otherwise an Administration Fee of \$5.00 is applicable.

Prices are subject to change without notice.

Trading Terms are strictly Nett 30 Days.

All care was taken in preparing the information in this catalogue and is believed correct. It is subject to alternation without notice. No responsibility is taken for errors or omissions.

All warranties whether express or implied and whether statutory or otherwise with regard to the goods supplied by the company as to quality, fitness for purpose or any other matter are hereby excluded except insofar as any such warranties are incapable of exclusion at law.

Goods shall be delivered to the address as specified on the credit application unless otherwise agreed upon in writing between parties.

The company reserves the right to charge surcharges when goods purchased are less than minimum values (G.S.T Exclusive) *See below for further details.*

Delivery Charges: -

Metropolitan

Delivery Next Day to Fixed Addresses  
Free In Store For All Goods Over \$200, Based on Carton Items  
\$25.00 Surcharge Applicable For Goods Less Than \$200

Express Site Deliveries:  
(Sydney Metropolitan Only)  
Small Items

Same Day Delivery - Normally Within Four (4) Hours  
Free In Store for Goods Over \$1000, Based on Carton Items  
For All Goods Over \$600 Site Delivery Fee of \$25 Applicable  
For All Goods Under \$350 Site Delivery Fee of \$45 Applicable

Express Site Deliveries:  
(Sydney Metropolitan Only)  
Long Lengths (Pipes & Strut)  
Items 1.8m and Greater

Same Day Delivery - Normally Within Four (4) Hours  
Free In Store For Goods over \$2,000  
For All Goods Over \$1000 Site Delivery Fee of \$30 Applicable  
For All Goods Over \$600 Site Delivery Fee of \$45 Applicable  
For All Goods Under \$350 Site Delivery Fee of \$60 Applicable

Ph: 02 9525 0970

Fax: 02 9540 2899

Email: orders@arrowsales.com.au

***(Express Incur 100% VIP Surcharge)***



## **Arrow Sales Pty Ltd**

ABN: 47 102 419 152

**39 Cawarra Road  
Caringbah NSW 2229  
Australia**

**Phone: (02) 9525 0970**

**Fax: (02) 9540 2899**

**Email: [orders@arrowsales.com.au](mailto:orders@arrowsales.com.au)**

**Web: [www.tradestore.com.au](http://www.tradestore.com.au)**

**For more information on these products and other Arrow Product lines please contact us, as per details above**

**Authorised Distributor**